



**tubes**

PRICE **75** CENTS

# **essential**

## **characteristics**

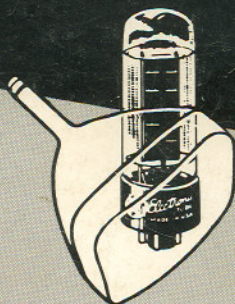

- **RECEIVING TUBES**
- **TELEVISION PICTURE TUBES**
- **SPECIAL-PURPOSE TUBES**

**GENERAL**  **ELECTRIC**



**ESSENTIAL CHARACTERISTICS** is especially prepared to provide the Service Technician with a single source of reference containing data on every tube likely to be found in any home receiver—AM, FM, or television—as well as on some other special-purpose and industrial tubes.

Data presented include those characteristics and ratings essential to fast, efficient trouble-shooting. Basing diagrams for each type are shown on the page with the data.

The electronics engineer, amateur, and experimenter will also find this a valuable quick-reference for tubes currently in use.

Included in the present edition of this handbook are the many new receiving tubes recently announced for use in television applications and a section listing the essential physical and electrical characteristics of television picture tubes. For reference purposes and for the convenience of the user this handbook also contains a section devoted to special-purpose tubes.

A section entitled "Interpretation of Technical Data" is included to aid in the proper evaluation of the information presented in this handbook. Following this section are tube classification charts arranged to provide a quick and convenient reference to the tubes that are available for specific classes of service in which the reader may be interested.

Requests for additional information will receive prompt attention if addressed to:

**TUBE SALES SECTION  
ELECTRONIC COMPONENTS DIVISION  
GENERAL ELECTRIC COMPANY  
SCHENECTADY, NEW YORK**

## TABLE OF CONTENTS

TITLE	PAGE
Interpretation of Technical Data.....	2
Classification Chart—Receiving Tubes.....	7
Characteristics and Ratings	
Receiving Tubes.....	12
Classification Chart—Five-Star Tubes, Special Purpose Tubes.....	123
Special-Purpose Tubes.....	124
Television Picture Tubes.....	152
Outline Drawings	
Standard Configurations.....	178
T-X Table (see page 3).....	188
Characteristic Curves.....	194
Typical Circuits.....	206

*Since the information presented in this handbook is industry-wide in scope, the inclusion of a tube in this publication does not necessarily imply its availability from the General Electric Co.*

# INTERPRETATION OF TECHNICAL DATA

## GENERAL

1. All electrode voltages indicated as "Maximum Ratings" are measured with respect to a fixed reference point defined as follows:
  - A. For cathode types, the reference point is the cathode terminal.
  - B. For filamentary types operated on direct current, the reference point is the negative terminal of the filament.
  - C. For filamentary types operated on alternating current, the reference point is the electrical center of the filament.
2. All other electrode voltages indicated are measured with respect to a fixed reference point defined as follows:
  - A. For cathode types not rated with cathode bias, the reference point is the cathode terminal.
  - B. For cathode types rated with cathode bias, the reference point is the negative terminal of the cathode-bias resistor.
  - C. For filamentary types operated on direct current, the reference point is the negative terminal of the filament.
  - D. For filamentary types operated on alternating current, the reference point is the electrical center of the filament.
3. Unless otherwise specified, all values of voltage and current are d-c and positive.

## TUBE TYPE

1. Within each of the data sections of this handbook, data are presented by type designation.
2. Within the receiving tube section, types having the same basic designation, but differing in suffix (e.g., 6BG6-G and 6BG6-GA) are grouped together when the types have equivalent electrical characteristics. All of the information presented applies to each type in the group with the possible exception of the information under the outline drawing, capacitance, or heater voltage and current columns. When this information differs, the values are horizontally aligned with the type designations to which they apply.
3. The use of the suffix GT/G on small glass receiving tubes has been eliminated, and this suffix does not appear in this handbook. Data on GT/G types may be obtained by referring to the data under the GT listing (e.g., characteristics of the 6J5-GT/G will be found under the 6J5-GT listing).
4. The following suffix letters are in common use in tube designations and have the indicated significance:
  - A. G signifies a glass bulb and an octal base.
  - B. GT signifies a T-9, straight-sided glass bulb and an octal base.
  - C. A, B, C, D, E and F assigned in that order signify a later and modified version which can be substituted for any previous version but not vice-versa. The assignment of a suffix in this series does not convey any information as to the nature of the modification incorporated.
  - D. X signifies a base composed of special low-loss material.
  - E. Y signifies a base composed of special intermediate-loss material.

## CLASSIFICATION BY CONSTRUCTION

The column "Classification by Construction" presents a descriptive title for each tube. When the tube represents an improved or modified version of an older type, the older type is given in parenthesis following the descriptive title. The inclusion of the older type in parenthesis is given as an aid in identifying the general characteristics of the tube under consideration and does not necessarily imply direct interchangeability between the two. Whether or not the tubes can be used interchangeably depends on the particular characteristics and requirements of each individual application.



## BASE CONNECTIONS

1. The basing diagrams are shown on the same page as the data of the type to which they refer and are shown as bottom views. These diagrams are schematic representations of the terminal connections and do not necessarily indicate internal tube construction.
2. Pin number 1 on metal receiving tubes is usually connected to the outer shell of the tube. Certain glass tubes with octal bases have internal shields connected to this pin. For correct operation of octal-based tubes, pin number 1 should never be used as a terminal for any voltage or portion of the electrical circuit, but should be connected to ground whenever possible.
3. In tubes having more than one grid, the grids are numbered consecutively in accordance with their location proceeding from the cathode to the plate. Thus, grid number 1 is the grid which is physically located nearest the cathode. In pentodes, grid number 2 is generally referred to as the screen grid, and grid number 3 is generally referred to as the suppressor grid.
4. In multisection tubes which contain two or more structurally similar sections, the similar sections are designated as section 1, section 2, etc., depending upon the connection of the plates to the terminal pins. The highest-numbered section is defined as that section whose plate connects to the lowest-number base pin; similarly, the second highest-numbered section is that section whose plate connects to the second lowest-number base pin, etc.

## OUTLINE DRAWINGS

This column presents information on the physical characteristics of each tube. When the physical characteristics of a tube conform to standard or commonly used configurations, an outline drawing number is shown which refers to tube drawings presented in the section "Outline Drawings." If the physical characteristics of a tube do not conform to any of the standard outline drawings, the designation "T-X" is shown. In this case, reference should be made to the T-X Table in the Outline Drawings Section which presents data relative to the physical characteristics of these special tubes.

## FILAMENT VOLTAGE

Unless otherwise specified under the column "Filament Volts," the heater or filament of any tube may be operated with either alternating or direct current.

## CAPACITANCES

1. Unless otherwise noted, all capacitance values in this publication are average values and those for glass tubes are measured with an external close-fitting metal shield connected to the cathode terminal.
2. All capacitance values indicated herein are measured with the filament or heater cold and with no direct voltages applied.
3. In measuring the capacitances listed below, all metal parts except the input and output electrodes are connected to the cathode. These metal parts include internal and external shields, base sleeves, and unused pins. In multisection tubes, the electrodes of the sections not common to the section under test are connected to ground.
  - A. Input capacitance is measured from the input grid to all other electrodes except the plate, which is connected to ground.
  - B. Output capacitance is measured from the plate to all other electrodes except the input grid, which is connected to ground.
  - C. Grid-plate capacitance is measured from the input grid to the plate with all other electrodes connected to ground.
4. The capacitance values for twin-section tubes refer to each section unless otherwise specified.

## TYPICAL OPERATING CONDITIONS

1. The column headed "Service," indicates the principal application of the type. The columns to the right of this show average tube characteristics and typical operating conditions for the service indicated. These values are presented

to show concisely some guiding information as to the use and characteristics of each type. They are not to be considered as maximum ratings because the tube can be used under any suitable conditions within its rating limitations.

2. The classes of amplifier service indicated are defined as follows:
  - A. A Class A Amplifier is an amplifier in which the grid bias and applied alternating grid voltage are such that plate current in a specific tube flows at all times.
  - B. A Class AB Amplifier is an amplifier in which the grid bias and applied alternating grid voltage are such that plate current in a specific tube flows for appreciably more than half but less than the entire electrical cycle.
  - C. A Class B Amplifier is an amplifier in which the grid bias is approximately equal to the cutoff value so that the plate current is approximately zero when no exciting grid voltage is applied, and so that plate current in a specific tube flows for approximately one half of each cycle when an alternating grid voltage is applied.
  - D. A Class C Amplifier is an amplifier in which the grid bias is appreciably greater than the cutoff value so that the plate current in each tube is zero when no alternating grid voltage is applied, and so that plate current in a specific tube flows for appreciably less than one half of each cycle when an alternating grid voltage is applied.
  - E. To denote that grid current does not flow during any part of the input cycle, the suffix 1 may be added to the letter or letters of the class identification. The suffix 2 may be used to denote that grid current flows during some part of the cycle.
3. The values of the tube characteristics presented are the average values based on large groups of tubes. Any individual tube may vary from these over-all averages.
4. Unless otherwise noted, all ratings and characteristics for rectifier tubes apply to operation with a capacitor-input filter. In general, operation with a choke-input filter allows the use of a slightly higher RMS supply voltage.
5. For power output tubes, the value under the column "Power Output, Watts" refers to the average tube power output (plate input power minus plate dissipation) for the indicated operating conditions. To determine the useful power output, subtract the circuit losses from the tube output. In Class A operation, the rated tube power output is measured with an AF sinusoidal input signal whose peak value is equal to the d-c grid-number one bias voltage applied to the tube.
6.
  - A. The plate resistance ( $R_p$ ) of an electronic tube is the ratio of a small change in plate voltage to the corresponding change in plate current with all other electrode voltages maintained constant.
  - B. The transconductance ( $G_m$ ) of an electronic tube is the ratio of a small change in plate current to the small change in grid voltage that produces it with all other electrode voltages maintained constant. Unless otherwise noted all transconductance values in this handbook are grid 1-to-plate transconductances.
  - C. The amplification factor ( $\mu$ ) of an electronic tube is the ratio of a small change in plate voltage to the small change in grid voltage when the plate current and all other electrode voltages are maintained constant.
  - D. The conversion transconductance of a converter or mixer tube is the ratio of a small change in the output intermediate-frequency current to the small change in input radio-frequency voltage producing it.

## MAXIMUM RATINGS

Unless otherwise specified, the maximum tube ratings have been prepared in accordance with the RETMA system of Design-Center Maximums and should be interpreted as defined in paragraphs 1 and 2 given below.

### 1. Cathode

The heater or filament voltage is given as a normal value unless stated otherwise. This means that transformers or resistances in the heater or filament circuit should be designed to operate the heater or filament at rated value for full-load operating conditions under average supply-voltage conditions. A reasonable

amount of leeway is incorporated in the cathode design so that moderate fluctuations of heater or filament voltage downward will not cause marked falling off in response; also, moderate voltage fluctuations upward will not reduce the life of the cathode to an unsatisfactory degree.

### **A. 1.4-volt Battery Tube Types**

The filament power supply may be obtained from dry-cell batteries, from storage batteries, or from a power line. With dry-cell battery supply the filament may be connected either directly across a battery rated at a terminal potential of 1.5 volts, or in series with the filaments of similar tubes across a power supply consisting of dry cells in series. In either case, the voltage across each 1.4-volt section of filament should not exceed 1.6 volts. With power-line or storage-battery supply, the filament may be operated in series with the filaments of similar tubes. For such operation, design adjustments should be made so that, with tubes of rated characteristics operating with all electrode voltages applied and on a normal line voltage of 117 volts, or on a normal storage-battery voltage of 2.0 volts per cell (without a charger), or 2.2 volts per cell (with a charger), the voltage drop across each 1.4-volt section of filament will be maintained within a range of 1.25 to 1.4 volts with a nominal center of 1.3 volts. In order to meet the recommended conditions for operating filaments in series from dry batteries, storage batteries, or power-line sources it may be necessary to use shunting resistors across the individual 1.4-volt sections of filament.

## **2. Positive Potential Electrodes**

The power sources for the operation of radio equipment are subject to variations in their terminal potential. Consequently, the maximum ratings given have been established for certain design-center voltages which experience has shown to be representative. The design-center voltages to be used for the various power supplies together with other rating considerations follow.

### **A. AC or DC Power-line Service in U.S.A.**

The design-center voltage for this type of power supply is 117 volts. The maximum ratings of plate voltages, screen-supply voltages, dissipations, and rectifier output currents are design maximums and should not be exceeded in equipment operated at a line voltage of 117 volts.

### **B. Storage-battery Service**

When storage-battery equipment is operated without a charger, it should be so designed that the published maximum values of plate voltages, screen-supply voltages, dissipations, and rectifier output currents are never exceeded for a terminal potential at the battery source of 2.0 volts per cell. When storage-battery equipment is operated with a charger, it should be so designed that 90 percent of the same values are never exceeded for a terminal potential at the battery source of 2.2 volts per cell.

### **C. B-Battery Service**

The design-center voltage for B-batteries is the normal voltage rating of the battery block, such as 45 volts, 90 volts, etc. Equipment should be so designed that under no condition of battery voltage will the plate voltages, the screen-supply voltages, or dissipations ever exceed the recommended respective maximum values shown in the data for each tube type by more than 10 percent.

## **D. Other Considerations**

### **a. Class A Amplifiers**

The maximum plate dissipation occurs at the zero-signal condition. The maximum screen dissipation usually occurs at the condition where the peak-input signal voltage is equal to the bias voltage.

### **b. Class B Amplifiers**

The maximum plate dissipation theoretically occurs at approximately 63

percent of the maximum-signal condition, but practically may occur at any signal-voltage value.

### **c. Converters**

The maximum plate dissipation occurs at the zero-signal condition and the frequency at which the oscillator-developed bias is a minimum. The screen dissipation for any reasonable variation in signal voltage must never exceed the rated value by more than 10 percent.

### **d. Screen Ratings**

The maximum screen-voltage rating may be exceeded provided that all the following conditions are satisfied:

1. At any operating condition the screen voltage does not exceed the maximum plate-voltage rating.
2. At any operating condition the average screen dissipation does not exceed the maximum rating.
3. At the operating condition which results in maximum screen current, the screen voltage does not exceed the value required for maximum screen dissipation. This condition, however, may not represent the maximum dissipation condition.

## **3. Absolute-Maximum Ratings**

In some instances, the maximum ratings are specified as Absolute-Maximum Ratings. The Absolute-Maximum Ratings are limiting values beyond which the serviceability of the tube may be impaired from the viewpoint of life and satisfactory performance. In order not to exceed these Absolute-Maximum Ratings, the equipment designer must establish the circuit design so that initially and throughout tube and equipment life, no Absolute Maximum value is exceeded under the worst probable operating conditions with respect to supply-voltage variation, equipment component variation, equipment control adjustment, load variation, signal variation, environmental conditions, and variation in tube characteristics.

## **4. Design-Maximum Ratings**

For some types, the maximum ratings are specified as Design-Maximum Ratings. The Design-Maximum Ratings are the limiting values expressed with respect to bogie tubes at which satisfactory tube life can be expected to occur for the types of service for which the tube is rated. Therefore, the equipment designer must establish the circuit design so that initially and throughout equipment life no Design-Maximum value is exceeded with a bogie tube under the worst probable operating conditions with respect to supply-voltage variation, equipment component variation, equipment control adjustment, load variation, signal variation, and environmental conditions.



# CLASSIFICATION CHART

## Receiving Types

Type designations of miniature tubes are shown in *italics*.  
Type designations of metal tubes are shown in **boldface** type.

### DIODES

Service	Max. Output Current in Ma.	Single		Twin		Triple Cath
		Fil	Cath	Fil	Cath	
TV High-Voltage Rectifiers	0.5	<i>1AX2</i> <i>1B3-GT</i> <i>1V2</i> <i>1X2-A</i> <i>1X2-B</i> <i>2B3</i>				
	1.0 to 1.5	<b>3C2</b>	<i>3A2</i> <i>3A3</i> <i>3B2</i>			
	1.0 Per Plate					<i>6BJ7</i>
Low-Current Rectifiers	8.0 to 10 Per Plate			<i>3AL5</i> <i>7A6</i> <i>6AL5</i> <i>12AL5</i> <b>6H6</b> <b>12H6</b>		
	12 Per Plate					<i>6BC7</i>
	40 to 49		1-V			
Power Rectifiers	50 to 99		<i>117Z3</i>		<i>OZ4</i> <i>7Y4</i> <i>OZ4-G</i> <i>12X4</i> <i>6X4</i> <i>84/6Z4</i> <i>6X5-GT</i>	
	100 to 149		<i>35W4</i> <i>35Y4</i> <i>35Z3</i> <i>35Z5-GT</i>	<i>5A4</i> <i>5Y3-GT</i> <i>5Y4-GT</i> <b>80</b>	<i>OZ4-A</i> <i>6AX5-GT</i> <b>7Z4</b>	
	150 to 199				<i>5V4-GA</i> <i>6BY5-G</i>	
	200 to 249			<i>5U4-G</i> <i>5Z3</i> <b>83</b>		
	250 to 299			<i>5AS4</i> <i>5AW4</i> <i>5U4-GA</i> <i>5U4-GB</i> <b>5AU4</b>		
	300 to 349					
	60 to 75 Per Plate				<i>25Z5</i> <i>50Y6-GT</i> <i>25Z6-GT</i> <i>50Y7-GT</i> <i>50X6</i> <i>117Z6-GT</i>	
TV Damping Diodes	75		<i>17H3</i>			
	125		<i>6AX4-GT</i> <i>6W4-GT</i> <i>12AX4-GTA</i> <i>17AX4-GT</i> <i>25AX4-GT</i> <i>25W4-GT</i>			
	135		<i>6V3-A</i>			
	175				<i>6BY5-G</i>	
	190		<i>6AU4-GTA</i> <i>19AU4-GTA</i>			

### TRIODES

μ	Single					Twin or Double				
	Heater Current in Milliamperes					Heater Current in Milliamperes				
	600	450	300	150	Other	600	450	300	150	Other
2.0 to 9.0	<i>12B4-A</i>		<i>12B4-A</i>		<i>2A3</i> <i>6AH4-GT</i> <i>6B4-G</i>					<i>6AS7-G</i> <i>6AS7-GA</i>
10 to 19	<i>2AF4</i> <i>2AF4-A</i> <i>6S4-A</i>	<i>3AF4-A</i>		<i>6C4</i>	<i>6AF4</i> <i>6AF4-A</i> <i>6T4</i>	$\frac{1}{2}$ <i>6CM7</i> <i>7AU7</i> <i>12BH7</i> <i>12BH7-A</i>	$\frac{1}{2}$ <i>8CM7</i> <i>9AU7</i>	<i>7AF7</i> <i>7AU7</i> <i>12AU7</i> <i>12AU7-A</i> <i>12BH7</i> <i>12BH7-A</i>	<i>12AU7</i> <i>12AU7-A</i> <i>14AF7</i>	<i>6BL7-GT</i> <i>6BX7-GT</i> <i>9AU7</i>

## TRIODES (Cont'd)

μ	Single					Twin or Double				
	Heater Current in Milliamperes					Heater Current in Milliamperes				
	600	450	300	150	Other	600	450	300	150	Other
20 to 29	12A4		6C5 6J5 7A4 12A4	12J6		6CG7 ½ 8CM7 6F8-G 6SN7-GTB 7N7	8CG7 ½ 8CM7	12SN7-GTA		12G8
30 to 39						4BC8 4BQ7-A 4BZ7 5J6	5BQ7-A 5BZ7 6J6 6J6-A	6C8-G		6BC8 6BQ7-A 6BS8 6BZ7 6N7
40 to 49	2BN4	5BN4			6AJ4 6BN4	6BK7-A	6BK7-A 6BK7-B 12AV7	7F8		6BZ8 12AV7
60 to 69				6AB4			12AZ7	12AT7	12AT7	12AZ7
70 to 79								6SC7 6SL7-GT 7F7	12SC7 12SL7-GT	
80 to 89				6AM4						
100			6F5 6SF5 7B4	12SF5		12BZ7		12AX7 12BZ7	12AX7	

## TRIODES WITH DIODES

μ		Heater Current in Milliamperes				
		600	450	300	150	Other
15 to 40	With 2 Diodes	6BV8		6BF6 6SR7	12AE6 12AJ6 12BF6 12SR7	
	With 1 Diode					1H5-GT 1LH4
60 to 70	With 2 Diodes	6CN7	8CN7 12BR7	6AQ7-GT 6AT6 6CN7 6Q7 7K7	6A06 12AT6 12Q7-GT	8CN7 12BR7
	With 3 Diodes	5T8	6T8 6T8-A		19T8	
	With 2 Diodes	3AV6		6AV6 6SQ7 7B6 7X7 75	7C6 12AV6 12SQ7 14B6	
100	With 3 Diodes			6S8-GT		

## PENTODE POWER AMPLIFIERS

Service	Power Output in Watts	Heater Current in Milliamperes				
		600	450	300	150	Other
Output Amplifiers	0.1 to 0.4					1A5-GT 3Q4 1LB4 3Q5-GT 1S4 3S4 3LF4 3V4
	1.0 to 1.9	12C5 12CA5 12CU5	17C5	26C5 26CA5	6AK6 35B5 35C5 50B5 50C5	6BF6 6CA5
	2.0 to 2.9			43		6AS5 6CL6

## PENTODE POWER AMPLIFIERS (Cont'd)

Service	Power Output in Watts	Heater Current in Milliamperes				
		600	450	300	150	Other
Output Amplifiers	3.0 to 3.9	12BK5 12L6-GT 12W6-GT		25BK5 25L6-GT 25W6-GT	12A6 35A5 35L6-GT 50A5 50L6-GT	6AG7 6W6-GT 6AR5 7B5 6BK5 41 6K6-GT
	4.0 to 6.0	5AQ5 5V6-GT	6AQ5 6AQ5-A 6CM6 6V6 6V6-GT 7C5			6F6 12AB6 6F6-GT 12AQ6 6Y8-G 12V6-GT 6Y6-GT 42
	10.0 to 11.0					6L6 6L6-GB
Horizontal-Deflection Amplifiers		12AV5-GA 12BQ6-GA 12CU6 12DQ6 25CD6-GB 25DN6	17AV5-GA 17DQ6	18A5 19BG6-GA 25AV5-GA 25BQ6-GA 25CU6 25DQ6		6AU5-GT 6BQ6-GT 6AV5-GA 6CD6-GA 6BG6-GA 6CU6 6BQ6-GA 6DQ6

## PENTODE VOLTAGE AMPLIFIERS

G <sub>m</sub> , μmhos	Sharp-Cutoff					Remote-Cutoff				
	Heater Current in Milliamperes					Heater Current in Milliamperes				
	600	450	300	150	Other	600	450	300	150	Other
500 to 900	3DT6	4DT6	6DT6		1LN5 1N5-GT 1U4				12AC6	1T4
1000 to 1900			6C6 6J7 6SJ7	7C7 12AF6 12SJ7	1L4			6D6 6K7 78	6SS7 7B7 12BL6 12K7-GT	
2000 to 2900								6BD6 6SK7 7A7	12BD6 12SK7 14A7	
3000 to 3900									6BJ6	
4000 to 4900			6SH7	6BH6 7AG7 12SH7		3BA6		6BA6 6SG7 7H7	12BA6 12SG7	
5000 to 5900	3AU6 3BC5	4BC5 7V7	6AG5 6AU6 6AU6-A 6BC5	12AU6 12AW6	6AK5					
7000 to 7900	3CE5 3CF6	4CE5	6CE5 6CF6							
8000 to 8900	3CB6	4CB6	6CB6 6CB6-A 6DE6			3BZ6		6BZ6		
9000 to 9900			6AC7 6AH6							
11000 to 13000	12BV7 12BY7-A		12BV7 12BY7-A							

## PENTODES WITH DIODES

Classification		Heater Current in Milliamperes				
		600	450	300	150	Other
Sharp-Cutoff Pentodes	With 1 Diode	5AM8 5AS8	6AM8 6AS8	6SV7		1LD5 1S5 1U6
	With 2 Diodes					
Remote-Cutoff Pentodes	With 1 Diode			6CR6 6SF7	12CR6 12SF7	
	With 2 Diodes			6B8	12F8	
Pentode Power Amplifiers with Half-Wave Rectifier						117L7-GT 117N7-GT 117P7-GT

**TRIODE-PENTODES**

Transconductance, Pentode Section	Amplification Factor, Triode Section	Heater Current in Milliamperes		
		600	450	300
1100	8.0			6F7
4600	40	5AT8 5CG8 5X8	6AT8 6CG8 6CG8-A 6X8 6X8-A	
5200	40	5BE8 5BR8 5U8	6BR8 6U8 6U8-A	9U8-A
6000	19		6AZ8	
6200	19	5AN8 5AV8 5B8	6AN8	
7000	17	6BH8	8BH8	
	40	6AU8	8AU8	12CT8
8000	53			10C8
9000	18	6BA8-A	8BA8-A	
	70	6AW8-A	8AW8-A	

**HEPTODES**

Service	Conversion Transconductance in Micromhos	Heater Current in Milliamperes				
		600	450	300	150	Other
Converters	250 to 300				12AD6 12AG6	1A7-GT 1L6 1LA6 1LC6 1R5
	450 to 550	3BE8		6A7 6A8 6BE8 6SA7 7B8 7Q7	12BE6 12SA7 14Q7	
	900 to 1000			6BA7	12BA7	
Dual-Control Amplifiers		3BY6 3CS6		6BY6 6CS6		

**MULTISECTION AND MISCELLANEOUS TYPES**

Classification	Heater Current in Milliamperes				
	600	450	300	150	Other
Triode-Hexodes			6K8		
Triode-Heptodes			7J7 7S7		
Twin Pentodes	3BU8	4BU8	6BU8		28D7
Space-Charge-Grid Tetrode					12K5
Triode-Tetrodes	6CL8	6CL8			
Octodes				7A8	
Electron-Ray Indicators			6E5 6U5	6AF6-G 6AL7-GT	
Gated-Beam Tubes	3BN6	4BN6	6BN6	12BN6	
Sheet-Beam Tubes			6AR8		





Tube Type	Classification by Construction	Base Connections	Outline Dwg	Filament Volts	Filament Amp	Max Plate Watts	Max Plate Volts	Max Screen Volts	Capacitance in Micromicrofarads		
									Input	Output	Grid-plate
OOA	Triode Detector	4D	14-1	5.0 DC	0.25	—	45	—	3.2	2.0	8.5
O1-A	Low-Mu Triode	4D	14-1	5.0 DC	0.25	—	135	—	3.1	2.2	8.1
<i>OA#</i>	Glow-Discharge Diode Voltage Regulator	5BO	5-3	—	—	—	Anode supply = 185 volts d-c min				
OA3	Glow-Discharge Diode Voltage Regulator	4AJ	12-7	—	—	—	Anode supply = 105 volts d-c min				
OA4-G	Gas Triode	4V	12-7	—	—	—	—	—	—	—	—
<i>OB#</i>	Glow-Discharge Diode Voltage Regulator	5BO	5-3	—	—	—	Anode supply = 133 volts d-c min				
OB3	Glow-Discharge Diode Voltage Regulator	4AJ	12-7	—	—	—	Anode supply = 125 volts d-c min				
OC3	Glow-Discharge Diode Voltage Regulator	4AJ	12-7	—	—	—	Anode supply = 133 volts d-c min				
OD3	Glow-Discharge Diode Voltage Regulator	4AJ	12-7	—	—	—	Anode supply = 185 volts d-c min				
<b>OY4</b> <i>OY4-G</i>	Half-Wave Gas Rectifier	4BU	8-1 T-X	—	—	—	Pins 7 and 8 must be connected;				
<b>OZ4</b> <i>OZ4-G</i>	Full-Wave Gas Rectifier	4R	8-3 T-X	—	—	—	—	—	—	—	—
<b>OZ4-A</b>	Full-Wave Gas Rectifier	4R	8-1	—	—	—	—	—	—	—	—
<b>1A5</b>	High-Frequency Diode	5AP	5-2	1.4	0.15	—	—	—	—	—	—
<b>1A4-p</b> <b>1A4-t</b>	Remote-Cutoff RF Pentode	4M 4K	12-6	2.0 DC	0.06	—	180	67.5	5.0▲	11.0▲	0.007
<b>1A5-GT</b>	Power Amplifier Pentode	6X	9-11	1.4 DC	0.05	—	110	110	—	—	—
<b>1A6</b>	Pentagrid Converter	6L♠	12-6	2.0 DC	0.06	—	180	67.5	Osc I <sub>g1</sub> = 0.2 ma R <sub>g1</sub> = 50,000 ohms		
<b>1A7-G</b> <b>1A7-GT</b>	Pentagrid Converter	7Z♠	9-28 9-18	1.4 DC	0.05	—	110	60	Osc I <sub>g1</sub> = 0.035 ma R <sub>g1</sub> = 200,000 ohms		
<b>1A85</b>	Remote-Cutoff RF Pentode	5BF	9-32	1.2 DC	0.130	1.0	150	150	2.8	4.2	0.25 ♣
<b>1A86</b>	Pentagrid Converter	7DH	T-X	1.4 DC	0.025	0.15	90	90	Osc I <sub>g1</sub> = 85 μa R <sub>g1</sub> = 27,000 ohm		

Metal tubes are shown in bold-face type, miniature tubes in italics.

♣Subminiature type.

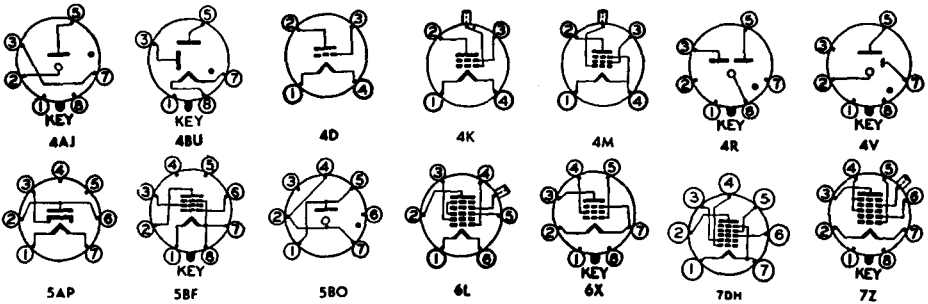

Service	Plate Volts	Screen Volts	Neg Grid Volts	Plate Milli-am-peres	Screen Milli-am-peres	R <sub>p</sub> , Ohms	G <sub>m</sub> , μmhos	μ Fac-tor	Load for Rated Out-put, Ohms	Power Out-put, Watts	Tube Type
Detector	45	—	0	1.5	—	30,000	666	20	—	—	00A
Class A Amplifier	135	—	9.0	3.0	—	10,000	800	8	—	—	01-A
{ d-c operating current = 5 ma min } Ionization voltage = 155 volts d-c § { d-c operating current = 30 ma max } Operating voltage = 150 volts d-c § Regulation (5 to 30 milliamperes) = 2.0 volts						0A#					
{ d-c operating current = 5 ma min } Ionization voltage = 100 volts d-c § { d-c operating current = 40 ma max } Operating voltage = 75 volts d-c § Regulation (5 to 40 milliamperes) = 5.0 volts						0A3					
Peak cathode current = 100 ma max; d-c cathode current = 25 ma max; Starter anode drop = 55 volts §; anode drop = 70 volts §											
{ d-c operating current = 5 ma min } Ionization voltage = 115 volts d-c § { d-c operating current = 30 ma max } Operating voltage = 105 volts d-c § Regulation (5 to 30 milliamperes) = 1.0 volts						0B#					
{ d-c operating current = 5 ma min } Ionization voltage = 110 volts d-c § { d-c operating current = 40 ma max } Operating voltage = 90 volts d-c § Regulation (5 to 40 milliamperes) = 8.0 volts						0B3					
{ d-c operating current = 5 ma min } Ionization voltage = 115 volts d-c § { d-c operating current = 40 ma max } Operating voltage = 105 volts d-c § Regulation (5 to 40 milliamperes) = 2.0 volts						0C3					
{ d-c operating current = 5 ma min } Ionization voltage = 160 volts d-c § { d-c operating current = 40 ma max } Operating voltage = 150 volts d-c § Regulation (5 to 40 milliamperes) = 4.0 volts						0D3					
peak current = 500 ma max; d-c output current = 75 ma max, 40 ma min; max starting voltage = 95 volts d-c; peak inverse voltage = 300 volts max											
Starter supply voltage per plate = 300 peak volts min; max d-c output = 75 milliamperes; peak current per plate = 200 milliamperes											
Full-Wave Rectifier	Max d-c output current = 110 ma; minimum d-c output current = 30 ma; max peak inverse voltage = 880 volts; minimum starter supply voltage per plate = 300 volts; max peak plate current per plate = 330 ma										0Z4-A
Half-Wave Rectifier	Max d-c output current = 0.5 ma; max peak inverse voltage = 330 volts; rms supply voltage = 117 volts; max peak current = 5.0 ma										1A3
Class A Amplifier	180	67.5	3	2.3	0.8	1,000,000	750	—	—	—	1A4-p 1A4-t
Class A Amplifier	90 85	90 85	4.5 4.5	4.0† 3.5†	0.8† 0.7†	300,000 300,000	850 800	— —	25,000 25,000	0.115 0.100	1A5-GT
Converter	180	67.5	3.0	1.3	2.4	500,000§	300 #	E <sub>ca</sub> (Osc Plate) = 180 thru 20,000 ohms I <sub>ca</sub> = 2.3 ma			1A6
Converter	90	45	0	0.6	0.7	600,000§	250 #	E <sub>ca</sub> (Osc Plate) = 90 I <sub>ca</sub> = 1.2 ma			1A7-G 1A7-GT
Class A Amplifier	150 90	150 90	1.5 R <sub>g</sub> = 1.0 Meg	6.8 3.5	2.0 0.8	125,000§ 275,000§	1350 1100	—	—	—	1AB5
Converter	64	64	0	0.6	0.16	900,000§	275 #	E <sub>ca</sub> (Osc Plate) = 35 thru 18,000 ohms I <sub>ca</sub> = 1.6 ma			1AB6

§ Approximate.

▲ Without external shield.

† Zero signal.

‡ Grids 3 and 5 are screen. Grid 4 is signal-input grid.

# Conversion transconductance.

◆ Maximum.

▼ Grids 2 and 4 are screen. Grid 3 is signal-input grid.

\* Screen supply voltage.

⊗ Absolute maximum rating.

‡ Plate-to-plate.

◆ Per section.

⊗ Design maximum rating.

⊗ For both sections.

\* Minimum.

¶ Heater warm-up time controlled for series-string service.

§ Plate supply voltage.

|| Input plate.

‡ The duration of the pulse voltage must not exceed 15 percent of one scanning cycle.

1—Section 1.

2—Section 2.

4—A resistor of 3 ohms must be put in series with heater.

Tube Type	Classification by Construction	Base Connections	Out-line Dwg	Filament Volts	Filament Amp	Max Plate Watts	Max Plate Volts	Max Screen Volts	Capacitance in Micromicrofarads		
									Input	Out-put	Grid-plate
<b>1AC5</b> ●	Power Amplifier Pentode	8CP	3-5	1.25 DC	0.04	—	67.5	67.5	—	—	—
<i>1AC6</i>	Pentagrid Converter	7DH	5-2	1.4 DC	0.05	0.15	90	90	Osc $I_{g1} = 0.13$ ma $R_{g1} = 27,000$ ohms		
<b>1AD4</b> ●	Sharp-Cutoff RF/AF Pentode	1AD4	2-1	1.25 DC	0.1	—	45	45	4.5	4.5	0.01 ♣
<b>1AD5</b> ●	Sharp-Cutoff RF Pentode	8CP	3-5	1.25 DC	0.04	—	67.5	67.5	1.9	3.0	0.009 ♣
<i>1AE4</i>	Sharp-Cutoff RF Pentode	6AR	5-2	1.25 DC	0.1	—	90	90	3.6	4.4	0.008 ♣
<b>1AE5</b> ●	Heptode Mixer	1AE5 ▼	T-X	1.25 DC	0.06	—	45	45	$I_{g1}$ (Injection) = 15 $\mu$ a $R_{g1} = 200,000$ ohms		
<i>1AF4</i>	Sharp-Cutoff Pentode	6AR	5-2	1.4 DC	0.025	—	110	90	3.8	7.6	0.009 ♣
<i>1AF5</i>	Diode, Sharp-Cutoff Pentode	6AU	5-2	1.4 DC	0.025	—	110	110	2.5	4.8	0.17
<b>1AG4</b> ●	Power Amplifier Pentode	512AX	2-1	1.25 DC	0.04	—	90	90	—	—	—
<b>1AG5</b> ●	Diode-Pentode	1AJ5	2-1	1.25	0.03	—	50 □	50 □	—	—	—
<b>1AH4</b> ●	RF Pentode	1AD4	2-1	1.25 DC	0.04	—	90	90	3.5 ▲	4.5 ▲	0.01 ♣ ▲
<i>1AH5</i>	Diode Sharp-Cutoff AF Pentode	6AU	T-X	1.4 DC	0.025	0.03	90	90	—	—	—
<i>1AJ4</i>	Remote-Cutoff RF Pentode	6AR	T-X	1.4 DC	0.025	0.25	90	90	3.3	7.8	0.01 ♣
<b>1AJ5</b> ●	Diode Sharp-Cutoff Pentode	1AJ5	2-1	1.25 DC	0.04	—	90	90	1.7	2.4	0.10
<b>1AK4</b> ●	Sharp-Cutoff RF Pentode	1AK4	2-1	1.25 DC	0.02	—	90	90	3.5 ▲	4.5 ▲	0.01 ♣ ▲
<b>1AK5</b> ●	Diode Sharp-Cutoff Pentode	1AJ5	2-1	1.25 DC	0.02	—	90	90	2.0	2.7	0.10 ♣
<i>1AM4</i>	Remote-Cutoff RF Pentode	6AR	5-2	1.4 DC	0.025	—	90	67.5	3.6 ▲	7.5 ▲	0.01 ♣
<i>1AQ5</i>	Pentagrid Converter	7AT ▼	5-2	1.4 DC	0.025	—	90	67.5	Osc $I_{g1} = 0.14$ ma $R_{g1} = 100,000$ ohms		
<i>1AR5</i>	Diode Sharp-Cutoff Pentode	6AU	5-2	1.4 DC	0.025	—	90	90	—	—	—
<i>1AS5</i>	Diode Sharp-Cutoff Pentode	6BW	5-2	1.4 DC	0.025	—	90	90	—	—	—
<i>1AX2</i>	Half-Wave High-Voltage Rectifier	9Y	6-7	1.4	0.65	—	Tube Voltage Drop:‡ 200 v at 7 ma d-c				

Metal tubes are shown in bold-face type, miniature tubes in italics.

●Subminiature type.



**1AD4**



**1AE5**



**1AJ5**

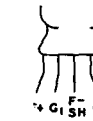

**1AK4**



**6AR**



**6AU**

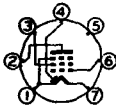

**6BW**

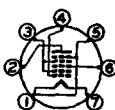

**7AT**

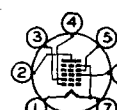

**7DH**

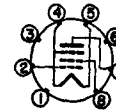

**8CP**

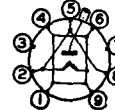

**9Y**



**512-AX**



Service	Plate Volts	Screen Volts	Neg Grid Volts	Plate Milli-amperes	Screen Milli-amperes	R <sub>p</sub> , Ohms	G <sub>m</sub> , μmhos	μ Factor	Load for Rated Output, Ohms	Power Output, Watts	Tube Type
Class A Amplifier	67.5 45 30	67.5 45 30	4.5 3.0 2.0	2.0 1.0 0.5	0.4 0.2 0.1	150,000§ 170,000§ 200,000§	750 600 450	— — —	25,000 40,000 50,000	0.050 0.015 0.005	1AC5 ●
Converter	63.5	63.5	0	0.7	0.15	900,000§	300 #	E <sub>c2</sub> (Osc Plate) = 30 thru 22,000 ohms I <sub>c2</sub> = 1.55 ma			1AC6
Class A Amplifier	45	45	R <sub>g1</sub> = 2 meg	3.0	0.8	500,000§	2000	—	—	—	1AD4 ●
Class A Amplifier	67.5 30	67.5 30	0 0	1.85 0.45	0.75 0.16	700,000§ 700,000§	735 430	—	—	—	1AD5 ●
Class A Amplifier	90	90	0	3.5	1.2	500,000	1550	—	—	—	1AE4
Mixer	45	45	0	0.9	2.0	200,000§	200 #	—	—	—	1AE5 ●
Class A Amplifier	90 67.5	90 67.5	0 0	1.8 1.2	0.55 0.32	1,800,000§ 2,200,000§	1050 925	—	—	—	1AF4
Class A Amplifier	90 67.5	90 67.5	0 0	1.1 0.7	0.4 0.25	2,000,000§ 2,800,000§	600 550	—	—	—	1AF5
Class A Amplifier	41.4	41.4	3.6	2.4 †	0.6 †	180,000	1,000	—	12,000	0.035	1AG4 ●
Class A Amplifier	45 22.5	45 22.5	2.0 0	0.28 0.17	0.12 0.043	2,500,000 700,000	250 235	—	—	—	1AG5 ●
Class A Amplifier	45	45	R <sub>g1</sub> = 5 meg	0.75	0.2	1,500,000	750	—	—	—	1AH4 ●
Class A Amplifier	85	35 §	R <sub>g1</sub> = 10 meg	0.05	0.015	Amplification = 62		—	1 meg	—	1AH5
Class A Amplifier	64	64	0	1.65	0.55	1,000,000§	750	—	—	—	1AJ4
Class A Amplifier	45	45	R <sub>g1</sub> = 5 meg	1.0	0.3	300,000	425	—	—	—	1AJ5 ●
Class A Amplifier	45	45	R <sub>g1</sub> = 5 meg	0.75	0.2	1,500,000	750	—	—	—	1AK4 ●
Class A Amplifier	45	45	R <sub>g1</sub> = 5 meg	0.5	0.2	400,000	280	—	—	—	1AK5 ●
Class A Amplifier	90	67.5	0	2.4	0.9	500,000§	350	—	—	—	1AM4
Converter	90	45	0	0.64	—	800,000§	250 #	—	—	—	1AQ5
Class A Amplifier	67.5	67.5	0	0.9	0.25	800,000§	500	—	—	—	1AR5
Class A Amplifier	67.5	67.5	0	0.9	0.25	800,000§	500	—	—	—	1AS5
TV Flyback Rectifier <sub>2</sub>	Max d-c output current = 0.5 ma; max inverse voltage (d-c component) = 20,000 volts; max peak current = 45 ma									1AX2	

§ Approximate.

▲ Without external shield.

† Zero signal.

♦ Grids 3 and 5 are screen. Grid 4 is signal-

input grid.

# Conversion transconductance.

◆ Maximum.

♣ Grids 2 and 4 are screen. Grid 3 is signal-

input grid.

\* Screen supply voltage.

‡ Absolute maximum rating.

† Plate-to-plate.

◆ Per section.

◆ Design maximum rating.

⊗ For both sections.

\* Minimum.

¶ Heater warm-up time controlled for series-string service.

§ Plate supply voltage.

|| Input plate.

‡—The duration of the pulse voltage must not exceed 15 percent of one scanning cycle.

1—Section 1.

2—Section 2.

4—A resistor of 3 ohms must be put in series with heater.

Tube Type	Classification by Construction	Base Connections	Out-line Dwg	Filament Volts	Filament Amp	Max Plate Watts	Max Plate Volts	Max Screen Volts	Capacitance in Micromicrofarads		
									Input	Out-put	Grid-plate
1B3-GT	Half-Wave High-Voltage Rectifier	3C	T-X	1.25	0.2	—	Tube Voltage Drop: § 100 v at 7 ma d-c				
1B4-p	Sharp-Cutoff RF Pentode	4M	12-6	2.0 DC	0.06	—	180	67.5	5.0▲	11▲	0.007♣
1B5/25-S	Duplex-Diode Medium-Mu Triode	6M	12-5 or 9-26	2.0 DC	0.06	—	135	—	1.6▲	1.9▲	3.6▲
1B7-G 1B7-GT	Pentagrid Converter	7Z♠	9-28 9-18	1.4 DC	0.1	—	110	65	Osc $I_{g1} = 0.035$ ma $R_{g1} = 200,000$ ohms		
1B8-GT	Diode-Triode Power Amplifier Pentode	8AW	9-17	1.4 DC	0.1	—	110	110	Pentode Section		
							110	—	Triode Section		
1C3	Medium-Mu Triode	5CF	5-2	1.4 DC	0.05	—	110	—	0.9	4.2	1.8
1C5-GT	Power Amplifier Pentode	6X	9-11	1.4 DC	0.1	—	110	110	—	—	—
1C6	Pentagrid Converter	6L♠	12-6	2.0 DC	0.12	0.3	180	67.5	Osc $I_{g1} = 0.2$ ma $R_{g1} = 50,000$ ohms		
1C7-G	Pentagrid Converter	7Z♠	12-8	2.0 DC	0.12	0.3	180	67.5	Osc $I_{g1} = 0.2$ ma $R_{g1} = 50,000$ ohms		
1C8 ●	Pentagrid Converter	8CN ▼	3-2	1.25 DC	0.04	—	67.5	45	Osc $I_{g1} = 0.070$ ma $R_{g1} = 100,000$ ohms		
1D3 ●	Low-Mu High-Frequency Triode	8DN	3-2	1.25 DC	0.3	—	110	—	1.0	1.0	2.6
1D5-Gp	Remote-Cutoff RF Pentode	5Y	12-8	2.0 DC	0.06	—	180	67.5	5.0▲	11.0▲	0.007♣
1D5-Gt	Remote-Cutoff RF Tetrode	5R	12-8	2.0 DC	0.06	—	180	67.5	—	—	—
1D7-G	Pentagrid Converter	7Z♠	12-8	2.0 DC	0.06	—	180	67.5	Osc $I_{g1} = 0.2$ ma $R_{g1} = 50,000$ ohms		
1D8-GT	Diode-Triode Power Amplifier Pentode	8AJ	9-17	1.4 DC	0.1	—	110	110	Pentode Section		
							110	—	Triode Section		
1E3	High-Frequency Medium-Mu Triode	9BG	6-2	1.25 DC	0.22	3.0	150	—	1.25▲	0.75▲	1.5▲
1E4-G	Medium-Mu Triode	5S	9-25	1.4 DC	0.05	—	110	—	2.4	6.0	2.4
1E5-Gp	Sharp-Cutoff RF Pentode	5Y	12-8	2.0 DC	0.06	—	180	67.5	5.0▲	11.0▲	0.007♣

Metal tubes are shown in bold-face type, miniature tubes in italics. ●Subminiature type.

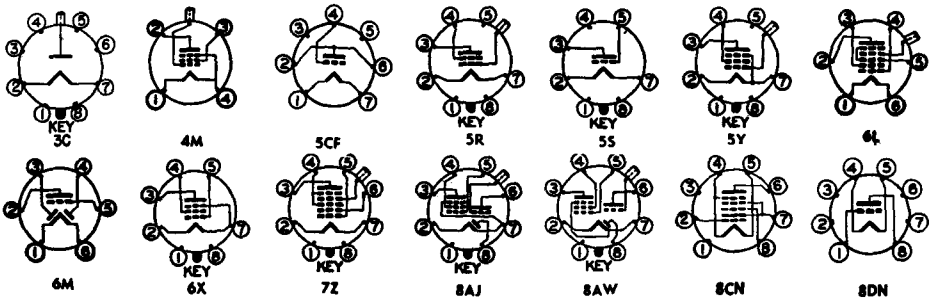

Service	Plate Volts	Screen Volts	Neg Grid Volts	Plate Milli-am-peres	Screen Milli-am-peres	R <sub>p</sub> , Ohms	G <sub>m</sub> , μmhos	μ Factor	Load for Rated Output, Ohms	Power Output, Watts	Tube Type
TV Flyback Rectifier,	Max d-c output current = 0.5 ma; max inverse voltage (d-c component) = 21,000 volts; max peak current = 50 ma Socket terminals 1, 3, 4, 5, 6, and 8 should not be used as tie points.									1B3-GT	
Class A Amplifier	180 90	67.5 67.5	3.0 3.0	1.7 1.6	0.6 0.7	1,500,000 1,000,000	650 600	— —	— —	— —	1B4-p
Class A Amplifier	135	—	3.0	0.8	—	35,000	575	20	—	—	1B5/25-S
Converter	90	45	0	1.5	1.3	350,000§	350 #	E <sub>c2</sub> (Osc Plate) = 90 I <sub>c2</sub> = 1.6 ma		1B7-G 1B7-GT	
Class A Amplifier	90	90	6.0	6.3†	1.4†	—	1,150	—	14,000	0.210	1B8-GT
Class A Amplifier	90	—	0	0.15	—	240,000	275	—	—	—	1C3
Class A Amplifier	90 90	— —	3.0 0	1.4 4.5	—	19,000 11,200	760 1,300	14.5 14.5	—	—	1C5
Class A Amplifier	90 83	90 83	7.5 7.0	7.5† 7.0†	1.6† 1.6†	115,000 110,000	1,550 1,500	— —	8,000 9,000	0.240 0.200	1C5-GT
Converter	180	67.5	3.0	1.5	2.0	700,000§	325 #	E <sub>c2</sub> (Osc Plate) = 180 thru 20,000 ohms I <sub>c2</sub> = 4.0 ma		1C6	
Converter	180	67.5	3.0	1.5	2.0	700,000§	325 #	E <sub>c2</sub> (Osc Plate) = 180 thru 20,000 ohms I <sub>c2</sub> = 4.0 ma		1C7-G	
Converter	67.5	67.5 *	0	1.0	1.5	400,000§	150 #	R <sub>p2</sub> = 20,000 ohms		1C8 ●	
Class A Amplifier	90	—	5.0	12.5	—	—	3,400	8.7	—	—	1D3 ●
Class A Amplifier	180	67.5	3.0	2.3	0.8	1,000,000§	750	—	—	—	1D5-Gp
Class A Amplifier	180	67.5	3.0	2.2	0.7	600,000§	650	—	—	—	1D5-Gt
Converter	180	67.5	3.0	1.3	2.4	500,000§	300 #	E <sub>c2</sub> (Osc Plate) = 180 thru 20,000 ohms I <sub>c2</sub> = 2.3 ma		1D7-G	
Class A Amplifier	90	90	9.0	5.0	1.0	200,000§	925	—	12,000	0.20	1D8-GT
Class A Amplifier	90	—	0	1.1	—	43,500§	575	25	—	—	1E3
Class A Amplifier	150	—	3.5	20	—	—	3,500	14	—	—	1E3
Class A Amplifier	90 90	— —	0 3.0	4.5 1.4	— —	11,200 19,000	1,300 760	14.5 14.5	—	—	1E4-G
Class A Amplifier	180 90	67.5 67.5	3.0 3.0	1.7 1.6	0.6 0.7	1,500,000 1,000,000	650 600	—	—	—	1E5-Gp



98C

- § Approximate.
- ▲ Without external shield.
- † Zero signal.
- ‡ Grids 3 and 5 are screen. Grid 4 is signal-input grid.
- # Conversion transconductance.
- \* Maximum.
- ♥ Grids 2 and 4 are screen. Grid 3 is signal-input grid.
- ✱ Screen supply voltage.
- ▣ Absolute maximum rating.
- ‡ Plate-to-plate.
- ◆ Per section.
- ◇ Design maximum rating.

- Ⓞ For both sections.
- \* Minimum.
- Ⓢ Heater warm-up time controlled for series-string service.
- ‡ Plate supply voltage.
- ‡ Input plate.
- The duration of the pulse voltage mu not exceed 15 percent of one scan cycle.
- 1— Section 1.
- 2— Section 2.
- 4— A resistor of 3 ohms must be put in series with heater.

Tube Type	Classification by Construction	Base Connections	Out-line Dwg	Fila-ment Volts	Fila-ment Amp	Max Plate Watts	Max Plate Volts	Max Screen Volts	Capacitance in Micromicrofarads		
									Input	Out-put	Grid-plate
<b>1E7-G</b> <b>1E7-GT</b>	Twin-Pentode Power Amplifier	8C	12-7 9-11 or 9-41	2.0 DC	0.24	1.5 ♣	135	135	Each Section Both Sections in Push-pull		
<b>1E8</b> ●	Pentagrid Converter	8CN ♥	3-5	1.25 DC	0.04	—	67.5	45	Osc $I_{g1} = 0.070$ ma $R_{g1} = 100,000$ ohms		
<b>1F4</b>	Power Amplifier Pentode	5K	14-1	2.0 DC	0.12	1.75	180	180	—	—	—
<b>1F5-G</b>	Power Amplifier Pentode	6X	12-7	2.0 DC	0.12	1.75	180	180	—	—	—
<b>1F6</b>	Duplex-Diode Sharp-Cutoff Pentode	6W	12-6	2.0 DC	0.06	0.4	180	67.5	4.0 ▲	9.0 ▲	0.007 ♣
<b>1F7-GH</b> <b>1F7-GV</b>	Duplex-Diode Sharp-Cutoff Pentode	7AD	12-8	2.0 DC	0.06	—	180	67.5	3.8	9.5	0.01 ♣
<b>1G4-GT</b>	Medium-Mu Triode	5S	9-11	1.4 DC	0.05	—	110	—	2.2 ▲	3.4 ▲	2.8 ▲
<b>1G5-G</b>	Power Amplifier Pentode	6X	12-7	2.0 DC	0.12	1.25	135	135	—	—	—
<b>1G6-GT</b>	Twin-Triode Power Amplifier	7AB	9-11 or 9-41	1.4 DC	0.1	—	110	—	—	—	—
<b>1H4-G</b> <b>1H4-GT</b>	Medium-Mu Triode	5S	12-7 9-11 or 9-41	2.0 DC	0.06	—	180	—	Single Tube 2 Tubes Push-pull		
<b>1H5-G</b> <b>1H5-GT</b>	Diode High-Mu Triode	5Z	9-28 9-18	1.4 DC	0.05	—	110	—	0.75	4.6	1.1
<b>1H6-G</b> <b>1H6-GT</b>	Duplex-Diode Medium-Mu Triode	7AA	12-7 9-11 or 9-41	2.0 DC	0.06	—	135	—	—	—	—
<b>1J5-G</b>	Power Amplifier Pentode	6X	14-3	2.0 DC	0.12	—	135	135	—	—	—
<b>1J6-G</b> <b>1J6-GT</b>	Twin-Triode Power Amplifier	7AB	12-7 9-16	2.0 DC	0.24	—	135	—	Both Sections in push-pull		
<b>1L4</b>	Sharp-Cutoff RF Pentode	6AR	5-2	1.4 DC	0.05	—	110	90	3.6 ▲	7.5 ▲	0.008 ▲ ♣
<b>1L6</b>	Pentagrid Converter	7DC ♣	5-2	1.4 DC	0.05	—	110	65	Osc $I_{g1} = 0.035$ ma $R_{g1} = 200,000$ ohms		
<b>1LA4</b>	Power Amplifier Pentode	5AD	9-30	1.4 DC	0.05	—	110	110	—	—	—
<b>1LA6</b>	Pentagrid Converter	7AK ♣	9-30	1.4 DC	0.05	—	110	65	Osc $I_{g1} = 0.035$ ma $R_{g1} = 200,000$ ohms		
<b>1LB4</b>	Power Amplifier Pentode	5AD	9-30	1.4 DC	0.05	—	110	110	—	—	—

Metal tubes are shown in bold-face type, miniature tubes in italics.

●Subminiature type.

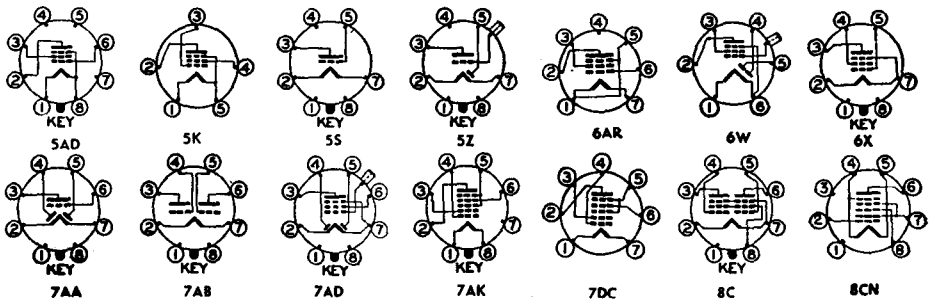



Service	Plate Volts	Screen Volts	Neg Grid Volts	Plate Milli-amperes	Screen Milli-amperes	R <sub>p</sub> , Ohms	G <sub>m</sub> , μmhos	μ Factor	Load for Rated Out-put, Ohms	Power Out-put, Watts	Tube Type
Class A Amplifier	135	135	4.5	7.5†	2.2†	260,000§	1,425	—	16,000	0.29	1E7-G 1E7-GT
	90	90	3.0	3.8†	1.1†	340,000§	1,150	—	20,000	0.11	
Class A Amplifier	135	135	7.5	7.0†	2.0†	—	—	—	24,000	0.575	
Converter	67.5	67.5 *	0	1.0	1.5	400,000§	150 #	R <sub>g2</sub> = 20,000 ohms			1E8 ⊙
Class A Amplifier	135	135	4.5	8†	2.4†	200,000§	1,700	—	16,000	0.31	1F4
	90	90	3.0	4	1.1	240,000§	1,400	—	—	—	
Class A Amplifier	135	135	4.5	8†	2.4†	200,000§	1,700	—	16,000	0.31	1F5-G
	90	90	3.0	4	1.1	240,000§	1,400	—	—	—	
Class A Amplifier	180	67.5	1.5	2.2	0.7	1,000,000	650	—	—	—	1F6
Class A Amplifier	180	67.5	1.5	2.2	0.7	1,000,000	650	—	—	—	1F7-GH 1F7-GV
Class A Amplifier	90	—	6	2.3	—	10,700	825	8.8	—	—	1G4-GT
Class A Amplifier	135	135	13.5	8.7†	2.5†	160,000	1,550	—	9,000	0.55	1G5-G
	90	90	6.0	8.5†	2.5†	133,000	1,500	—	8,500	0.25	
Class A Amplifier ♠	90	—	0	1.0	—	40,000§	825	33	—	—	1G6-GT
Class B Amplifier ⊕	90	—	0	2.0†	—	—	—	—	12,000	0.675	
Class A Amplifier Class B Amplifier	180	—	13.5	3.1	—	10,300	900	9.3	—	—	1H4-G 1H4-GT
	90	—	4.5	2.5	—	11,000	850	9.3	—	—	
Class A Amplifier	157.5	—	15.0	1.0†	—	Input Signal = .260 watt			8,000†	2.1	
Class A Amplifier	90	—	0	0.15	—	240,000	275	65	—	—	1H5-G 1H5-GT
Class A Amplifier	135	—	3.0	0.8	—	35,000§	575	20	—	—	1H6-G 1H6-GT
Class A Amplifier	135	135	16.5	7.0	2.0	105,300§	950	—	135,000	0.45	1J5-G
Class B Amplifier	135	—	0	5.0†	—	Input Signal = .170 watt§			10,000†	2.1‡	1J6-G 1J6-GT
Class A Amplifier	90	90	0	4.5	2.0	350,000	1,025	—	—	—	1L4
Converter	90	45	0	0.5	0.6	650,000§	300 #	E <sub>g2</sub> (Osc Plate) = 90 I <sub>g2</sub> = 1.2 ma			1L6
Class A Amplifier	90	90	4.5	4.0†	0.8†	300,000	850	—	25,000	0.115	1LA4
	85	85	4.5	3.5†	0.7†	300,000	800	—	25,000	0.100	
Converter	90	45	0	0.55	0.6	750,000§	250 #	E <sub>g2</sub> (Osc Plate) = 90 I <sub>g2</sub> = 1.2 ma			1LA6
Class A Amplifier	90	90	9.0	5.0†	1.0†	250,000§	925	—	12,000	0.20	1LB4

§ Approximate.  
 ▲ Without external shield.  
 † Zero signal.  
 ♦ Grids 3 and 5 are screen. Grid 4 is signal-input grid.  
 # Conversion transconductance.  
 ♠ Maximum.  
 ♥ Grids 2 and 4 are screen. Grid 3 is signal-input grid.  
 \* Screen supply voltage.  
 ⊕ Absolute maximum rating.  
 ‡ Plate-to-plate.  
 † Per section.  
 ⊙ Design maximum rating.

⊕ For both sections.  
 \* Minimum.  
 ¶ Heater warm-up time controlled for series-string service.  
 ‡ Plate supply voltage.  
 †† Input plate.  
 †— The duration of the pulse voltage must not exceed 15 percent of one scanning cycle.  
 1— Section 1.  
 2— Section 2.  
 †— A resistor of 3 ohms must be put in series with heater.

Tube Type	Classification by Construction	Base Con- nections	Out- line Dwg	Fila- ment Volts	Fila- ment Amp	Max Plate Watts	Max Plate Volts	Max Screen Volts	Capacitance in Micromicrofarads		
									Input	Out- put	Grid- plate
<b>1LB6</b>	Pentagrid Mixer	<b>8AX</b>	9-30	1.4 DC	0.05	—	90	67.5	$E_{g3}$ (Injection) = 10 v peak*		
<b>1LC5</b>	Sharp-Cutoff RF Pentode	<b>7AO</b>	9-30	1.4 DC	0.05	—	110	45	3.2	7.0	0.007 ♣
<b>1LC6</b>	Pentagrid Converter	<b>7AK</b> ♠	9-30	1.4 DC	0.05	—	110	45	Osc $I_{g1}$ = 0.035 ma $R_{g1}$ = 200,000 ohms		
<b>1LD5</b>	Diode Sharp-Cutoff Pentode	<b>6AX</b>	9-30	1.4 DC	0.05	—	90	45	3.2	6.0	0.18 ♣
<b>1LE3</b>	Medium-Mu Triode	<b>4AA</b>	9-30	1.4 DC	0.05	—	110	—	1.7	3.0	1.7
<b>1LF3</b>	Medium-Mu Triode	<b>4AA</b>	9-30	1.4 DC	0.05	—	110	—	1.7	3.0	1.7
<b>1LG5</b>	Semi-Remote Cutoff RF Pentode	<b>7AO</b>	9-30	1.4 DC	0.05	—	110	110	3.2	7.0	0.007 ♣
<b>1LH4</b>	Diode High-Mu Triode	<b>5AG</b>	9-30	1.4 DC	0.05	—	110	—	2.0	2.4	1.2
<b>1LN5</b>	Sharp-Cutoff RF Pentode	<b>7AO</b>	9-30	1.4 DC	0.05	—	110	110	3.0	8.0	0.007 ♣
<b>1M3</b> ⊙	Electron-Ray Indicator	<b>8DN</b>	3-2	1.4	0.025	0.0025	300	—	Max plate voltage = 90 v Min plate voltage = 45 v		
<b>1N5-G</b> <b>1N5-GT</b>	Sharp-Cutoff RF Pentode	<b>5Y</b>	9-28 9-18	1.4 DC	0.05	—	110	110	3.0 2.8	10.0 9.0	0.007 ♣ 0.007 ♣
<b>1N6-G</b> <b>1N6-GT</b>	Diode Power-Amplifier Pentode	<b>7AM</b>	T-X 9-11	1.4 DC	0.05	—	110	110	—	—	—
<b>1P5-G</b> <b>1P5-GT</b>	Remote-Cutoff RF Pentode	<b>5Y</b>	9-28 9-18	1.4 DC	0.05	—	110	110	3.0	10.0	0.007 ♣
<b>1Q5-GT</b>	Beam Power Amplifier	<b>6AF</b>	9-11 or 9-41	1.4 DC	0.1	—	110	110	—	—	—
<b>1Q6</b> ⊙	Diode Pentode	<b>8CO</b>	3-2	1.25 DC	0.04	—	100	100	1.8	4.2	0.085
<b>1R4</b>	High-Frequency Diode	<b>4AH</b>	9-30	1.4	0.15	—	Tube Voltage Drop: 8 v at 2 ma d-c				
<b>1R5</b>	Pentagrid Converter	<b>7AT</b> ♥	5-2	1.4 DC	0.05	—	90	67.5	Osc $I_{g1}$ = 0.25 ma $R_{g1}$ = 100,000 ohms Osc $I_{g1}$ = 0.15 ma $R_{g1}$ = 100,000 ohms		
<b>1S2</b> <b>1S2-A</b>	Half-Wave High- Voltage Rectifier	<b>9DT</b>	T-X	1.4	0.55	—	—	—	—	—	—

Metal tubes are shown in bold-face type, miniature tubes in italics. ⊙Subminiature type.

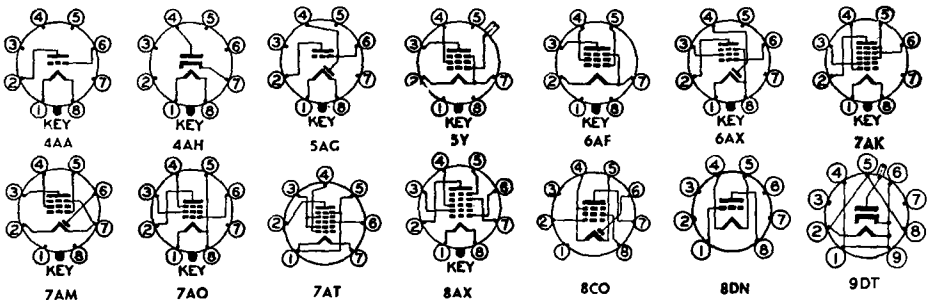

Service	Plate Volts	Screen Volts	Neg Grid Volts	Plate Milli-amperes	Screen Milli-amperes	R <sub>p</sub> , Ohms	G <sub>m</sub> , μmhos	μ Factor	Load for Rated Output, Ohms	Power Output, Watts	Tube Type
Mixer	90	67.5	0	0.4	2.2	2,000,000§	100 #	G <sub>2</sub> & 4 are screen; G <sub>1</sub> is signal grid			1LB6
Class A Amplifier	90	45	0	1.15	0.30	1,000,000*	775	—	—	—	1LC5
Converter	90	35	0	0.75	0.7	650,000§	275 #	E <sub>cs</sub> (Osc Plate) = 45 I <sub>cs</sub> = 1.4 ma			1LC6
Class A Amplifier	90	45	0	0.6	0.1	750,000	575	—	—	—	1LD5
Class A Amplifier	90 90	— —	0 3.0	4.5 1.4	—	11,200 19,000	1,300 760	14.5 14.5	—	—	1LE3
Class A Amplifier	90 90	— —	0 3.0	4.5 1.4	—	11,200 19,000	1,300 760	14.5 14.5	—	—	1LF3
Class A Amplifier	90 90	45 90	0 1.5	1.7 3.7	0.4 0.9	1,000,000* 500,000§	800 1,150	—	—	—	1LG5
Class A Amplifier	90	—	0	0.15	—	240,000	275	65	—	—	1LH4
Class A Amplifier	90	90	0	1.6	0.35	1,100,000§	800	—	—	—	1LN5
Tuning Indicator	Plate voltage = 250 v thru 1.8 meg; (E <sub>g</sub> = -34 v, illuminated length = 0") (E <sub>g</sub> = 0 v, I <sub>b</sub> = 105 μa, illuminated length = 3/8").									—	1M3 ⊙
Class A Amplifier	90	90	0	1.2	0.3	1,500,000§	750	—	—	—	1N5-G 1N5-GT
Class A Amplifier	90	90	4.5	3.4†	0.7†	300,000§	800	—	25,000	0.100	1N6-G 1N6-GT
Class A Amplifier	90	90	0	2.3	0.7	800,000§	750	—	—	—	1P5-G 1P5-GT
Class A Amplifier	90 85	90 85	4.5 5.0	9.5† 7.0†	1.3† 0.8†	90,000§ 70,000§	2,200 1,950	—	8,000 9,000	0.27 0.25	1Q5-GT
Class A Amplifier	67.5 30	67.5 30	0 0	1.6 0.33	0.40 0.09	400,000 500,000	600 330	—	—	—	1Q6 ⊙
Half-Wave Rectifier	Max d-c output current = 1.0 ma; max rms supply voltage = 117 volts									—	1R4
Converter	90	67.5	0	1.5	3.5	400,000§	280 #	—	—	—	1R5
Converter	45	45	0	0.7	2.1	500,000§	210 #	—	—	—	
TV Flyback Rectifier ‡	Max d-c output current = 0.8 ma; max inverse voltage (d-c component) = 22,000 volts; max peak current = 40 ma									—	1S2 1S2-A

§ Approximate.  
 ▲ Without external shield.  
 † Zero signal.  
 ♦ Grids 3 and 5 are screen. Grid 4 is signal-input grid.  
 # Conversion transconductance.  
 ♣ Maximum.  
 ♥ Grids 2 and 4 are screen. Grid 3 is signal-input grid.  
 ✱ Screen supply voltage.  
 ⊕ Absolute maximum rating.  
 ‡ Plate-to-plate.  
 ◆ Per section.  
 ⊙ Design maximum rating.

⊕ For both sections.  
 \* Minimum.  
 ¶ Heater warm-up time controlled for series-string service.  
 § Plate supply voltage.  
 || Input plate.  
 † The duration of the pulse voltage must not exceed 15 percent of one scanning cycle.  
 1—Section 1.  
 2—Section 2.  
 †—A resistor of 3 ohms must be put in series with heater.

Tube Type	Classification by Construction	Base Connections	Out-line Dwg	Fila-ment Volts	Fila-ment Amp	Max Plate Watts	Max Plate Volts	Max Screen Volts	Capacitance in Micromicrofarads		
									Input	Out-put	Grid-plate
<i>1S4</i>	Power Amplifier Pentode	7AV	5-2	1.4 DC	0.1	—	90	67.5	—	—	—
<i>1S5</i>	Diode Sharp-Cutoff Pentode	6AU	5-2	1.4 DC	0.05	—	90	90	—	—	—
<i>1S6</i> ●	Diode-Pentode	8DA	3-2	1.25 DC	0.04	—	100	100	—	—	—
<i>1SA6-GT</i>	RF Pentode	6BD	9-12	1.4 DC	0.05	—	90	67.5	5.2	8.6	0.01 ♣
<i>1SB6-GT</i>	Diode Pentode	6BE	9-11	1.4 DC	0.05	—	90	67.5	3.2	3.0	0.25
<i>1T2</i> ●	Half-Wave High-Voltage Rectifier	1T2	T-X	1.4	0.14	—	Tube Voltage Drop: 46 volts at 4 ma d-c				
<i>1T4</i>	Remote-Cutoff RF Pentode	6AR	5-2	1.4 DC	0.05	—	90	90	3.6	7.5	0.01 ♣
<i>1T5-GT</i>	Beam Power Amplifier	6X	9-11	1.4 DC	0.05	—	110	110	4.8	8.0	0.5
<i>1T6</i> ●	Diode-Pentode	8DA	3-5	1.25 DC	0.04	—	67.5	67.5	—	—	—
<i>1U4</i>	Sharp-Cutoff RF Pentode	6AR	5-2	1.4 DC	0.05	—	110	110	3.6	7.5	0.01 ♣
<i>1U6</i>	Diode Sharp-Cutoff Pentode	6BW	5-2	1.4 DC	0.05	—	90	90	—	—	—
<i>1U6</i>	Pentagrid Converter	7DC♠	5-2	1.4 DC	0.025	—	110	65	Osc $I_{g1} = 0.028$ ma $R_{g1} = 200,000$ ohms		
1-V	Half-Wave High-Vacuum Rectifier	4G	12-5	6.3	0.3	—	Tube Voltage Drop: 20 v at 90 ma d-c				
<i>1V2</i>	Half-Wave High-Voltage Rectifier	9U	6-2	0.625	0.3	—	Tube Voltage Drop: § 135 v at 7 ma d-c				
<i>1V5</i> ●	Power Amplifier Pentode	8CP	3-2	1.25 DC	0.04	—	100	100	—	—	—
<i>1V6</i> ●	Triode-Pentode Converter	1V6	2-3	1.25 DC	0.04	—	90	90	Osc $I_{g1} = 12$ $\mu$ a $R_{g1} = 1$ meg		
<i>1W4</i>	Power Amplifier Pentode	5BZ	5-2	1.4 DC	0.05	—	110	110	3.6	7.0	0.1
<i>1W5</i> ●	Sharp-Cutoff RF Pentode	8CP	3-2	1.25 DC	0.04	—	100	100	2.3	3.0	0.009 ♣
<i>1X2</i>	Half-Wave, High-Voltage Rectifier	9Y	6-7	1.25	0.2	—	Tube Voltage Drop: § 100 v at 7 ma d-c				
<i>1X2-A</i>	Half-Wave High-Voltage Rectifier	9Y	6-7	1.25	0.2	—	Tube Voltage Drop: § 100 v at 7 ma d-c				

Metal tubes are shown in bold-face type, *miniature tubes in italics.*

●Subminiature type.

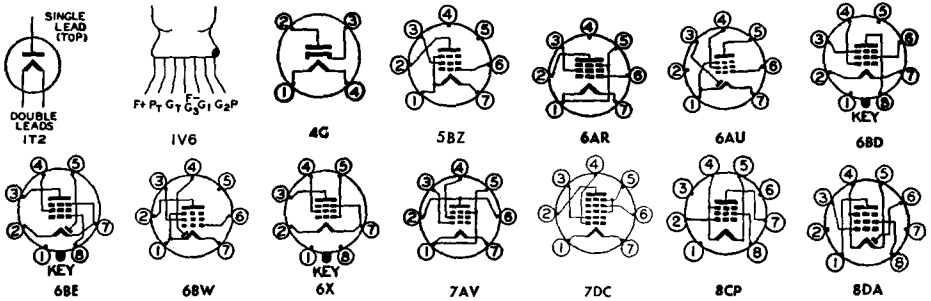

Service	Plate Volts	Screen Volts	Neg Grid Volts	Plate Milli-amperes	Screen Milli-amperes	R <sub>p</sub> Ohms	G <sub>m</sub> μmhos	μ Factor	Load for Rated Output, Ohms	Power Output, Watts	Tube Type
Class A Amplifier	90	67.5	7.0	7.4†	1.4†	100,000§	1,575	—	8,000	0.270	1S4
	67.5	67.5	7.0	7.2†	1.5†	100,000§	1,550	—	5,000	0.180	
	45	45.0	4.5	3.8†	0.8†	100,000§	1,250	—	8,000	0.065	
Class A Amplifier	67.5	67.5	0	1.6	0.4	600,000§	625	—	—	—	1S5
Class A Amplifier	67.5	67.5	0	1.6	0.4	400,000§	600	—	—	—	1S6 ●
	30	30	0	0.33	0.10	500,000§	330	—	—	—	
Class A Amplifier	90	67.5	0	2.45	0.68	800,000	970	—	—	—	1SA6-GT
Class A Amplifier	90	67.5	0	1.45	0.38	700,000	665	—	—	—	1SB6-GT
TV Flyback Rectifier <sub>2</sub>	Max d-c output current = 2 ma; max peak inverse voltage = 15,000 volts; max peak current = 12 ma										1T2 ●
Class A Amplifier	90	67.5	0	3.5	1.4	500,000§	900	—	—	—	1T4
	90	45	0	1.8	0.67	800,000§	750	—	—	—	
	67.5	67.5	0	3.4	1.5	250,000§	875	—	—	—	
	45	45	0	1.7	0.7	350,000§	700	—	—	—	
Class A Amplifier	90	90	6.0	6.5†	0.85†	250,000§	1,150	—	14,000	0.170	1T5-GT
Class A Amplifier	67.5	67.5	0	1.6	0.4	400,000§	600	—	—	—	1T6 ●
	30	30	0	0.33	0.10	500,000§	330	—	—	—	
Class A Amplifier	90	90	0	1.6	0.5	1,000,000§	900	—	—	—	1U4
Class A Amplifier	67.5	67.5	0	1.6	0.4	600,000§	625	—	—	—	1U5
Converter	90	45	0	0.6	0.6	500,000§	300 #	E <sub>c2</sub> (Osc Plate) = 90 I <sub>c2</sub> = 1.1 ma		—	1U6
Half-Wave Rectifier	Max d-c output current = 45 ma; max peak inverse voltage = 1000 volts; max rms supply voltage = 325 v; max peak current = 270 ma										1-V
TV Flyback Rectifier <sub>2</sub>	Max d-c output current = 0.5 ma; max inverse voltage (d-c component) = 6,600 volts; max peak current = 10 ma										1V2
Class A Amplifier	67.5	67.5	4.5	2.0	0.4	150,000	750	—	25,000	0.050	1V5 ●
	45	45	3.0	1.0	0.2	175,000	600	—	40,000	0.015	
	30	30	2.0	0.5	0.1	200,000	450	—	50,000	0.005	
Converter	45	45	R <sub>g</sub> = 5 meg	0.4	0.15	1,000,000§	200 #	E <sub>b</sub> (Triode Osc) = 45 I <sub>b</sub> (Triode) = 0.4 ma		—	1V6 ●
Class A Amplifier	90	90	9.0	5.0†	1.0†	250,000	925	—	12,000	0.20	1W4
	67.5	67.5	6.0	3.8†	0.8†	300,000	875	—	16,000	0.10	
Class A Amplifier	45	45	4.5	1.6†	0.3†	400,000	650	—	20,000	0.035	1W5 ●
	67.5	67.5	0	1.85	0.75	700,000§	735	—	—	—	
TV Flyback Rectifier <sub>2</sub>	Max d-c output current = 1.0 ma; max peak inverse voltage = 15,000 volts; max peak current = 10 ma										1X2
TV Flyback Rectifier <sub>2</sub>	Max d-c output current = 0.5 ma; max inverse voltage (d-c component) = 16,000 volts; max peak current = 45 ma										1X2-A

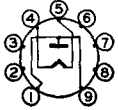

9U

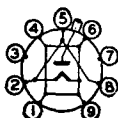

9Y

- § Approximate.
- ▲ Without external shield.
- † Zero signal.
- ◆ Grids 3 and 5 are screen. Grid 4 is signal-input grid.
- # Conversion transconductance.
- ◆ Maximum.
- ♥ Grids 2 and 4 are screen. Grid 3 is signal-input grid.
- ✱ Screen supply voltage.
- ⊠ Absolute maximum rating.
- † Plate-to-plate.
- ◆ Per section.
- ⊠ Design maximum rating.

- ⊠ For both sections.
- \* Minimum.
- ¶ Heater warm-up time controlled for series-string service.
- § Plate supply voltage.
- || Input plate.
- The duration of the pulse voltage must not exceed 15 percent of one scanning cycle.
- 1— Section 1.
- 2— Section 2.
- ⊠— A resistor of 3 ohms must be put in series with heater.

Tube Type	Classification by Construction	Base Connections	Outline Dwg	Filament Volts	Filament Amp	Max Plate Watts	Max Plate Volts	Max Screen Volts	Capacitance in Micromicrofarads		
									Input	Output	Grid-plate
<i>1X2-B</i>	Half-Wave High-Voltage Rectifier	9Y	6-7	1.25	0.2	—	Tube Voltage Drop: § 100 v at 7 ma d-c				
1Y2	Half-Wave High-Voltage Rectifier	4P	T-X	1.5	0.29	—	Tube Voltage Drop: 100 v at 8 ma d-c				
<i>1Z2</i>	Half-Wave High-Voltage Rectifier	7CB	T-X	1.5	0.3	—	Tube Voltage Drop: 50 v at 5.0 ma d-c				
2A3	Power-Amplifier Triode	4D	16-1	2.5	2.5	15	300	—	7.5▲	5.5▲	16.5▲
									2 tubes, push-pull		
2A4-G	Gas Triode	5S	12-7	2.5	2.5	—	Anode Voltage Drop = 15 volts				
2A5	Power Amplifier Pentode	6B	14-1	2.5	1.75	11	375	285	Pentode Connection		
							—	350	—	Triode Connection (G2 & P tied)	
2A6	Duplex-Diode High-Mu Triode	6G	12-6	2.5	0.8	—	250	—	1.7	3.8	1.7
2A7	Pentagrid Converter	7C♦	12-6	2.5	0.8	1.0	300	100	Osc I <sub>g1</sub> = 0.4 ma R <sub>g1</sub> = 50,000 ohms		
<i>2AF4</i> ¶ <i>2AF4-A</i> ¶	UHF Triode Oscillator	7DK	5-2 5-1	2.35	0.6	2.5♦	150♦	—	2.2	1.4	1.9
2B3	Half-Wave High-Voltage Rectifier	8HC	T-X	1.75	0.25	—	Tube Voltage Drop: § 100 v at 7 ma d-c				
2B7	Duplex-Diode Semi-Remote-Cutoff Pentode	7D	12-6	2.5	0.8	2.25	300	125	3.5▲	9.5▲	0.007♣
<i>2BN4</i> ¶	High Frequency Triode	7EG	5-2	2.3	0.6	2.2♦	275♦	—	3.2	1.4	1.2
2C21/1642	Medium-Mu Twin Triode	7BH	12-6	6.3	0.6	2.1♣	250	—	—	—	—
2C22	Medium-Mu Triode	4AM	T-X	6.3	0.3	3.3	300	—	2.2	0.7	3.6
2C50	Medium-Mu Twin Triode	8BD	T-X	12.6	0.3	3.85♣	—	—	—	—	—
<i>2C51</i>	High-Frequency Twin Triode	8CJ	6-1	6.3	0.3	1.5♣	300	—	2.3	1.3	1.3
2C52	High-Mu Twin Triode	8BD	9-12	12.6	0.3	1.0♣	300	—	2.3	0.75	2.7
<i>2D21</i>	Thyratron	7BN	5-2	6.3	0.6	—	—	Anode voltage drop = 8 volts			
2E5	Electron-Ray Indicator	6R	9-26 or 12-5	2.5	0.8	—	250§	Max target voltage = 250 Min target voltage = 125			

Metal tubes are shown in bold-face type, miniature tubes in italics.

♣Subminiature type.

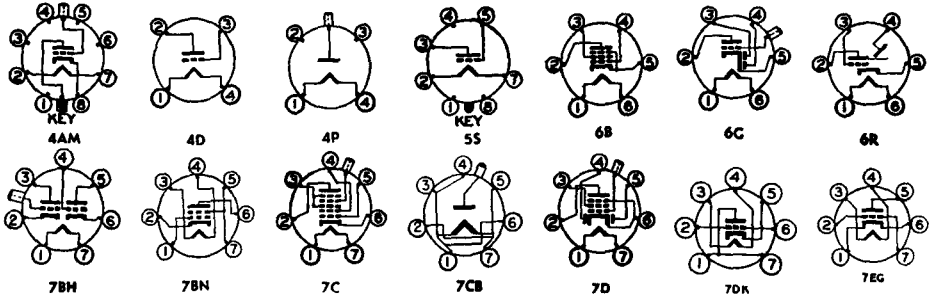

Service	Plate Volts	Screen Volts	Neg Grid Volts	Plate Milli-amperes	Screen Milli-amperes	R <sub>p</sub> , Ohms	G <sub>m</sub> , μmhos	μ Factor	Load for Rated Out-put, Ohms	Power Out-put, Watts	Tube Type
TV Flyback Rectifier <sub>1</sub>	Max d-c output current = 0.5 ma; max inverse voltage (d-c component) = 18,000 volts; max peak current = 45 ma										1X2-B
Half-Wave Rectifier	Max d-c output current = 2 ma; max peak inverse voltage = 50,000 volts; max peak current = 10 ma										1Y2
Half-Wave Rectifier	Max d-c output current = 2.0 ma; max peak inverse voltage = 20,000 volts; max peak current = 10 ma										1Z2
Class A Amplifier Class AB <sub>1</sub> Amplifier	250	—	45	60†	—	800	5,250	4.2	2,500	3.5	2A3
	300	—	62	80†	—	—	—	—	3,000†	15	
Relay Control	Max d-c anode current = 100 ma; max peak inverse voltage = 200 volts; max peak anode current = 1.25 amperes										2A4-G
Class A Amplifier Class A Amplifier	285	285	20.0	38†	7.0†	78,000§	2,500	—	7,000	4.8	2A5
	250	—	20.0	31	—	2,600	2,600	6.8	4,000	0.85	
Class A Amplifier	250	—	2.0	0.9	—	91,000	1,100	100	—	—	2A6
Converter	250	100	3.0	3.5	2.7	360,000§	550 #	E <sub>os</sub> (Osc Plate) = 250 thru 20,000 ohms I <sub>os</sub> = 4.0 ma		—	2A7
Class A Amplifier	80	—	R <sub>k</sub> = 150	17.5	—	2,100§	6,500	13.5	—	—	2AF4¶ 2AF4-A¶
TV Flyback Rectifier <sub>1</sub>	Max d-c output current ♦ = 0.5 ma; max inverse voltage (d-c component) ♦ = 22,000 volts; max peak current ♦ = 50 ma Socket terminals 3 and 5 may be used as tie point at filament potential.										2B3
Class A Amplifier	250	125	3.0	9.0	2.3	600,000§	1,125	—	—	—	2B7
	250	100	3.0	6.0	1.5	800,000	1,000	—	—	—	
Class A Amplifier	150	—	R <sub>k</sub> = 220	9.0	—	6,300§	6,800	43	—	—	2BN4¶
Class A Amplifier ♦	250	—	16.5	8.3	—	7,600	1,375	10.4	—	—	2C21/1642
Class A Amplifier	300	—	10.5	11	—	6,600	3,000	20	—	—	2C22
Class A Amplifier ♦	200	—	11	18	—	3,450	2,900	10	—	—	2C50
Class A Amplifier ♦	150	—	R <sub>k</sub> = 240	8.2	—	6,500	5,500	35	—	—	2C61
Class A Amplifier ♦	250	—	2.0	1.3	—	—	1,900	100	—	—	2C52
Controlled Rectifier	Max d-c cathode current ⊠ = 100 ma; max peak inverse voltage ⊠ = 1,300 volts; max peak cathode current ⊠ = 500 ma										2D21
Tuning Indicator	Plate voltage = 250 thru 1 meg, target voltage = 250 (E <sub>g</sub> = -8 volts, shadow = 0°) (E <sub>g</sub> = 0 volt, shadow = 90°, plate current = 0.24 ma, target current § = 4 ma)										2E5

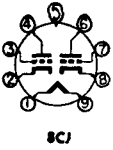
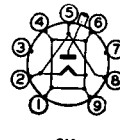
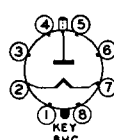
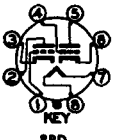

- ⊠ Screen supply voltage.
- ⊠ Absolute maximum rating.
- † Plate-to-plate.
- ♦ Per section.
- ⊠ Design maximum rating.
- ⊠ For both sections.
- \* Minimum.
- ¶ Heater warm-up time controlled for series-string service.
- ‡ Plate supply voltage.
- || Input plate.
- 3— The duration of the pulse voltage must not exceed 15 percent of one scanning cycle.
- 1— Section 1.
- 2— Section 2.
- 4— A resistor of 3 ohms must be put in series with heater.

§ Approximate.  
 ▲ Without external shield.  
 † Zero signal.  
 ♦ Grids 3 and 5 are screen. Grid 4 is signal-input grid.  
 # Conversion transconductance.  
 ◆ Maximum.  
 ♥ Grids 2 and 4 are screen. Grid 3 is signal-input grid.

Tube Type	Classification by Construction	Base Connections	Out-line Dwg	Filament Volts	Filament Amp	Max Plate Watts	Max Plate Volts	Max Screen Volts	Capacitance in Micromicrofarads		
									Input	Out-put	Grid-plate
<i>2E30</i>	Beam Power Amplifier	7CQ	5-3	{ 6.0 3.0 }	{ 0.65 1.30 }	10	250	—	9.6	14	0.18 ♣
<b>2E31</b> Ⓞ	Sharp-Cutoff RF Pentode	2E31	T-X	1.25 DC	0.05	—	45	45	4.2	4.0	0.018 ♣
<b>2E32</b> Ⓞ	Sharp-Cutoff RF Pentode	2E31	T-X	1.25 DC	0.05	—	45	45	4.2	4.0	0.018 ♣
<b>2E35</b> Ⓞ	Power Amplifier Pentode	2E35	T-X	1.25 DC	0.03	—	45	45	2.7	5.7	0.2 ♣
<b>2E36</b> Ⓞ	Power Amplifier Pentode	2E35	T-X	1.25 DC	0.03	—	45	45	2.7	5.7	0.2 ♣
<b>2E41</b> Ⓞ	Diode Pentode	2E41	T-X	1.25 DC	0.03	—	45	45	2.7	4.3	0.10
<b>2E42</b> Ⓞ	Diode Pentode	2E41	T-X	1.25 DC	0.03	—	45	45	2.7	4.3	0.10
<b>2G21</b> Ⓞ	Triode-Heptode Converter	2G21 ▼	T-X	1.25 DC	0.05	—	45	45	Osc I <sub>g1</sub> = 0.030 ma R <sub>g1</sub> = 50,000 ohms		
<b>2G22</b> Ⓞ	Triode-Heptode Converter	2G21 ▼	T-X	1.25 DC	0.05	—	45	45	Osc I <sub>g1</sub> = 0.030 ma R <sub>g1</sub> = 50,000 ohms		
<i>2T4</i> ¶	UHF Triode Oscillator	7DK	5-1	2.35	0.6	3.5	200	—	2.6 ▲	0.4 ▲	1.7 ▲
<b>2V2</b>	Half-Wave High-Voltage Rectifier	8FV	T-X	{ 2.5 1.25 }	{ 0.2 0.4 }	—	Tube Voltage Drop: 150 v at 7.0 ma d-c				
<b>2V3-G</b>	Half-Wave High-Voltage Rectifier	4Y	12-8	2.5	5	—	—	—	—	—	—
<b>2W3</b> <b>2W3-GT</b>	Half-Wave High-Vacuum Rectifier	4X	8-6 9-12	2.5	1.5	—	—	—	—	—	—
<b>2X2-A</b>	Half-Wave High-Voltage Rectifier	4AB	12-6	2.5	1.75	—	—	—	—	—	—
<b>3A2</b>	Half-Wave High-Voltage Rectifier	9DT	6-7	3.15	0.22	—	—	—	—	—	—
<b>3A3</b>	Half-Wave High-Voltage Rectifier	4AC	T-X	3.15	0.22	—	—	—	—	—	—
<b>3A4</b>	Power Amplifier Pentode	7BB	5-2	{ 2.8 1.4 DC }	{ 0.1 0.2 }	2.3	150	90	4.8	4.2	0.20 ♣
<b>3A5</b>	High-Frequency Twin Triode	7BC	5-2	{ 2.8 1.4 DC }	{ 0.11 0.22 }	0.5 ♣	135	—	0.9	1.0	3.2
<b>3A8-GT</b>	Diode-Triode Sharp-Cutoff RF Pentode	8AS	9-17	{ 2.8 1.4 DC }	{ 0.05 0.1 }	— —	110 110	— 110	Triode Section Pentode Section		
<i>3AF4-A</i> ¶	UHF Triode Oscillator	7DK	5-1	3.2	0.45	2.5 ♦	150 ♦	—	2.2	1.4	1.9

Metal tubes are shown in bold-face type, miniature tubes in italics. ⓄSubminiature type.

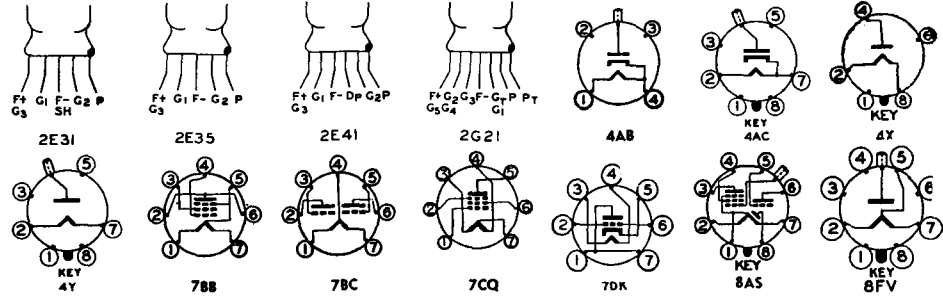



Service	Plate Volts	Screen Volts	Neg Grid Volts	Plate Milli-am-peres	Screen Milli-am-peres	R <sub>p</sub> Ohms	G <sub>m</sub> μmhos	μ Factor	Load for Rated Out-put, Ohms	Power Out-put, Watts	Tube Type
Class A Amplifier	250	250	20	40†	3.3†	63,000	3,700	—	4,500	4.5	2E30
Class A Amplifier	22.5	22.5	R <sub>g</sub> = 5 meg	0.4	0.3	350,000	500	—	—	—	2E31 ⊙
Class A Amplifier	22.5	22.5	R <sub>g</sub> = 5 meg	0.4	0.3	350,000	500	—	—	—	2E32 ⊙
Class A Amplifier	45	45	1.25	0.45	0.11	250,000	500	—	100,000	0.006	2E35 ⊙
Class A Amplifier	45	45	1.25	0.45	0.11	250,000	500	—	100,000	0.006	2E36 ⊙
Class A Amplifier	22.5	22.5	R <sub>g</sub> = 5 meg	0.35	0.12	250,000	375	—	—	—	2E41 ⊙
Class A Amplifier	22.5	22.5	R <sub>g</sub> = 5 meg	0.35	0.12	250,000	375	—	—	—	2E42 ⊙
Converter	22.5	22.5	0	0.2	0.3	500,000§	60 #	E <sub>b</sub> (Triode Osc) = 22.5 I <sub>b</sub> (Triode) = 1.0 ma			2G21 ⊙
Converter	22.5	22.5	0	0.2	0.3	500,000§	60 #	E <sub>b</sub> (Triode Osc) = 22.5 I <sub>b</sub> (Triode) = 1.0 ma			2G22 ⊙
Class A Amplifier	80	—	R <sub>k</sub> = 150	18	—	1,860§	7,000	13	—	—	2T4 ¶
TV Flyback Rectifier,	Max d-c output current = 1.0 ma; max inverse voltage (d-c component) = 21,000 volts; max peak current = 80 ma										2V2
Half-Wave Rectifier	Max d-c output current = 2 ma; max peak inverse voltage = 16,500 volts; max peak current = 12 ma										2V3-G
Half-Wave Rectifier	Max d-c output current = 55 ma; max rms supply voltage = 350 volts										2W3 2W3-GT
Half-Wave Rectifier	Max d-c output current = 7.5 ma; max peak inverse voltage = 12,500 volts; rms supply voltage = 5,500 volts; max peak current = 60 ma										2X2-A
TV Flyback Rectifier,	Max d-c output current = 1.5 ma; max peak inverse voltage = 18,000 volts; max peak current = 80 ma										3A2
TV Flyback Rectifier,	Max d-c output current = 1.5 ma; max peak inverse voltage = 30,000 volts; max peak current = 80 ma										3A3
Class A Amplifier	150	90	8.4	13.3†	2.2†	100,000	1,900	—	8,000	0.7	3A4
Class A Amplifier ♦	90	—	2.5	3.7	—	8,300	1,800	15	—	—	3A5
Class A Amplifier	90	—	0	0.2	—	200,000	275	—	—	—	3A8-GT
Class A Amplifier	90	90	0	1.5	0.5	800,000	750	—	—	—	
Class A Amplifier	80	—	R <sub>k</sub> = 150	17.5	—	2,100§	6,500	13.5	—	—	3AF4-A ¶



9DT

- § Approximate.
- ▲ Without external shield.
- † Zero signal.
- ♦ Grids 3 and 5 are screen. Grid 4 is signal-input grid.
- # Conversion transconductance.
- ◆ Maximum.
- ♥ Grids 2 and 4 are screen. Grid 3 is signal-input grid.
- \* Screen supply voltage.
- ⊙ Absolute maximum rating.
- † Plate-to-plate.
- ◆ Per section.
- ⊙ Design maximum rating.

- ⊙ For both sections.
- \* Minimum.
- ¶ Heater warm-up time controlled for series-string service.
- § Plate supply voltage.
- || Input plate.
- 3— The duration of the pulse voltage must not exceed 15 percent of one scanning cycle.
- 1— Section 1.
- 2— Section 2.
- 4— A resistor of 3 ohms must be put in series with heater.

Tube Type	Classification by Construction	Base Connections	Out-line Dwg	Filament Volts	Filament Amp	Max Plate Watts	Max Plate Volts	Max Screen Volts	Capacitance in Micromicrofarads		
									Input	Output	Grid-plate
<i>3AL6</i> ¶	Twin Diode	6BT	5-1	3.15	0.6	—	Tube Voltage Drop: ♦ 10 v at 60 ma d-c				
<i>3AU6</i> ¶	Sharp-Cutoff RF Pentode	7BK	5-2	3.15	0.6	3.0	300	150	Pentode Connection		
						3.2	250	—	Triode Connection (G <sub>2</sub> , G <sub>3</sub> , & P tied)		
<i>3AV6</i> ¶	Duplex-Diode High-Mu Triode	7BT	5-2	3.15	0.6	0.5	300	—	2.2	1.2	2.0
3B2	Half-Wave High-Vacuum Rectifier	8GH	T-X	3.15	0.22	—	Tube Voltage Drop: § 135 v at 7 ma d-c				
<i>3B4</i>	Beam Power Amplifier	7CY	5-2	1.25 2.50 DC	0.33 0.165	3.0 □	150	135	4.6 ▲	7.6 ▲	0.16 ▲ ♣
3B5-GT	Beam Power Amplifier	7AQ	9-12	1.4 2.8 DC	0.1 0.05	—	67.5	67.5	Parallel Filaments		
						—	67.5	67.5	Series Filaments		
3B7	High-Frequency Twin Triode	7BE	9-30	1.4 2.8 DC	0.22 0.11	2.7 ♣	180	—	Both Sections in Push-pull		
<i>3BA6</i> ¶	Remote-Cutoff RF Pentode	7BK	5-2	3.15	0.6	3.0	300	150	5.5	5.5	0.0035 ♣
<i>3BC6</i> ¶	Sharp-Cutoff RF Pentode	7BD	5-2	3.15	0.6	2.0	300	150	Pentode Connection		
						2.5	300	—	Triode Connection (G <sub>2</sub> & P tied)		
<i>3BE6</i> ¶	Pentagrid Converter	7CH ▼	5-2	3.15	0.6	1.0	300	100	Osc I <sub>g1</sub> = 0.5 ma R <sub>g1</sub> = 20,000 ohms		
<i>3BN4</i> ¶	High-Frequency Triode	7EG	5-2	2.8	0.45	2.2 ♦	275 ♦	—	3.2	1.4	1.2
<i>3BN6</i> ¶	Gated-Beam Discriminator	7DF	5-3	3.15	0.6	—	300 §	100	E <sub>c1</sub> = 1.25 volts RMS*		
<i>3BU8</i> ¶	Twin Pentode	9FG	6-3	3.15	0.6	1.1 ♦ ♣	300 ♦	150 ♦	—	—	—
<i>3BY6</i> ¶	Dual-Control Heptode	7CH	5-2	3.15	0.6	2.0	300	150	—	—	—

Metal tubes are shown in bold-face type, miniature tubes in italics.      ¶ Subminiature type.

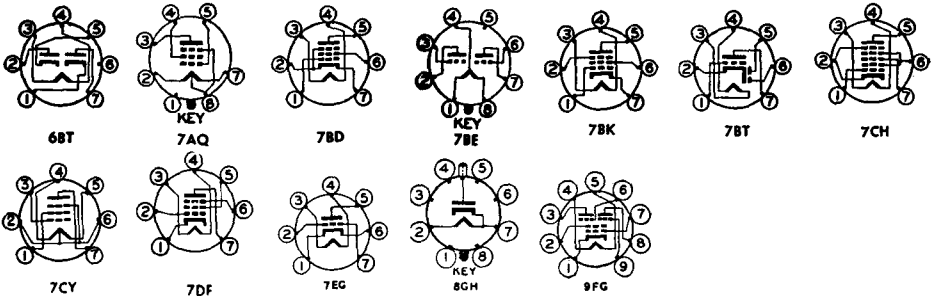

Service	Plate Volts	Screen Volts	Neg Grid Volts	Plate Milli-am-peres	Screen Milli-am-peres	R <sub>p</sub> Ohms	G <sub>m</sub> μmhos	μ Factor	Load for Rated Out-put, Ohms	Power Out-put, Watts	Tube Type
Half-Wave Rectifier	Max d-c output current per plate = 9 ma; max peak inverse voltage = 330 volts; max rms supply voltage per plate = 117 volts; max peak current per plate = 54 ma									3AL6¶	
Class A Amplifier	250	150	R <sub>k</sub> = 10.6	4.3	1,000,000‡	5,200	—	—	—	—	3AU6¶
	100	100	R <sub>k</sub> = 68 R <sub>k</sub> = 150	5.0	2.1	500,000‡	3,900	—	—	—	
Class A Amplifier	250	—	R <sub>k</sub> = 330	12.2	—	4,800	36	—	—	—	3AV6¶
Class A Amplifier	250	—	2.0	1.2	—	62,500‡	1,600	100	—	—	3AV6¶
	100	—	1.0	0.5	—	80,000‡	1,250	100	—	—	
TV Flyback Rectifier	Max d-c output current = 1.1 ma; max inverse voltage (d-c component) = 25,000 volts; max peak current = 80 ma									3B2	
Class C Amplifier	150	135	38	25	6.2	Input Signal = 0.07 watt		—	1.25	—	3B4
Class A Amplifier	67.5	67.5	7.0	8.0†	0.6†	100,000	1,650	—	5,000	0.2	3B5-GT
	67.5	67.5	7.0	6.7†	0.5†	100,000	1,500	—	5,000	0.18	
Class AB <sub>2</sub> Amplifier	135	—	0	18.2†	—	—	1,900 ♣	20♣	16,000 ‡	1.5	3B7
Class A Amplifier	250	100	R <sub>k</sub> = 11	4.2	1,000,000‡	4,400	—	—	—	—	3BA6¶
	100	100	R <sub>k</sub> = 68 R <sub>k</sub> = 10.8	4.4	250,000‡	4,300	—	—	—	—	
Class A Amplifier	250	150	R <sub>k</sub> = 7.5	2.1	800,000‡	5,700	—	—	—	—	3BC5¶
	125	125	R <sub>k</sub> = 180 R <sub>k</sub> = 100	8.0	2.4	500,000‡	6,100	—	—	—	
	100	100	R <sub>k</sub> = 180 R <sub>k</sub> = 100	4.7	1.4	600,000‡	4,900	—	—	—	
Class A Amplifier	250	—	R <sub>k</sub> = 820 R <sub>k</sub> = 330	6.0	—	9,000‡	4,400	40	—	—	3BC5¶
	180	—	R <sub>k</sub> = 820 R <sub>k</sub> = 330	8.0	—	6,000‡	6,000	42	—	—	
Converter	250	100	1.5	2.9	6.8	1,000,000‡	475 #	—	—	—	3BE6¶
	100	100	1.5	2.6	7.0	400,000‡	455 #	—	—	—	
Class A Amplifier	150	—	R <sub>k</sub> = 220	9.0	—	6,300‡	6,800	43	—	—	3BN4¶
FM Limiter-Discriminator	285‡	100	R <sub>k</sub> = 200 to 400	0.49	9.8	—	—	—	330,000	—	3BN6¶
Sync Separator and AGC Keyer	100	67.5	1c <sub>1</sub> = 0.1 ma	2.2	5.0‡	—	—	—	E <sub>c3</sub> = 0 volts	—	3BU8¶
	100	67.5	0	—	—	—	1,500	—	E <sub>c3</sub> = 0 volts	—	
(Characteristics given are for each section separately with plate and grid number 3 of opposite section grounded)											
Gated Amplifier	250	100	2.5	6.5	9	—	1,900	E <sub>c3</sub> = -2.5 volts	—	—	3BY6¶
	10	25	0	1.4	3.5	—	—	E <sub>c3</sub> = 0 volts	—	—	

- ‡ Approximate.
- ♣ Without external shield.
- † Zero signal.
- ‡ Grids 3 and 5 are screen. Grid 4 is signal-input grid.
- # Conversion transconductance.
- ♣ Maximum.
- ♣ Grids 2 and 4 are screen. Grid 3 is signal-input grid.
- ♣ Screen supply voltage.
- ♣ Absolute maximum rating.
- ‡ Plate-to-plate.
- ♣ Per section.
- ♣ Design maximum rating.
- ⊕ For both sections.
- \* Minimum.
- ¶ Heater warm-up time controlled for series-string service.
- ‡ Plate supply voltage.
- || Input plate.
- ‡—The duration of the pulse voltage must not exceed 15 percent of one scanning cycle.
- 1—Section 1.
- ‡—Section 2.
- ‡—A resistor of 3 ohms must be put in series with heater.

Tube Type	Classification by Construction	Base Connections	Out-line Dwg	Filament Volts	Filament Amp	Max Plate Watts	Max Plate Volts	Max Screen Volts	Capacitance in Micromicrofarads		
									Input	Output	Grid-plate
<i>3BZ6</i> ¶	Semi-Remote-Cutoff RF Pentode	7CM	5-2	3.15	0.6	2.3◆	330◆	165◆	7.0	3.0	0015♣
3C2	Half-Wave High-Voltage Rectifier	8FV	T-X	{3.15 1.58}	{0.21 0.42}	—	Tube Voltage Drop:§ 62 v at 7 ma d-c				
<i>3C4</i>	Power Amplifier Pentode	6BX	T-X	1.4 DC	0.05	0.6	90	90	Parallel Filaments		
<i>3C5-GT</i>	Power Amplifier Pentode	7AQ	9-12	1.4	0.1	—	110	110	Parallel Filaments		
				2.8 DC	0.05	—	110	110	Series Filaments		
3C6	Medium-Mu Twin Triode	7BW	9-30	1.4	0.1	—	110	—	Section 1 { Parallel Filaments } Section 2 { Filaments } Section 1 { Series Filaments } Section 2 { Filaments }		
				2.8 DC	0.05	—	110	—			
<i>3CB6</i> ¶	Sharp-Cutoff RF Pentode	7CM	5-2	3.15	0.6	2.3◆	330◆	165◆	6.5	3.0	0.015♣
<i>3CE5</i> ¶	Sharp-Cutoff RF Pentode	7BD	5-2	3.15	0.6	2.0	300	150	6.5▲	1.9▲	0.03♣▲
<i>3CF6</i> ¶	Sharp-Cutoff RF Pentode	7CM	5-2	3.15	0.6	2.3◆	330◆	165◆	6.5	3.0	0.015♣
<i>3CS6</i> ¶	Dual-Control Heptode	7CH	5-2	3.15	0.6	1.0	300	100	5.5	7.5	0.07♣
3D6	Beam Power Amplifier	6BA	9-30	1.4 DC	0.22	4.5	180	135	7.5	6.5	0.30
<i>3DT6</i> ¶	Sharp-Cutoff Pentode	7EN	5-2	3.15	0.6	1.5	300	150	—	—	—
									I <sub>c1</sub> = 0.6 ma		
<i>3E5</i>	Beam Power Amplifier	6BX	5-2	1.4	0.05	—	135	90	Parallel Filaments		
				2.8 DC	0.025	—	135	90	Series Filaments		
<i>3E6</i>	Sharp-Cutoff RF Pentode	7CJ	9-30	2.8	0.05	—	110	110	Series Filaments		
				1.4 DC	0.1	—	110	110	Parallel Filaments		
3LE4	Power Amplifier Pentode	6BA	9-30	1.4	0.1	—	110	110	Parallel Filaments		
				2.8 DC	0.05	—	110	110	Series Filaments		
3LF4	Beam Power Amplifier	6BB	9-30	2.8	0.05	—	110	110	Series Filaments		
				1.4 DC	0.1	—	110	110	Parallel Filaments		

Metal tubes shown in bold-face type, miniature tubes in italics.

◎Subminiature type.

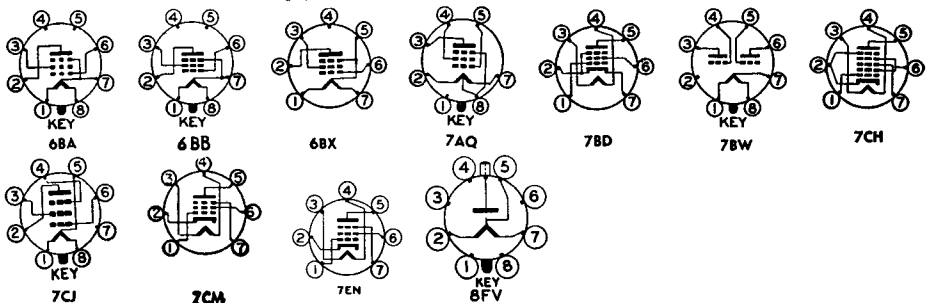

Service	Plate Volts	Screen Volts	Neg Grid Volts	Plate Milli-amperes	Screen Milli-amperes	R <sub>p</sub> , Ohms	G <sub>m</sub> , $\mu$ mhos	$\mu$ Factor	Load for Rated Output, Ohms	Power Output, Watts	Tube Type
Class A Amplifier	125	125	R <sub>k</sub> = 56	14	3.6	260,000§	8,000	—	—	—	3BZ6¶
	125	125	4.5	—	—	—	700	—	—	—	
TV Flyback Rectifiers	Max d-c output current ♦ = 1.1 ma; max inverse voltage (d-c component) ♦ = 28,000 volts; max peak current ♦ = 80 ma Socket terminals 1 and 3 may be used as tie points at filament potential										3C2
Class A Amplifier	85	85	5.2	5.0	1.1	125,000	1,350	—	13,000	0.2	3C4
Class A Amplifier Class A Amplifier	90	90	9.0	6.0†	1.4†	—	1,550	—	8,000	0.24	3C5-GT
	90	90	9.0	6.0†	1.4†	—	1,450	—	10,000	0.26	
Class A Amplifier Class A Amplifier Class A Amplifier	90	—	0	4.5	—	11,200	1,300	14.5	—	—	3C6
	90	—	0	4.5	—	11,200	1,300	14.5	—	—	
	90	—	0	4.5	—	11,200	1,300	14.5	—	—	
	90	—	0	3.2	—	12,800	1,100	14.1	—	—	
Class A Amplifier	125	125	R <sub>k</sub> = 56	13	3.7	280,000§	8,000	—	—	—	3CB6¶
	125	125	3.0	2.8	—	—	—	—	—	—	
Class A Amplifier	125	125	1.0	11	2.8	300,000§	7,600	—	—	—	3CE5¶
Class A Amplifier	125	125	R = 56	12.5	3.7	300,000§	7,800	—	—	—	3CF6¶
	125	125	3.0	2.2	—	—	—	—	—	—	
Gated Amplifier	100	30	1.0	1.0	1.3	1,000,000§	1,100	E <sub>cs</sub> = 0 volts	—	—	3CS6¶
	100	30	0	0.8	5.5	700,000§	—	E <sub>cs</sub> = -1.0 volts	—	—	
	10	30	0	2.0	4.5	—	—	E <sub>cs</sub> = 0 volts	—	—	
Class A Amplifier	150	90	4.5	9.8†	1.0†	—	2,400	—	14,000	0.60	3D6
Class A Amplifier FM Limiter-Discriminator	150	100	R <sub>k</sub> = 560	1.1	2.1	150,000§	800	—	E <sub>cs</sub> = 0 volt	—	3DT6¶
	250‡	100	R <sub>k</sub> = 560	0.22	5.5	E <sub>cs</sub> = -6.0 volt	—	—	270,000	—	
Class A Amplifier Class A Amplifier Class A Amplifier	90	90	7.0	8.0	1.6	100,000	1,550	—	8,000	0.250	3E5
	67.5	67.5	5.0	5.5	1.1	120,000	1,400	—	8,000	0.125	
	90	90	7.0	6.8	1.4	120,000	1,450	—	9,000	0.225	
	67.5	67.5	5.0	4.4	0.9	130,000	1,300	—	11,000	0.115	
Class A Amplifier Class A Amplifier	90	90	R <sub>g</sub> = 2 meg	2.9	1.2	325,000§	1,700	—	—	—	3E6
	90	90	R <sub>g</sub> = 2 meg	4.2	1.7	250,000§	2,000	—	—	—	
Class A Amplifier Class A Amplifier	90	90	9.0	10†	2.0†	100,000§	1,700	—	6,000	0.325	3LE4
	90	90	9.0	8.8†	1.8†	110,000§	1,600	—	6,000	0.300	
Class A Amplifier Class A Amplifier Class A Amplifier	110	110	6.6	8.5	1.1	110,000§	2,000	—	8,000	0.33	3LF4
	90	90	4.5	8.0	1.0	80,000§	2,000	—	8,000	0.23	
	110	110	6.6	10	1.4	100,000§	2,200	—	8,000	0.40	
	90	90	4.5	9.5	1.3	90,000§	2,200	—	8,000	0.27	

§ Approximate.

▲ Without external shield.

† Zero signal.

♦ Grids 3 and 5 are screen. Grid 4 is signal-input grid.

# Conversion transconductance.

◆ Maximum.

▼ Grids 2 and 4 are screen. Grid 3 is signal-input grid.

✱ Screen supply voltage.

▣ Absolute maximum rating.

‡ Plate-to-plate.

◆ Per section.

◇ Design maximum rating.

¶ For both sections.

\* Minimum.

¶ Heater warm-up time controlled for series-string service.

‡ Plate supply voltage.

|| Input plate.

— The duration of the pulse voltage must not exceed 15 percent of one scanning cycle.

1—Section 1.

2—Section 2.

1—A resistor of 3 ohms must be put in series with heater.

Tube Type	Classification by Construction	Base Connections	Out-line Dwg	Filament Volts	Filament Amp	Max Plate Watts	Max Plate Volts	Max Screen Volts	Capacitance in Micromicrofarads		
									Input	Output	Grid-plate
<b>3Q4</b>	Power Amplifier Pentode	7BA	5-2	1.4	0.1	—	90	90	Parallel Filaments		
				2.8 DC	0.05	—	90	90	Series Filaments		
<b>3O5-GT</b>	Beam Power Amplifier	7AP	9-11 or 9-41	1.4	0.1	—	110	110	Parallel Filaments		
				2.8 DC	0.05	—	110	110	Series Filaments		
<b>3S4</b>	Power Amplifier Pentode	7BA	5-2	1.4	0.1	—	90	67.5	Parallel Filaments		
				2.8 DC	0.05	—	90	67.5	Series Filaments		
<b>3V4</b>	Power Amplifier Pentode	6BX	5-2	1.4	0.1	—	90	90	Parallel Filaments		
				2.8 DC	0.05	—	90	90	Series Filaments		
<b>3W4</b>	Power Amplifier Pentode	7BA	5-2	1.4 2.8 DC	0.05 0.025	—	90	90	—	—	—
<b>4A6-G</b>	Twin Triode Power Amplifier	8L	12-7	4.0 2.0 DC	0.06 0.12	—	90	—	—		
<b>4BC6</b> ¶	Sharp-Cutoff RF Pentode	7BD	5-2	4.2	0.45	2.0	300	150	Pentode Connection		
						2.5	300	—	Triode Connection (G <sub>2</sub> and P tied)		
<b>4BC8</b> ¶	High-Frequency Twin Triode	9AJ	6-2	4.2	0.6	2.0♣	250	—	2.5	1.3	1.4
<b>4BN6</b> ¶	Gated-Beam Discriminator	7DF	5-3	4.2	0.45	—	300♣	100	E <sub>c1</sub> = 1.25 volts RMS*		
<b>4BQ7-A</b> ¶	High-Frequency Twin Triode	9AJ	6-2	4.2	0.6	2.0♣	250	—	2.6 <sub>1</sub>	1.2 <sub>1</sub>	1.2
<b>4BS8</b> ¶	Medium- $\mu$ Twin Triode	9AJ	6-2	4.5	0.6	2.0♣	150	—	2.6 <sub>1</sub>	1.2 <sub>1</sub>	1.15
<b>4BU8</b> ¶	Twin Pentode	9FG	6-3	4.2	0.45	1.1♦	300♦	150♦	—	—	—
<b>4BX8</b> ¶	High-Frequency Twin Triode	9AJ	6-2	4.5	0.6	2.0♦♣	150♦	—	2.4 <sub>2</sub>	1.25 <sub>2</sub>	1.4
<b>4BZ7</b> ¶	High-Frequency Twin Triode	9AJ	6-2	4.2	0.6	2.0♣	250	—	2.6 <sub>1</sub>	1.2 <sub>1</sub>	1.2
<b>4BZ8</b> ¶	High-Frequency Twin Triode	9AJ	6-2	4.2	0.6	2.2♣	250	—	—	—	—

Metal tubes are shown in bold-face type, miniature tubes in italics.

♣Subminiature type.

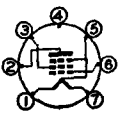

**6BX**

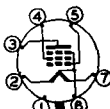

**7AP**

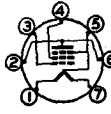

**7BA**

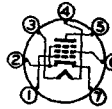

**7BD**

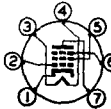

**7DF**

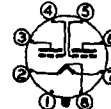

**8L**



**9AJ**

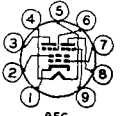

**9FG**

Service	Plate Volts	Screen Volts	Neg Grid Volts	Plate Milli-amperes	Screen Milli-amperes	R <sub>p</sub> , Ohms	G <sub>m</sub> , μmhos	μ Factor	Load for Rated Output, Ohms	Power Output, Watts	Tube Type
Class A Amplifier	90	90	4.5	9.5†	2.1†	100,000§	2,150	—	10,000	0.27	3Q4
Class A Amplifier	90	90	4.5	7.7†	1.7†	120,000§	2,000	—	10,000	0.24	
Class A Amplifier	110	110	6.6	10†	1.4†	100,000§	2,200	—	8,000	0.40	3Q5-GT
	90	90	4.5	9.5†	1.3†	90,000§	2,200	—	8,000	0.27	
Class A Amplifier	110	110	6.6	8.5†	1.1†	110,000§	2,000	—	8,000	0.33	3S4
	90	90	4.5	8.0†	1.0†	80,000§	2,000	—	8,000	0.23	
Class A Amplifier	90	67.5	7.0	7.4†	1.4†	100,000§	1,575	—	8,000	0.270	3V4
	67.5	67.5	7.0	7.2†	1.5†	100,000§	1,550	—	5,000	0.180	
	90	67.5	7.0	6.1†	1.1†	100,000§	1,425	—	8,000	0.235	
	67.5	67.5	7.0	6.0†	1.2†	100,000§	1,400	—	5,000	0.160	
Class A Amplifier	90	90	4.5	9.5†	2.1†	100,000§	2,150	—	10,000	0.27	3W4
	85	85	5.0	6.9†	1.5†	120,000§	1,975	—	10,000	0.25	
	90	90	4.5	7.7†	1.7†	120,000§	2,000	—	10,000	0.24	
Class A Amplifier	85	85	5.2	6.8†	1.4†	150,000§	1,700	—	11,000	0.25	3W4
Class A Amplifier ♦	90	—	1.5	1.2	—	28,000	900	25	—	—	4A6-G
Class A Amplifier	250	150	R <sub>k</sub> = 180	7.5	2.1	800,000§	5,700	—	—	—	4BC5¶
	125	125	R <sub>k</sub> = 100	8.0	2.4	500,000§	6,100	—	—	—	
	100	100	R <sub>k</sub> = 100	4.7	1.4	600,000§	4,900	—	—	—	
Class A Amplifier	250	—	R <sub>k</sub> = 180	6.0	—	9,000§	4,400	40	—	—	4BC8¶
	180	—	R <sub>k</sub> = 820	8.0	—	6,000§	6,000	42	—	—	
Class A Amplifier ♦	150	—	R <sub>k</sub> = 220	10	—	5,650§	6,200	35	—	—	4BC8¶
FM Limiter-Discriminator	285§	100	R <sub>k</sub> = 200 to 400	0.49	9.8	—	—	—	330,000	—	4BN6¶
Class A Amplifier ♦	150	—	R <sub>k</sub> = 220	9.0	—	5,900§	6,400	38	—	—	4BQ7-A¶
Class A Amplifier ♦	150	—	R <sub>k</sub> = 220	10	—	5,000	7,200	36	—	—	4BS8¶
Sync Separator and AGC Keyer (Characteristics given are opposite section grounded)	100	67.5	I <sub>s1</sub> = 0.1 ma	2.2	5.0§	—	—	—	E <sub>c3</sub> = 0 volts	—	4BU8¶
	100	67.5	0	—	—	—	1,500	—	E <sub>c3</sub> = 0 volts	—	
Class A Amplifier ♦	65	—	1.0	9.0	—	3,750§	6,700	25	—	—	4BX8¶
Class A Amplifier ♦	150	—	R <sub>k</sub> = 220	10	—	5,300§	6,800	36	—	—	4BZ7¶
Class A Amplifier ♦	125	—	R <sub>k</sub> = 100	10	—	5,600§	8,000	45	—	—	4BZ8¶

§ Approximate.

▲ Without external shield.

† Zero signal.

♦ Grids 3 and 5 are screen. Grid 4 is signal-input grid.

# Conversion transconductance.

◆ Maximum.

▼ Grids 2 and 4 are screen. Grid 3 is signal-input grid.

※ Screen supply voltage.

⊠ Absolute maximum rating.

‡ Plate-to-plate.

◆ Per section.

⊡ Design maximum rating.

⊕ For both sections.

\* Minimum.

¶ Heater warm-up time controlled for series-string service.

§ Plate supply voltage.

|| Input plate.

‡ The duration of the pulse voltage must not exceed 15 percent of one scanning cycle.

1—Section 1.

2—Section 2.

⊖ A resistor of 3 ohms must be put in series with heater.

Tube Type	Classification by Construction	Base Connections	Out-line Dwg	Filament Volts	Filament Amp	Max Plate Watts	Max Plate Volts	Max Screen Volts	Capacitance in Picofarads		
									Input	Output	Grid-plate
<b>4CB6</b>	Sharp-Cutoff RF Pentode	7CM	5-2	4.2	0.45	2.3	330	165	6.5	3.0	0.015
<b>4CE5</b>	Sharp-Cutoff RF Pentode	7BD	5-2	4.2	0.45	2.0	300	150	6.5	1.9	0.03
<b>4CX7</b>	Medium- $\mu$ Twin Triode	9FC	6-2	4.2	0.6	2.0	250	—	2.4 <sub>1</sub>	1.3 <sub>1</sub>	1.2 <sub>1</sub>
<b>4DT6</b>	Sharp-Cutoff Pentode	7EN	5-2	4.2	0.45	1.5	300	150	I <sub>c1</sub> = 0.6 ma		
<b>5AM8</b>	Diode Sharp-Cutoff RF Pentode	9CY	6-2	4.7	0.6	2.8	300	150	6.0	3.4	0.015
<b>5AN8</b>	Triode-Pentode	9DA	6-2	4.7	0.6	2.0	300	150	Diode Section		
						2.6	300	—	Pentode Section		
									Triode Section		
<b>5AQ5</b>	Beam Power Amplifier	7BZ	5-3	4.7	0.6	12	250	250	Pentode Connection		
						9.0	250	—	Triode Connection (G <sub>2</sub> & P tied)		
<b>5AR4</b>	Full-Wave High-Vacuum Rectifier	5DA	T-X	5.0	1.9	—	—	—	—	—	—
<b>5AS4</b>	Full-Wave High-Vacuum Rectifier	5T	16-3	5.0	3.0	—	Tube Voltage Drop: $\blacklozenge$ 50 v at 275 ma d-c				
<b>5AS8</b>	Diode Sharp-Cutoff RF Pentode	9DS	6-2	4.7	0.6	2.5	300	150	Pentode Section		
									Diode Section		
<b>5AT8</b>	Triode-Pentode	9DW	6-2	4.7	0.6	2.0	250	250	Pentode Section		
						1.5	250	—	Triode Section		
<b>5AU4</b>	Full-Wave High-Vacuum Rectifier	5T	T-X	5.0	4.5	—	Tube Voltage Drop: $\blacklozenge$ 50 v at 350 ma d-c				
<b>5AV8</b>	Triode-Pentode	9DZ	6-2	4.7	0.6	2.0	300	150	Pentode Section		
						2.5	300	—	Triode Section		
<b>5AW4</b>	Full-Wave High-Vacuum Rectifier	5T	T-X	5.0	3.7	—	Tube Voltage Drop: $\blacklozenge$ 46 v at 250 ma d-c				
<b>5AX4-GT</b>	Full-Wave, High-Vacuum Rectifier	5T	9-13	5.0	2.5	—	Tube Voltage Drop: $\blacklozenge$ 65 v at 175 ma d-c				
<b>5AZ4</b>	Full-Wave High-Vacuum Rectifier	5T	9-31	5.0	2.0	—	Tube Voltage Drop: $\blacklozenge$ 60 v at 125 ma d-c				
<b>5B8</b>	Triode-Pentode	9EC	6-2	4.7	0.6	2.0	300	150	Pentode Section		
						2.5	300	—	Triode Section		

Metal tubes are shown in bold-face type, miniature tubes in italics.

Ⓜ Subminiature type.

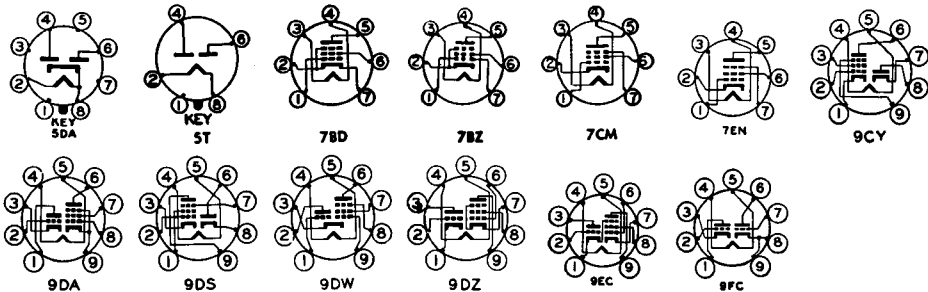



Service	Plate Volts	Screen Volts	Neg Grid Volts	Plate Milli-amperes	Screen Milli-amperes	R <sub>p</sub> , Ohms	G <sub>m</sub> , $\mu$ mhos	$\mu$ Factor	Load for Rated Output, Ohms	Power Output, Watts	Tube Type
Class A Amplifier	125	125	R <sub>k</sub> = 56	13	3.7	280,000§	8,000	—	—	—	4CB6¶
	125	125	3.0	2.8	—	—	—	—	—	—	
Class A Amplifier	125	125	1.0	11	2.8	300,000§	7,600	—	—	—	4CE5¶
Class A Amplifier ♦	150	—	R <sub>k</sub> = 220	9.0	—	6,100§	6,400	39	—	—	4CX7¶
Class A Amplifier FM Limiter-Discriminator	150	100	R <sub>k</sub> = 560	1.1	2.1	150,000§	800	E <sub>c3</sub> = 0 volts		—	4DT6¶
	250‡	100	R <sub>k</sub> = 560	0.22	5.5	E <sub>c3</sub> = -6.0 volts	—	—	270,000	—	
Class A Amplifier Video Detector	200	150	R <sub>k</sub> = 120	11.5	2.7	600,000§	7,000	—	—	—	5AM8¶
Max d-c output current = 5 ma; voltage drop: 10 v at 50 ma d-c											
Class A Amplifier Class A Amplifier	200	150	R <sub>k</sub> = 180	9.5	2.8	300,000§	6,200	—	—	—	5AN8¶
	200	—	6.0	13	—	5,750§	3,300	19	—	—	
Class A Amplifier Vertical Deflection Amplifier	180	180	8.5	29†	3.0†	58,000§	3,700	—	5,500	2.0	5AQ6¶
	250	250	12.5	45†	4.5†	52,000§	4,100	—	5,000	4.5	
	250	—	12.5	49.5	—	1,970§	4,800	9.5	—	—	
Max positive pulse plate voltage; ⊕ = 1.100 v; max plate dissipation = 9watts; max d-c cathode current = 35 ma											
Full-Wave Rectifier	Max d-c output current = 250 ma; max peak inverse voltage = 1,500 volts; rms supply voltage per plate = 450 volts; max peak current per plate = 750 ma										5AR4
Full-Wave Rectifier	Max d-c output current = 275 ma; max peak inverse voltage = 1,550 volts; rms supply voltage per plate = 450 volts; max peak current per plate = 1,000 ma										5AS4
Class A Amplifier Detector	200	150	R <sub>k</sub> = 180	9.5	3.0	300,000§	6,200	—	—	—	5AS8¶
Max d-c output current = 5.0 ma; max peak inverse voltage = 330 volts; max peak current = 50 ma											
Class A Amplifier Class A Amplifier	250	150	R <sub>k</sub> = 200	7.7	1.6	750,000§	4,600	—	—	—	5AT8¶
	100	—	R <sub>k</sub> = 100	8.5	—	6,900§	5,800	40	—	—	
Full-Wave Rectifier	Max d-c output current = 325 ma; max peak inverse voltage = 1400 volts; rms supply voltage per plate = 400 volts; max peak current per plate = 1075 ma										5AU4
Class A Amplifier Class A Amplifier	200	150	R <sub>k</sub> = 180	9.5	2.8	300,000§	6,200	—	—	—	5AV8¶
	200	—	6.0	13	—	5,750§	3,300	19	—	—	
Full-Wave Rectifier	Max d-c output current = 250 ma; max peak inverse voltage = 1550 volts; rms supply voltage per plate = 450 volts; max peak current per plate = 750 ma										5AW4
Full-Wave Rectifier	Max d-c output current = 175 ma; max peak inverse voltage = 1400 volts; max rms supply voltage per plate = 350 volts; max peak current per plate = 525 ma										5AX4-GT
Full-Wave Rectifier	Max d-c output current = 125 ma; max peak inverse voltage = 1400 volts; max rms supply voltage per plate = 350 volts; max peak current per plate = 375 ma										5AZ4
Class A Amplifier Class A Amplifier	200	150	R <sub>k</sub> = 180	9.5	2.8	300,000§	6,200	—	—	—	5B8¶
	200	—	6.0	13	—	5,750§	3,300	19	—	—	

§ Approximate.

▲ Without external shield.

† Zero signal.

‡ Grids 3 and 5 are screen. Grid 4 is signal-input grid.

# Conversion transconductance.

◆ Maximum.

♣ Grids 2 and 4 are screen. Grid 3 is signal-input grid.

✱ Screen supply voltage.

⊠ Absolute maximum rating.

‡ Plate-to-plate.

◆ Per section.

◆ Design maximum rating.

⊕ For both sections.

\* Minimum.

¶ Heater warm-up time controlled for series-string service.

§ Plate supply voltage.

|| Input plate.

3—The duration of the pulse voltage must not exceed 15 percent of one scanning cycle.

1—Section 1.

2—Section 2.

4—A resistor of 3 ohms must be put in series with heater.

Tube Type	Classification by Construction	Base Connections	Out-line Dwg	Filament Volts	Filament Amp	Max Plate Watts	Max Plate Volts	Max Screen Volts	Capacitance in Micromicrofarads		
									Input	Out-put	Grid-plate
<i>5BE8</i> ¶	Triode-Pentode	9EG	6-2	4.7	0.6	2.8 2.5	300 300	150 —	Pentode Section Triode Section		
<i>5BK7-A</i> ¶	High-Frequency Twin Triode	9AJ	6-2	4.7	0.6	2.7♣	300	—	3.0▲	1.01▲ 0.92▲	1.8▲
<i>5BQ7-A</i> ¶	High-Frequency Twin Triode	9AJ	6-2	5.6	0.45	2.0♣	250	—	2.6 <sub>1</sub>	1.2 <sub>1</sub>	1.2
<i>5BR8</i> ¶	Triode-Pentode	9FA	6-2	4.7	0.6	2.8 2.7	300 300	150 —	Pentode Section Triode Section		
<i>5BT8</i> ¶	Duplex-Diode Pentode	9FE	6-2	4.7	0.6	2.0	300	150	7.0▲	2.3▲	0.04♣▲
<i>5BZ7</i> ¶	High-Frequency Twin Triode	9AJ	6-2	5.6	0.45	2.0♣	250	—	2.6 <sub>1</sub>	1.2 <sub>1</sub>	1.2
<i>5CG8</i> ¶	Triode-Pentode	9GF	6-2	4.7	0.6	2.0 1.5	250 250	250✱ —	Pentode Section Triode Section		
<i>5CL8</i> ¶	Triode-Tetrode	9FX	6-2	4.7	0.6	2.8 2.7	300 300	150 —	Tetrode Section Triode Section		
<i>5CM8</i> ¶	Triode-Pentode	9FZ	6-2	4.7	0.6	2.0 1.0	300 300	150 —	Pentode Section Triode Section		
<i>5J6</i> ¶	Medium-Mu Twin Triode	7BF	5-2	4.7	0.6	1.5♣ 1.5♣	300 300	— —	2.6	1.6 <sub>1</sub> 1.0 <sub>2</sub>	1.5
<b>5R4-G</b> <b>5R4-GY</b> <b>5R4-GYA</b>	Full-Wave High-Vacuum Rectifier	5T	16-3 16-3 T-X	5.0	2.0	—	Tube Voltage Drop: ♣ 67 v at 250 ma d-c				
<b>5T4</b>	Full-Wave High-Vacuum Rectifier	5T	10-1	5.0	2.0	—	Tube Voltage Drop: ♣ 45 v at 225 ma d-c				
<i>5T8</i> ¶	Triple Diode High-Mu Triode	9E	6-2	4.7	0.6	1.0	300	—	1.6▲	1.0▲	2.2▲
<b>5U4-G</b>	Full-Wave High-Vacuum Rectifier	5T	16-3	5.0	3.0	—	Tube Voltage Drop: ♣ 44 v at 225 ma d-c				
<b>5U4-GA</b>	Full-Wave High-Vacuum Rectifier	5T	T-X	5.0	3.0	—	Tube Voltage Drop: ♣ 44 v at 225 ma d-c				
<b>5U4-GB</b>	Full-Wave High-Vacuum Rectifier	5T	T-X	5.0	3.0	—	Tube Voltage Drop: ♣ 50 v at 275 ma d-c				

Metal tubes are shown in bold-face type, miniature tubes in italics.

⊛Subminiature type.

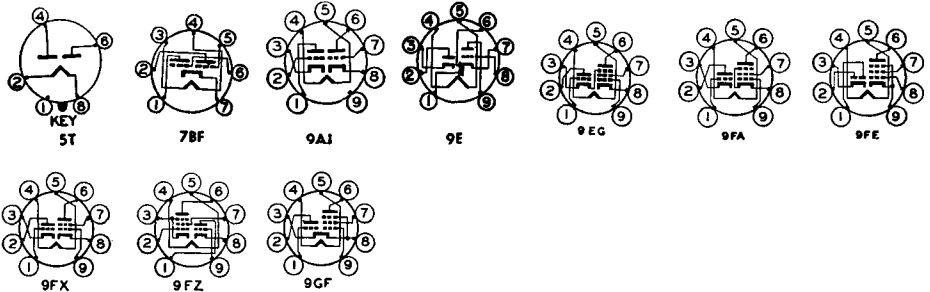

Service	Plate Volts	Screen Volts	Neg Grid Volts	Plate Milli-amperes	Screen Milli-amperes	R <sub>p</sub> Ohms	G <sub>m</sub> μmhos	μ Factor	Load for Rated Output, Ohms	Power Output, Watts	Tube Type
Class A Amplifier Class A Amplifier	250	110	R = 68	10	3.5	400,000§	5,200	—	—	—	5BE8¶
	150	—	R <sub>k</sub> = 56	18	—	5,000§	8,500	40	—	—	
Class A Amplifier ♠	150	—	R <sub>k</sub> = 56	18	—	4,600§	9,300	43	—	—	5BK7-A¶
Class A Amplifier ♠	150	—	R = 220	9.0	—	5,900§	6,400	38	—	—	5BQ7-A¶
Class A Amplifier Class A Amplifier	250	110	R <sub>k</sub> = 68	10	3.5	400,000§	5,200	—	—	—	5BR8¶
	150	—	R <sub>k</sub> = 56	18	—	5,000§	8,500	40	—	—	
Class A Amplifier Horizontal Phase Detector	200	150	R <sub>k</sub> = 180	9.5	2.8	300,000§	6,200	—	—	—	5BT8¶
Max d-c output current ♠ = 1.0 ma; voltage drop ♠: 10 volts at 8.0 ma d-c											
Class A Amplifier ♠	150	—	R <sub>k</sub> = 220	10	—	5,300§	6,800	36	—	—	5BZ7¶
Class A Amplifier Class A Amplifier	250	150	R = 200	7.7	1.6	750,000§	4,600	—	—	—	5CG8¶
	100	—	R <sub>k</sub> = 100	8.5	—	6,900§	5,800	40	—	—	
Class A Amplifier Class A Amplifier	125	125	1.0	12	4.0	100,000§	5,800	—	—	—	5CL8¶
	125	—	R = 56	15	—	5,000§	8,000	40	—	—	
Class A Amplifier Class A Amplifier	200	150	R <sub>k</sub> = 180	9.5	2.8	600,000§	6,200	—	—	—	5CM8¶
	250	—	2.0	1.8	—	50,000§	2,000	100	—	—	
Class A Amplifier ♠ Class C Amplifier	100	—	R <sub>k</sub> = 50 ⊕	8.5	—	7,100§	5,300	38	—	—	5J6¶
	150	—	10.0	30	—	Input Signal = 0.35 watt§ I <sub>gr1</sub> = 16 ma d-c§	—	—	—	3.5§	
Full-Wave Rectifier	Max d-c output current = 250 ma; max peak inverse voltage = 2800 volts; rms supply voltage per plate = 750 volts; max peak current per plate = 650 ma										5R4-G 5R4-GY 5R4-GYA
Full-Wave Rectifier	Max d-c output current = 225 ma; max peak inverse voltage = 1550 volts; max rms supply voltage per plate = 450 volts; max peak current per plate = 675 ma										5T4
Class A Amplifier	250	—	3.0	1.0	—	58,000§	1,200	70	—	—	5T8¶
	100	—	1.0	0.8	—	54,000§	1,300	70	—	—	
Full-Wave Rectifier	Max d-c output current = 225 ma; max peak inverse voltage = 1550 volts; rms supply voltage per plate = 450 volts; max peak current per plate = 800 ma										5U4-G
Full-Wave Rectifier	Max d-c output current = 250 ma; max peak inverse voltage = 1550 volts; rms supply voltage per plate = 450 volts; max peak current per plate = 900 ma										5U4-GA
Full-Wave Rectifier	Max d-c output current = 275 ma; max peak inverse voltage = 1550 volts; rms supply voltage per plate = 450 volts; max peak current per plate = 1000 ma										5U4-GB

§ Approximate.

▲ Without external shield.

† Zero signal.

◆ Grids 3 and 5 are screen. Grid 4 is signal-input grid.

# Conversion transconductance.

♣ Maximum.

♥ Grids 2 and 4 are screen. Grid 3 is signal-input grid.

✱ Screen supply voltage.

⊠ Absolute maximum rating.

‡ Plate-to-plate.

♠ Per section.

⊕ Design maximum rating.

⊕ For both sections.

\* Minimum.

¶ Heater warm-up time controlled for series-string service.

§ Plate supply voltage.

|| Input plate.

♣ The duration of the pulse voltage must not exceed 15 percent of one scanning cycle.

1—Section 1.

2—Section 2.

4—A resistor of 3 ohms must be put in series with heater.

Tube Type	Classification by Construction	Base Connections	Out-line Dwg	Fila-ment Volts	Fila-ment Amp	Max Plate Watts	Max Plate Volts	Max Screen Volts	Capacitance in Micromicrofarads		
									Input	Out-put	Grid-plate
<b>5U8</b>	Triode-Pentode	9AE	6-2	4.7	0.6	2.8 2.7	300 300	150 —	Pentode Section Triode Section		
<b>5V3</b>	Full-Wave High-Vacuum Rectifier	5T	T-X	5.0	3.8	—	Tube Voltage Drop: ♦ 47 v at 350 ma d-c				
<b>5V4-G</b> <b>5V4-GA</b>	Full-Wave High-Vacuum Rectifier	5L	14-3 T-X	5.0	2.0	—	Tube Voltage Drop: ♦ 25 v at 175 ma d-c				
<b>5V6-GT</b>	Beam Power Amplifier	7AC	9-11 or 9-41	4.7	0.6	12 — 9.0	315 — 315	285 — —	Single Tube 2 Tubes, Push-Pull Triode Connection (G2 & P tied)		
<b>5W4</b> <b>5W4-GT</b>	Full-Wave High-Vacuum Rectifier	5T	8-6 9-13	5.0	1.5	—	Tube Voltage Drop: ♦ 45 v at 100 ma d-c				
<b>5X4-G</b>	Full-Wave High-Vacuum Rectifier	5Q	16-3	5.0	3.0	—	Tube Voltage Drop: ♦ 58 v at 225 ma d-c				
<b>5X4-GA</b>	Full-Wave High-Vacuum Rectifier	5Q	T-X	5.0	3.0	—	Tube Voltage Drop: ♦ 47 v at 250 ma d-c				
<b>5X8</b>	Triode-Pentode Converter	9AK	6-2	4.7	0.6	2.0 1.5	250 250	250 —	Pentode Section Triode Section		
<b>5Y3-G</b>	Full-Wave High-Vacuum Rectifier	5T	14-3	5.0	2.0	—	Tube Voltage Drop: ♦ 60 v at 125 ma d-c				
<b>5Y3-GA</b> <b>5Y3-GT</b>	Full-Wave High-Vacuum Rectifier	5T	T-X 9-13 or 9-42	5.0	2.0	—	Tube Voltage Drop: ♦ 60 v at 125 ma d-c				
<b>5Y4-G</b>	Full-Wave High-Vacuum Rectifier	5Q	14-3	5.0	2.0	—	Tube Voltage Drop: ♦ 60 v at 125 ma d-c				
<b>5Y4-GA</b> <b>5Y4-GT</b>	Full-Wave High-Vacuum Rectifier	5Q	T-X 9-13 or 9-42	5.0	2.0	—	Tube Voltage Drop: ♦ 60 v at 125 ma d-c				
<b>5Z3</b>	Full-Wave High-Vacuum Rectifier	4C	16-1	5.0	3.0	—	Tube Voltage Drop: ♦ 58 v at 225 ma d-c				
<b>5Z4</b> <b>5Z4-GT</b>	Full-Wave High-Vacuum Rectifier	5L 5L	8-6 9-11	5.0 5.0	2.0 2.0	— —	Tube Voltage Drop: ♦ 20 v at 125 ma				
<b>6A3</b>	Power Amplifier Triode	4D	16-1	6.3	1.0	—	325	Single tube 2 tubes, push-pull			

Metal tubes are shown in bold-face type, miniature tubes in italics.

©Subminiature type.

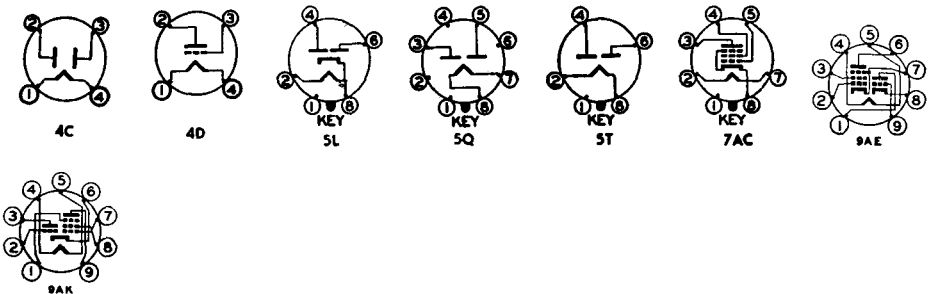

Service	Plate Volts	Screen Volts	Neg Grid Volts	Plate Milli-am-peres	Screen Milli-am-peres	R <sub>p</sub> ' Ohms	G <sub>m</sub> ' μmhos	μ Fac-tor	Load for Rated Out-put, Ohms	Power Out-put, Watts	Tube Type
Class A Amplifier Class A Amplifier	250	110	R <sub>k</sub> = 68	10	3.5	400,000§	5,200	—	—	—	5U8¶
	150	—	R <sub>k</sub> = 56	18	—	5,000§	8,500	40	—	—	
Full-Wave Rectifier	Max d-c output current = 350 ma; max peak inverse voltage = 1,400 volts; rms supply voltage per plate = 425 volts; max peak current per plate = 1,200 ma										5V3
Full-Wave Rectifier	Max d-c output current = 175 ma; max peak inverse voltage = 1400 volts; rms supply voltage per plate = 375 volts; max peak current per plate = 525 ma										5V4-G 5V4-GA
Class A Amplifier Class AB <sub>1</sub> Amplifier Vertical Deflection Amplifier	315	225	13	34†	2.2†	80,000§	3,750	—	8,500	5.5	5V6-GT¶
	250	250	12.5	45†	4.5†	50,000§	4,100	—	5,000	4.5	
	180	180	8.5	29†	3.0†	50,000§	3,700	—	5,500	2.0	
	285	285	19	70†	4.0†	—	—	—	8,000†	14	
	250	250	15	70†	5.0†	—	—	—	10,000†	10	
250	—	12.5	49.5	—	—	1,960§	5,000	9.8	—	—	
Max positive pulse plate voltage; □ = 1200 v; max plate dissipation = 9 watts; max d-c cathode current = 35 ma											
Full-Wave Rectifier	Max d-c output current = 100 ma; max peak inverse voltage = 1400 volts; max rms supply voltage per plate = 350 volts; max peak current per plate = 300 ma										5W4 5W4-GT
Full-Wave Rectifier	Max d-c output current = 225 ma; max peak inverse voltage = 1550 volts; max rms supply voltage per plate = 450 volts; max peak current per plate = 675 ma										5X4-G
Full-Wave Rectifier	Max d-c output current = 250 ma; max peak inverse voltage = 1550 volts; rms supply voltage per plate = 450 volts; max peak current per plate = 900 ma										5X4-GA
Class A Amplifier Class A Amplifier	250	150	R <sub>k</sub> = 200	7.7	1.6	750,000§	4,600	—	—	—	5X8¶
	100	—	R <sub>k</sub> = 100	8.5	—	6,900§	5,800	40	—	—	
Full-Wave Rectifier	Max d-c output current = 125 ma; max peak inverse voltage = 1400 volts; max rms supply voltage per plate = 350 volts; max peak current per plate = 375 ma										5Y3-G
Full-Wave Rectifier	Max d-c output current = 125 ma; max peak inverse voltage = 1400 volts; rms supply voltage per plate = 350 volts; max peak current per plate = 440 ma										5Y3-GA 5Y3-GT
Full-Wave Rectifier	Max d-c output current = 125 ma; max peak inverse voltage = 1400 volts; rms supply voltage per plate = 350 volts; max peak current per plate = 375 ma										5Y4-G
Full-Wave Rectifier	Max d-c output current = 125 ma; max peak inverse voltage = 1400 volts; rms supply voltage per plate = 350 volts; max peak current per plate = 400 ma										5Y4-GA 5Y4-GT
Full-Wave Rectifier	Max d-c output current = 225 ma; max peak inverse voltage = 1550 volts; max rms supply voltage per plate = 450 volts; max peak current per plate = 675 ma										5Z3
Full-Wave Rectifier	Max d-c output current = 125 ma; max peak inverse voltage = 1400 volts; max rms supply voltage per plate = 350 volts; max peak current per plate = 375 ma										5Z4 5Z4-GT
Class A Amplifier Class AB <sub>1</sub> Amplifier	250	—	45	60†	—	800	5,250	4.2	2,500	3.2	6A3
	325	—	68	80†	—	—	—	—	3,000†	15	

§ Approximate.

▲ Without external shield.

† Zero signal.

‡ Grids 3 and 5 are screen. Grid 4 is signal-input grid.

# Conversion transconductance.

♣ Maximum.

▼ Grids 2 and 4 are screen. Grid 3 is signal-input grid.

\* Screen supply voltage.

□ Absolute maximum rating.

‡ Plate-to-plate.

♣ Per section.

◆ Design maximum rating.

⊕ For both sections.

\* Minimum.

¶ Heater warm-up time controlled for series-string service.

§ Plate supply voltage.

|| Input plate.

— The duration of the pulse voltage must not exceed 15 percent of one scanning cycle.

1—Section 1.

2—Section 2.

4—A resistor of 3 ohms must be put in series with heater.

Tube Type	Classification by Construction	Base Connections	Out-line Dwg	Fila-ment Volts	Fila-ment Amp	Max Plate Watts	Max Plate Volts	Max Screen Volts	Capacitance in Micromicrofarads		
									Input	Out-put	Grid-plate
<b>6A4/LA</b>	Power Amplifier Pentode	5B	14-1	6.3	0.3	—	180	180	—	—	—
<b>6A5-G</b>	Power Amplifier Triode	6T	16-3	6.3	1.25	—	250	—	Single Tube 2 tubes, push-pull		
<b>6A6</b>	Twin Triode Power Amplifier	7B	14-1	6.3	0.8	1.0♣ —	300	—	Both Sections in Push-pull Both Sections in Parallel		
<b>6A7</b>	Pentagrid Converter	7C♠	12-6	6.3	0.3	1.0	300	100	Osc $I_{g1} = 0.4$ ma $R_{g1} = 50,000$ ohms		
<b>6A8</b> <b>6A8-G</b> <b>6A8-GT</b>	Pentagrid Converter	8A♠	8-4 12-8 9-18	6.3	0.3	1.0	300	100	Osc $I_{g1} = 0.4$ ma $R_{g1} = 50,000$ ohms		
<i>6AB4</i>	High-Frequency Triode	5CE	5-2	6.3	0.15	2.5	300	—	2.2	1.4	1.5
<b>6AB5/6N5</b>	Electron-Ray Indicator	6R	9-26	6.3	0.15	—	180§	Max target voltage = 180 Min target voltage = 125			
<b>6AB7/1853</b>	Remote-Cutoff RF Pentode	8N	8-1	6.3	0.45	3.75	300	200	8.0	5.0	0.015♣
<b>6AB8</b>	Triode-Pentode	9AT	6-3	6.3	0.3	3.5 1.0	350 200	250 —	Pentode Section Triode Section		
<b>6AC5-GT</b>	Triode Power Amplifier	6Q	9-11	6.3	0.4	10	250	—	2 tubes, Push-pull		
<b>6AC6-GT</b>	Dynamic-Coupled Power Amplifier	7W	9-11	6.3	1.1	8.5 1.3	180	—	—	—	—
<b>6AC7</b>	RF Pentode	8N	8-1	6.3	0.45	3.0	300	150	11	5	0.015♣
<b>6AD4</b> ⊙	High-Mu Triode	8DK	3-1	6.3	0.15	0.3	150	—	1.9	2.2	0.7
<b>6AD6-G</b>	Twin Electron-Ray Indicator	7AG	9-3	6.3	0.15	—	Max target voltage = 150 Min target voltage = 100				
<b>6AD7-G</b>	Triode-Power Amplifier Pentode	8AY	14-3	6.3	0.85	1.0 8.5	285 375	— 285	Triode section Pentode section		
<b>6AD8</b>	Duplex-Diode RF Pentode	9T	6-3	6.3	0.3	2.0	250	125	—	—	—
<b>6AE5-GT</b>	Low-Mu Triode	6Q	9-11	6.3	0.3	2.5	300	—	—	—	—

Metal tubes are shown in bold-face type, miniature tubes in italics. ⊙Subminiature type.

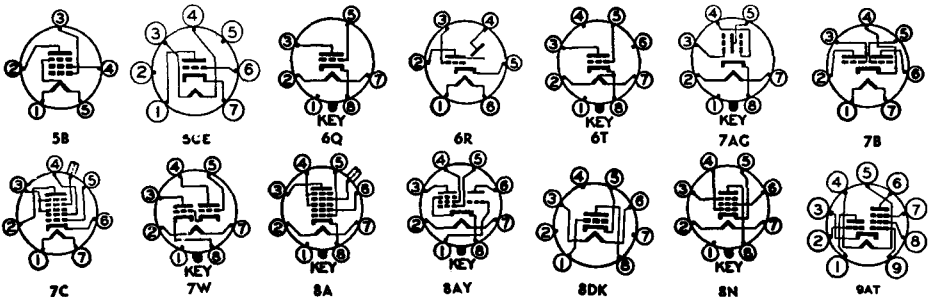

Service	Plate Volts	Screen Volts	Neg Grid Volts	Plate Milli-am-peres	Screen Milli-am-peres	R <sub>p</sub> , Ohms	G <sub>m</sub> , μmhos	μ Factor	Load for Rated Out-put, Ohms	Power Out-put, Watts	Tube Type
Class A Amplifier	180	180	12	22†	3.9†	45,400§	2,200	—	8,000	1.4	6A4/LA
Class A Amplifier Class A Amplifier	250	—	45	60†	—	800	5,250	4.2	2,500	3.75	6A5-G
	325	—	68	80†	—	—	—	—	3,000	15	
Class B Amplifier Class A Amplifier	300	—	0	35†	—	—	—	—	8,000	10§	6A6
	294	—	6.0	7.0	—	11,000	3,200	35	†	—	
Converter	250	100	3.0	3.5	2.7	360,000§	550 #	E <sub>c2</sub> (Osc Plate) = 250 thru 20,000 ohms I <sub>c2</sub> = 4.0 ma			6A7
Converter	250	100	3.0	3.5	2.7	360,000§	550 #	E <sub>c2</sub> (Osc Plate) = 250 thru 20,000 ohms I <sub>c2</sub> = 4.0 ma			6A8 6A8-G 6A8-GT
Class A Amplifier	250	—	R <sub>k</sub> = 200	10	—	10,900	5500	60	—	—	6AB4
	100	—	R <sub>k</sub> = 270	3.7	—	15,000	4000	60	—	—	
Tuning Indicator	Plate voltage = 135 thru 0.25 meg; target voltage = 135 (E <sub>g</sub> = -10, shadow = 0°) (E <sub>g</sub> = 0 volt, shadow = 90°, plate current = 0.5 ma, target current § = 2 ma)										6AB5/6N5
Class A Amplifier	300	200	3.0	12.5	3.2	700,000§	5000	—	—	—	6AB7/1853
Class A Amplifier Class A Amplifier	200	200	7.7	17.5	3.3	150,000	3400	—	11,000	1.4	6AB8
	100	—	2	4	—	—	1350	18	—	—	
Class B Amplifier	250	—	0	5.0†	—	Input signal = .950 watt			10,000 ‡	8.0§	6AC5-GT
Class A Amplifier	180	180	0	45.0	7.0	18,000§	3,000	—	3,500	3.6	6AC6-GT
Class A Amplifier	300	150	R <sub>k</sub> = 160	10	2.5	1,000,000§	9,000	—	—	—	6AC7
Class A Amplifier	100	—	R <sub>k</sub> = 820	1.4	—	35,000	2000	70	—	—	6AD4⊙
Tuning Indicator ♦	Target voltage = 150 (Ray control = +75 volts, shadow = 0°) (Ray control = +8 volts, shadow = 90°)										6AD6-G
Class A Amplifier Class A Amplifier	250	—	25	3.7	—	19,000§	325	6.0	—	—	6AD7-G
	250	250	16.5	34†	6.5†	80,000§	2,500	—	7,000	3.2	
Class A Amplifier	250	85	2.0	6.7	2.3	1,000,000	1,100	—	—	—	6AD8
Class A Amplifier	95	—	15	7.0	—	3,500	1,200	4.2	—	—	6AE5-GT



9T

- § Approximate.
- ▲ Without external shield.
- † Zero signal.
- ♦ Grids 3 and 5 are screen. Grid 4 is signal-input grid.
- # Conversion transconductance.
- ♣ Maximum.
- ♥ Grids 2 and 4 are screen. Grid 3 is signal-input grid.
- \* Screen supply voltage.
- ⊙ Absolute maximum rating.
- ‡ Plate-to-plate.
- ♠ Per section.
- ◆ Design maximum rating.

- ⊕ For both sections.
- \* Minimum.
- ¶ Heater warm-up time controlled for series-string service.
- ‡ Plate supply voltage.
- || Input plate.
- ⊖ The duration of the pulse voltage must not exceed 15 percent of one scanning cycle.
- 1—Section 1.
- 2—Section 2.
- 4—A resistor of 3 ohms must be put in series with heater.

Tube Type	Classification by Construction	Base Connections	Out-line Dwg	Fila-ment Volts	Fila-ment Amp	Max Plate Watts	Max Plate Volts	Max Screen Volts	Capacitance in Micromicrofarads		
									Input	Out-put	Grid-plate
6AE6-G	Single-Grid Twin-Plate Control Tube	7AH	12-7	6.3	0.15	—	250	Remote-cut-off plate (Pin 3) Sharp-cut-off plate (Pin 4)			
6AE7-GT	Twin-Input Triode	7AX	9-11	6.3	0.5	5.0	300	—	—	—	—
<i>6AE8</i>	Triode-Hexode Converter	8DU	T-X	6.3	0.3	—	250	100	Osc $E_{g1} = 10$ peak $R_{g1} = 50,000$ ohms		
<i>6AF4</i> <i>6AF4-A</i>	UHF Triode Oscillator	7DK	5-2 5-1	6.3	0.225	2.5 $\diamond$	150 $\diamond$	—	2.2 $\blacktriangle$	0.45 $\blacktriangle$	1.9 $\blacktriangle$
6AF5-G	Low-Mu Triode	6Q	12-7	6.3	0.3	—	180	—	—	—	—
6AF6-G	Twin Electron-Ray Indicator	7AG	9-1 or 9-36	6.3	0.15	—	—	Max target voltage = 250 Min target voltage = 125			
<i>6AG5</i>	Sharp-Cutoff RF Pentode	7BD	5-2	6.3	0.3	2.0 2.5	300 300	150 —	Pentode Connection Triode Connection ( $G_2$ & P tied)		
6AG7	Power Amplifier Pentode	8Y	8-6	6.3	0.65	9.0	300	300	13	7.5	0.06 $\clubsuit$
6AH4-GT	Low-Mu Triode	8EL	9-41	6.3	0.75	7.5	500	—	7.0 $\blacktriangle$	1.7 $\blacktriangle$	4.4 $\blacktriangle$
<i>6AH6</i>	Sharp-Cutoff RF Pentode	7BK	5-2	6.3	0.45	3.2	300	150	Pentode Connection Triode Connection ( $G_2$ , $G_3$ & P tied)		
6AH7-GT	Medium-Mu Twin-Triode	8BE	9-7	6.3	0.3	1.5 $\spadesuit$	180	—	—	—	—
<i>6AJ4</i>	UHF High-Mu Triode	9BX	6-1	6.3	0.225	2.0	150	—	—	—	—
<i>6AJ5</i>	Sharp-Cutoff RF Pentode	7BD	5-1	6.3	0.175	1.7	180	90	4.0	2.8	0.02 $\clubsuit$
6AJ7	RF Pentode	8N	8-1	6.3	0.45	3.0	300	150	11	5	0.015 $\clubsuit$
<i>6AJ8</i>	Triode-Heptode	9CA	6-3	6.3	0.3	1.7 0.8	300 250	125 —	Heptode Section Triode Section		
6AK4 $\odot$	Medium-Mu Triode	8DK	3-1	6.3	0.15	3.0	250	—	2.2	2.2	1.3
<i>6AK5</i>	Sharp-Cutoff RF Pentode	7BD	5-1	6.3	0.175	1.7	180	140	4.0	2.8	0.02 $\clubsuit$
<i>6AK6</i>	Power Amplifier Pentode	7BK	5-2	6.3	0.15	2.75	300	250	3.6 $\blacktriangle$	4.2 $\blacktriangle$	0.12 $\blacktriangle$

Metal tubes are shown in bold-face type, miniature tubes in *italics*.  $\odot$ Subminiature type.

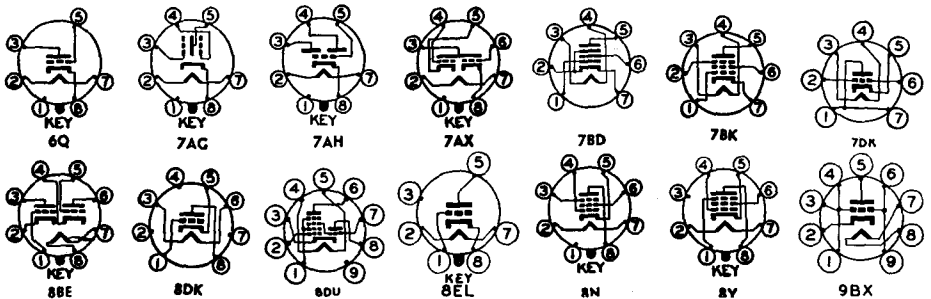



Service	Plate Volts	Screen Volts	Neg Grid Volts	Plate Milli-amperes	Screen Milli-amperes	R <sub>p</sub> , Ohms	G <sub>m</sub> , $\mu$ mhos	$\mu$ Factor	Load for Rated Output, Ohms	Power Output, Watts	Tube Type
Class A Amplifier	250 250	—	1.5 1.5	6.5 4.5	—	25,000§ 35,000§	1,000 950	25 33	—	—	6AE6-G
Class A Amplifier ♠	250	—	13.5	5	—	9,300	1,500	14	—	—	6AE7-GT
Converter	250	75	0	4.5	3.4	700,000	780 #	E <sub>b</sub> (Triode Osc) = 100 I <sub>b</sub> (Triode) = 4.5 ma		—	6AE8
Class A Amplifier	80	—	R <sub>k</sub> = 150	13.5	—	2,100§	6,500	17.5	—	—	6AF4 6AF4-A
Class A Amplifier	180	—	18	7.0	—	4,900	1,500	7.4	—	—	6AF5-G
Tuning Indicator ♠	Target voltage = 250 (Ray control = +155 volts, shadow = 0°) (Ray control = 0 v, shadow = 100°, target current § = 3.75 ma)										6AF6-G
Class A Amplifier	250	150	R <sub>k</sub> = 180	6.5	2.0	800,000§	5,000	—	—	—	6AG5
Class A Amplifier	250	—	R <sub>k</sub> = 820	5.5	—	10,000	3,800	42	—	—	6AG5
Class A Amplifier	300	150	3.0	30†	7.0†	130,000§	11,000	—	10,000	3.0	6AG7
Vertical Deflection Amplifier	250	—	23	30	—	1,780§	4,500	8.0	—	—	6AH4-GT
Max positive pulse plate voltage, $\square$ = 2000 v; max d-c cathode current = 60 ma											
Class A Amplifier	300	150	R <sub>k</sub> = 160	10	2.5	500,000§	9,000	—	—	—	6AH6
Class A Amplifier	150	—	R <sub>k</sub> = 160	12.5	—	3,600§	11,000	40	—	—	6AH6
Class A Amplifier ♠	180	—	6.5	7.6	—	8,400	1,900	16	—	—	6AH7-GT
Class A Amplifier	125	—	R <sub>k</sub> = 68	16	—	4,200§	10,000	42	—	—	6AJ4
Class A Amplifier	28	28	1.0	2.7	1.0	100,000§	2,500	—	—	—	6AJ5
Class A Amplifier	300	150	R <sub>k</sub> = 160	10	2.5	1,000,000§	9,000	—	—	—	6AJ7
Class A Amplifier	250	102	2.0	6.5	3.8	700,000§	2,400	—	E <sub>c3</sub> = 0 v		6AJ8
Class A Amplifier	100	—	0	13.5	—	5,900§	3,700	22	—	—	6AJ8
Class A Amplifier	200	—	R <sub>k</sub> = 680	9.5	—	5,300§	3,800	20	—	—	6AK4 ⊙
Class A Amplifier	180	120	R <sub>k</sub> = 180	7.7	2.4	500,000§	5,100	—	—	—	6AK6
Class A Amplifier	120	120	R <sub>k</sub> = 180	7.5	2.5	300,000§	5,000	—	—	—	6AK6
Class A Amplifier	180	180	9.0	15†	2.5†	200,000	2,300	—	10,000	1.1	6AK6

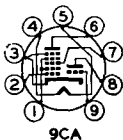

9CA

§ Approximate.

▲ Without external shield.

† Zero signal.

◆ Grids 3 and 5 are screen. Grid 4 is signal-

input grid.

# Conversion transconductance.

♣ Maximum.

♥ Grids 2 and 4 are screen. Grid 3 is signal-

input grid.

✱ Screen supply voltage.

⊠ Absolute maximum rating.

‡ Plate-to-plate.

♠ Per section.

◆ Design maximum rating.

⊕ For both sections.

\* Minimum.

¶ Heater warm-up time controlled for series-string service.

§ Plate supply voltage.

|| Input plate.

‡ The duration of the pulse voltage must not exceed 15 percent of one scanning cycle.

1—Section 1.

2—Section 2.

4—A resistor of 3 ohms must be put in series with heater.

Tube Type	Classification by Construction	Base Connections	Outline Dwg	Filament Volts	Filament Amp	Max Plate Watts	Max Plate Volts	Max Screen Volts	Capacitance in Micromicrofarads		
									Input	Out-put	Grid-plate
<b>6AK7</b>	Power Amplifier Pentode	8Y	8-6	6.3	0.65	9.0	300	300	13	7.5	0.06 ♣
<b>6AK8</b>	Triple-Diode High-Mu Triode	9E	6-3	6.3	0.45	1.0	300	—	1.9▲	1.6▲	2.2▲
<b>6AL6</b>	Twin Diode	6BT	5-1	6.3	0.3	—	Tube Voltage Drop: ♣ 10 v at 60 ma d-c				
<b>6AL6-G</b>	Beam Power Amplifier	6AM	T-X	6.3	0.9	18.5	350	300	—	—	—
<b>6AL7-GT</b>	Electron-Ray Indicator	8CH	9-7 or 9-39	6.3	0.15	—	—	Max target voltage = 365 Min target voltage = 220			
<b>6AM4</b>	UHF High-Mu Triode	9BX	6-1	6.3	0.225	2.0	200	—	—	—	—
<b>6AM5</b>	Power Amplifier Pentode	6CH	5-2	6.3	0.2	4.0	250	250	Single Tube 2 tubes, push-pull		
<b>6AM6</b>	Sharp-Cutoff RF Pentode	7DB	5-2	6.3	0.3	2.5	300	250	Pentode Connection Triode Connection (G <sub>2</sub> & P tied)		
<b>6AM8</b> <b>6AM8-A</b> ¶	Diode Sharp-Cutoff RF Pentode	9CY	6-2	6.3	0.45	2.8	300	150	6.0	3.4	0.015 ♣
<b>6AN4</b>	UHF High-Mu Triode	7DK	5-1	6.3	0.225	4.0	300	—	—	—	—
<b>6AN5</b>	Beam Power Amplifier	7BD	5-2	6.3	0.45	4.2	120	120	9.0	4.8	0.075 ♣
<b>6AN6</b>	Quadruple Diode	7BJ	5-2	6.3	0.2	—	—	Tube Voltage Drop: ♣ 9.0 v at 6.6 ma			
<b>6AN7</b>	Triode-Hexode Converter	9Q	6-3	6.3	0.23	—	250	125	Osc I <sub>g1</sub> = 0.35 ma R <sub>g1</sub> = 22,000 ohms		
<b>6AN8</b> <b>6AN8-A</b> ¶	Triode-Pentode	9DA	6-2	6.3	0.45	2.0 2.6	300 300	150	Pentode Section Triode Section		
<b>6AQ4</b>	High-Mu Triode	7DT	5-2	6.3	0.3	2.5	250	—	8.5	0.2	2.5
<b>6AQ6</b> <b>6AQ6-A</b> ¶	Beam Power Amplifier	7BZ	5-3	6.3	0.45	12 9.0	250 250	250	Pentode Connection Triode Connection (G <sub>2</sub> & P tied)		

Metal tubes are shown in bold-face type, miniature tubes in italics.

⊙Subminiature type.

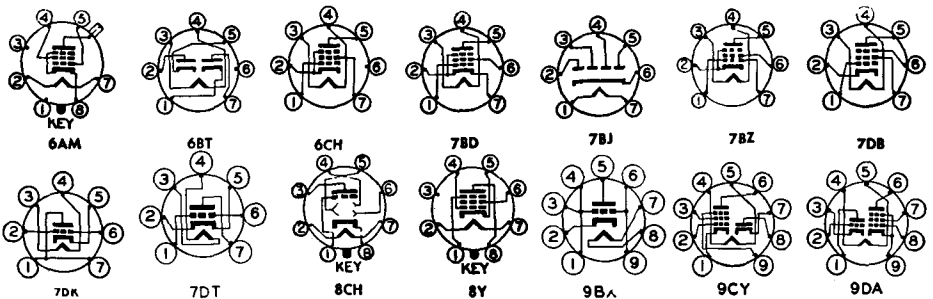

Service	Plate Volts	Screen Volts	Neg Grid Volts	Plate Milli-amperes	Screen Milli-amperes	R <sub>p</sub> , Ohms	G <sub>m</sub> , μmhos	μ Factor	Load for Rated Out-put, Ohms	Power Out-put, Watts	Tube Type
Class A Amplifier	300	150	3.0	30†	7.0†	130,000	11,000	—	10,000	3.0	6AK7
Class A Amplifier	250 100	—	3.0 1.0	1.0 0.8	—	58,000\$ 54,000\$	1,200 1,300	70	—	—	6AK8
Half-Wave Rectifier	Max d-c output current per plate = 9 ma; max peak inverse voltage = 330 volts; max rms supply voltage per plate = 117 volts; max peak current per plate = 54 ma										6AL5
Class A Amplifier	250	250	14	72†	5.0†	22,500	6,000	—	2,500	6.5	6AL6-G
FM/AM Tuning Indicator	Target voltage = 315 volts; cathode resistor = 3,300 ohms; grid voltage = 0 volts; pin 6 electrode controls top left quarter of fluorescent area, pin 4 electrode controls top right quarter of fluorescent area, and pin 5 electrode controls bottom half of fluorescent area when the tube is mounted horizontally with a plane passing through pins 4 and 8 vertical and with pin 4 on top.										6AL7-GT
Class A Amplifier	200	—	R <sub>k</sub> = 100	10	—	8,700\$	9,800	85	—	—	6AM4
Class A Amplifier Class AB <sub>1</sub> Amplifier	250	250	13.5	16	2.4	130,000	2,600	—	16,000	1.4	6AM5
	250	250	19	10†	1.3†	—	—	—	20,000†	4.8	
Class A Amplifier Class A Amplifier	250	250	2.0	10	2.5	1,000,000\$	7,500	—	—	—	6AM6
	250	—	2.0	12.5	—	7,500\$	9,300	70	—	—	
Class A Amplifier Video Detector	200	150	R <sub>k</sub> = 120	11.5	2.7	600,000\$	7,000	—	—	—	6AM8
	Max d-c output current = 5 ma; voltage drop: 10 v at 50 ma d-c										6AM8-A ¶
Class A Amplifier	200	—	R <sub>k</sub> = 100	13	—	7,000	10,000	70	—	—	6AN4
Class A Amplifier	120	120	R <sub>k</sub> = 120	35	12	12,500\$	8,000	—	2,500	1.3	6AN5
Half-Wave Rectifier	Max d-c output current per plate = 8.0 ma; max peak inverse voltage = 210 volts; rms supply voltage per plate = 75 volts; max peak current per plate = 45 ma										6AN6
Converter	250	85	2.0	3.0	3.0	1,000,000*	750 #	E <sub>b</sub> (Triode Osc) = 250 thru 33,000 ohms I <sub>b</sub> (Triode) = 5.1 ma			6AN7
Class A Amplifier Class A Amplifier	200	150	R <sub>k</sub> = 180	9.5	2.8	300,000\$	6,200	—	—	—	6AN8
	200	—	6.0	13	—	5,750\$	3,300	19	—	—	6AN8-A ¶
Class A Amplifier	250	—	1.5	10	—	12,000\$	8,500	100	—	—	6AQ4
Class A Amplifier Vertical Deflection Amplifier	180	180	8.5	29†	3.0†	58,000\$	3,700	—	5,500	2.0	6AQ5
	250	250	12.5	45†	4.5†	52,000\$	4,100	—	5,000	4.5	
	250	—	12.5	49.5	—	1,970\$	4,800	9.5	—	—	6AQ5-A ¶
	Max positive pulse plate voltages: □ = 1100 v; max d-c cathode current = 35 ma										

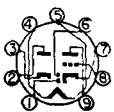

9E

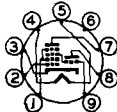

9O

- § Approximate.
- Without external shield.
- † Zero signal.
- ♦ Grids 3 and 5 are screen. Grid 4 is signal-input grid.
- # Conversion transconductance.
- ♣ Maximum.
- ♥ Grids 2 and 4 are screen. Grid 3 is signal-input grid.

- ♣ Screen supply voltage.
- Absolute maximum rating.
- † Plate-to-plate.
- ♣ Per section.
- ♦ Design maximum rating.
- ⊕ For both sections.
- \* Minimum.
- ¶ Heater warm-up time controlled for series-string service.
- ‡ Plate supply voltage.
- || Input plate.
- The duration of the pulse voltage must not exceed 15 percent of one scanning cycle.
- 1— Section 1.
- 2— Section 2.
- ⊖ A resistor of 3 ohms must be put in series with heater.

Tube Type	Classification by Construction	Base Connections	Out-line Dwg	Filament Volts	Filament Amp	Max Plate Watts	Max Plate Volts	Max Screen Volts	Capacitance in Micromicrofarads		
									Input	Out-put	Grid-plate
<i>6AQ6</i>	Duplex-Diode High-Mu Triode	7BT	5-2	6.3	0.15	—	300	—	1.7	1.5	1.8
<i>6AQ7-GT</i>	Duplex-Diode High-Mu Triode	8CK	9-11 or 9-41	6.3	0.3	1.0	250	—	—	—	—
<i>6AQ8</i>	Twin Triode	9DE	6-2	6.3	0.435	2.5♣	300	—	3.0▲	1.2▲	1.5▲
<i>6AR5</i>	Power Amplifier Pentode	6CC	5-3	6.3	0.4	8.5	250	250	—	—	—
<i>6AR6</i>	Beam Power Amplifier	6BQ	T-X	6.3	1.2	21☐	630	315	11.0▲	7.0▲	0.8▲♣
<i>6AR7-GT</i>	Twin-Diode, Remote-Cutoff Pentode	7DE	T-X	6.3	0.3	2.25	300	125	5.5▲	7.5▲	0.003▲♣
<i>6AR8</i>	Double Plate Sheet-Beam Tube	9DP	6-3	6.3	0.3	2.0♣	300	300	—	—	—
<i>6AS5</i>	Beam Power Amplifier	7CV	5-3	6.3	0.8	5.5	150	117	12▲	6.2▲	0.6▲
<i>6AS6</i>	Dual-Control RF Pentode	7CM	5-1	6.3	0.175	1.7	180	140	4.0	3.0	0.02♣
<i>6AS7-G</i> <i>6AS7-GA</i>	Low-Mu Twin Triode	8BD	16-3 T-X	6.3	2.5	13♣	250	—	—	—	—
<i>6AS8</i>	Diode Sharp-Cutoff RF Pentode	9DS	6-2	6.3	0.45	2.5	300	150	Pentode Section Diode Section		
<i>6AT6</i>	Duplex-Diode High-Mu Triode	7BT	5-2	6.3	0.3	0.5	300	—	2.2▲	0.8▲	2.0▲
<i>6AT8</i>	Triode-Pentode Converter	9DW	6-2	6.3	0.45	2.0 1.5	250 250	250* —	Pentode Section Triode Section		
<i>6AU4-GT</i> <i>6AU4-GTA</i>	Half-Wave High-Vacuum Rectifier Half-Wave High-Vacuum Rectifier	4CG 4CG	9-44 9-44	6.3 6.3	1.8 1.8	6.0 6.0	Tube Voltage Drop: 25 v at 350 ma d-c Tube Voltage Drop: 25 v at 350 ma d-c				
<i>6AU5-GT</i>	Beam Power Amplifier	6CK	9-11 or 9-41	6.3	1.25	10	550♣	200	11.3▲	7.0▲	0.5▲
<i>6AU6</i> <i>6AU6-A</i> ¶	Sharp-Cutoff RF Pentode	7BK	5-2	6.3	0.3	3.0 3.2	300 250	150 —	Pentode Connection Triode Connection (G <sub>2</sub> , G <sub>3</sub> , & P tied)		

Metal tubes are shown in bold-face type, miniature tubes in *italics*.

♣Subminiature type.

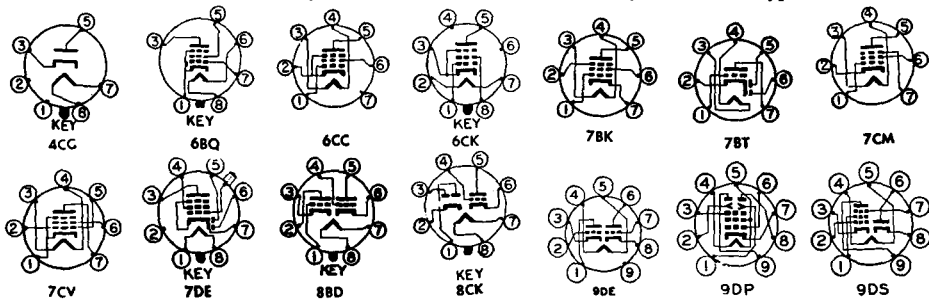

Service	Plate Volts	Screen Volts	Neg Grid Volts	Plate Milli-am-peres	Screen Milli-am-peres	R <sub>p</sub> , Ohms	G <sub>m</sub> , μmhos	μ Factor	Load for Rated Out-put, Ohms	Power Out-put, Watts	Tube Type
Class A Amplifier	250 100	—	3.0 1.0	1.0 0.8	—	58,000 61,000	1,200 1,150	70 70	—	—	6AQ6
Class A Amplifier	250 100	—	2.0 1.0	2.3 1.1	—	44,000§ 64,000§	1,600 1,250	70 79	—	—	6AQ7-GT
Class A Amplifier ♠	250	—	2.3	10	—	9,700§	5,900	57	—	—	6AQ8
Class A Amplifier	250 250	250 250	18 16.5	32† 34†	5.5† 5.7†	68,000 65,000	2,300 2,400	—	7,600 7,000	3.4 3.2	6AR5
Class A Amplifier	300	300	36.0	58	4.0	22,000	4,300	—	—	—	6AR6
Class A Amplifier	250	100	2.0	7.0	1.8	1,200,000	2,500	—	—	—	6AR7-GT
Color TV Synchronous Detector	250	250	R <sub>k</sub> = 300	10	0.4	—	4,000	—	—	—	6AR8
	[With plates tied together and deflectors (pins 1 and 2) grounded] Total voltage change on either deflector with an equal and opposite change on the other deflector required to switch the plate current from one plate to the other = 20 volts maximum.										
Class A Amplifier	150	110	8.5	35†	2.0†	—	5,600	—	4,500	2.2	6AS5
Class A Amplifier	120 120	120 120	2.0 2.0	5.2 3.6	3.5 4.8	110,000§ —	3,200 1,850	E <sub>cs</sub> = 0 volts E <sub>cs</sub> = -3 volts		—	6AS6
DC Amplifier ♠	135	—	R <sub>k</sub> = 250	125	—	280	7,000	2.0	—	—	6AS7-G 6AS7-GA
Class A Amplifier Detector	200	150	R <sub>k</sub> = 180	9.5	3.0	300,000§	6,200	—	—	—	6AS8
	Max d-c output current = 5 ma; max peak inverse voltage = 330 volts; max peak current = 50 ma										
Class A Amplifier	250 100	—	3.0 1.0	1.0 0.8	—	58,000 54,000	1,200 1,300	70 70	—	—	6AT6
Class A Amplifier Class A Amplifier	250 100	150 —	R <sub>k</sub> = 200 R <sub>k</sub> = 100	7.7 8.5	1.6 —	750,000§ 6,900§	4,600 5,800	— 40	— —	— —	6AT8
TV Damp-er Service TV Damp-er Service ‡	Max d-c output current = 175 ma; max peak inverse voltage ⊞ = 4,500 volts; max peak current = 1050 ma. Max d-c output current = 190 ma; max peak inverse voltage ⊞ = 4,500 volts; max peak current = 1,150 ma.										6AU4-GT 6AU4-GTA
Horizontal Deflection Amplifier	115 60	175 175	20 0	60 210	6.8 25	6,000§	5,600	—	—	—	6AU5-GT
	Max positive pulse plate voltage, ⊞ = 5500 v; max screen dissipation = 2.5 watts; max d-c cathode current = 110 ma										
Class A Amplifier	250	150	R <sub>k</sub> = 68	10.6	4.3	1,000,000§	5,200	—	—	—	6AU6 6AU6-A¶
Class A Amplifier	100	100	R <sub>k</sub> = 150	5.0	2.1	500,000§	3,900	—	—	—	
Class A Amplifier	250	—	R <sub>k</sub> = 330	12.2	—	—	4,800	36	—	—	

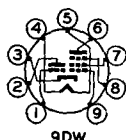

9DW

‡ Approximate.

▲ Without external shield.

† Zero signal.

‡ Grids 3 and 5 are screen. Grid 4 is signal-

input grid.

# Conversion transconductance.

♣ Maximum.

♦ Grids 2 and 4 are screen. Grid 3 is signal-

input grid.

⊞ Screen supply voltage.

⊞ Absolute maximum rating.

‡ Plate-to-plate.

♣ Per section.

♣ Design maximum rating.

⊞ For both sections.

\* Minimum.

¶ Heater warm-up time controlled for

series-string service.

‡ Plate supply voltage.

⊞ Input plate.

‡ The duration of the pulse voltage must not exceed 15 percent of one scanning cycle.

1—Section 1.

‡ Section 2.

‡ A resistor of 3 ohms must be put in series with heater.

Tube Type	Classification by Construction	Base Connections	Out-line Dwg	Filament Volts	Filament Amp	Max Plate Watts	Max Plate Volts	Max Screen Volts	Capacitance in Micromicrofarads		
									Input	Output	Grid-plate
<i>6AU8</i> ¶	Triode-Pentode	9DX	6-3	6.3	0.6	3.0 2.5	300 300	150 —	Pentode Section Triode Section		
<i>6AV4</i>	Full-Wave High-Vacuum Rectifier	5BS	5-3	6.3	0.95	—	—	—	—	—	—
<i>6AV5-GA</i>	Beam Power Amplifier	6CK	T-X	6.3	1.2	11	550‡	175	14▲	7.0▲	0.5▲
<i>6AV5-GT</i>	Beam Power Amplifier	6CK	9-11 or 9-41	6.3	1.2	11	550‡	175	14▲	7.0▲	0.7▲
<i>6AV6</i>	Duplex-Diode High-Mu Triode	7BT	5-2	6.3	0.3	0.5	300	—	2.2	1.2	2.0
<i>6AW7-GT</i>	Duplex-Diode, High-Mu Triode	8CQ	9-16	6.3	0.3	—	300	—	—	—	—
<i>6AW8</i> ¶	Triode-Pentode	9DX	6-3	6.3	0.6	3.25 1.0	300 300	150 —	Pentode Section Triode Section		
<i>6AW8-A</i> ¶	Triode-Pentode	9DX	6-3	6.3	0.6	3.25 1.0	300 300	150 —	Pentode Section Triode Section		
<i>6AX4-GT</i>	Half-Wave High-Vacuum Rectifier	4CG	9-11 or 9-41	6.3	1.2	4.8	Tube Voltage Drop: 32 v at 250 ma d-c				
<i>6AX5-GT</i>	Full-Wave High-Vacuum Rectifier	6S	9-41	6.3	1.2	—	Tube Voltage Drop: ♦ 50 v at 125 ma d-c				
<i>6AX6-G</i>	Full-Wave High-Vacuum Rectifier	7Q	14-3	6.3	2.5	—	Tube Voltage Drop: ♦ 21 v at 250 ma d-c				
<i>6AX7</i> ¶	High-Mu Twin Triode	9A	6-2	{6.3 3.15}	{0.3 0.6}	1.0♦	300	—	1.8	1.9	1.7
<i>6AX8</i>	Triode-Pentode	9AE	6-2	6.3	0.45	2.8 2.7	300 300	150 —	Pentode Section Triode Section		
<i>6AZ5</i> ⊙	Twin Diode	8DF	3-1	6.3	0.15	—	Tube Voltage Drop: ♦ 10 v at 15 ma d-c				
<i>6AZ6</i> ⊙	Twin Diode	8EH	T-X	6.3	0.15	—	Tube Voltage Drop: ♦ 3.5 v at 8 ma d-c				
<i>6AZ8</i>	Triode-Pentode	9ED	6-2	6.3	0.45	2.0 2.6	300 300	150 —	Pentode Section Triode Section		

Metal tubes are shown in bold-face type, miniature tubes in italics.

⊙Subminiature type.

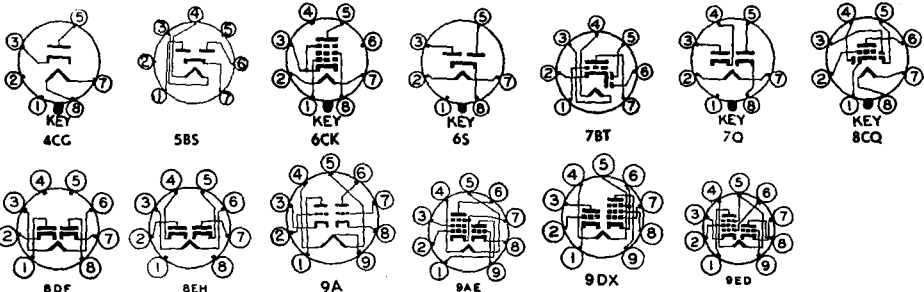

Service	Plate Volts	Screen Volts	Neg Grid Volts	Plate Milli-am-peres	Screen Milli-am-peres	R <sub>p</sub> , Ohms	G <sub>m</sub> , μmhos	μ Fac-tor	Load for Rated Out-put, Ohms	Power Out-put, Watts	Tube Type
Class A Amplifier Class A Amplifier	200	125	R <sub>k</sub> = 82	15	3.4	150,000§	7,000	—	—	—	6AU8¶
	150	—	R <sub>k</sub> = 150	9.0	—	8,200§	4,900	40	—	—	
Full-Wave Rectifier	Max d-c output current = 90 ma; max peak inverse voltage = 1,250 volts; max peak current per plate = 250 ma										6AV4
Horizontal Deflection Amplifier	250	150	22.5	57	2.1	14,500§	5,900	—	—	—	6AV5-GA
	60	150	0	260	26	—	—	—	—	—	
Horizontal Deflection Amplifier	250	150	22.5	55	2.1	20,000§	5,500	—	—	—	6AV5-GT
	60	150	0	225	25	—	—	—	—	—	
Max positive pulse plate voltage; ⊞ = 5,500 volts; max screen dissipation = 2.5 watts; max d-c cathode current = 110 ma											
Max positive pulse plate voltage; ⊞ = 5,500 v; max screen dissipation = 2.5 watts; max d-c cathode current = 110 ma											
Class A Amplifier	250	—	2.0	1.2	—	62,500§	1,600	100	—	—	6AV6
	100	—	1.0	0.5	—	80,000§	1,250	100	—	—	
Class A Amplifier	100	—	0	1.4	—	—	1,200	80	—	—	6AW7-GT
Class A Amplifier Class A Amplifier	200	150	R <sub>k</sub> = 180	13	3.5	400,000§	9,000	—	—	—	6AW8¶
	200	—	2.0	4.0	—	17,500§	4,000	70	—	—	
Class A Amplifier Class A Amplifier	200	150	R <sub>k</sub> = 180	13	3.5	400,000§	9,000	—	—	—	6AW8-A¶
	65	150	0	42	12.5	—	—	—	—	—	
Class A Amplifier	200	—	2.0	4.0	—	17,500§	4,000	70	—	—	
TV Damper Service	Max d-c output current = 125 ma; max peak inverse voltage ⊞ = 4400 volts; max peak current = 750 ma.										6AX4-GT
Full-Wave Rectifier	Max d-c output current = 125 ma; max peak inverse voltage = 1250 volts; rms supply voltage per plate = 350 volts; max peak current per plate = 375 ma										6AX5-GT
Full-Wave Rectifier TV Damper Service	Max d-c output current = 250 ma; max peak inverse voltage = 1250 volts; rms supply voltage per plate = 350 volts; max peak current per plate = 600 ma										6AX6-G
	Max d-c output current per plate = 125 ma; max peak inverse voltage = 2000 volts; max peak current per plate = 600 ma										
Class A Amplifier ♠	100	—	1.0	0.5	—	80,000§	1,250	100	—	—	6AX7¶
	250	—	2.0	1.2	—	62,500§	1,600	100	—	—	
Class A Amplifier Class A Amplifier	250	110	R <sub>k</sub> = 120	10	3.5	400,000§	4,800	—	—	—	6AX8
	150	—	R <sub>k</sub> = 56	18	—	5,000§	8,500	40	—	—	
Half-Wave Rectifier	Max d-c output current per plate = 4 ma; max peak inverse voltage = 420 volts; max rms supply voltage per plate = 150 volts; max peak current per plate = 24 ma										6AZ5 ⊙
Full-Wave Rectifier	Max d-c output current = 20 ma; max peak inverse voltage = 450 volts; max rms supply voltage per plate = 200 volts; max peak current per plate = 50 ma										6AZ6 ⊙
Class A Amplifier Class A Amplifier	200	150	R <sub>k</sub> = 180	9.5	3.0	300,000§	6,000	—	—	—	6AZ8
	200	—	6.0	13	—	5,750§	3,300	19	—	—	

§ Approximate.

▲ Without external shield.

† Zero signal.

‡ Grids 3 and 5 are screen. Grid 4 is signal-input grid.

# Conversion transconductance.

♣ Maximum.

♥ Grids 2 and 4 are screen. Grid 3 is signal-input grid.

✱ Screen supply voltage.

⊞ Absolute maximum rating.

‡ Plate-to-plate.

♠ Per section.

⊙ Design maximum rating.

⊕ For both sections.

\* Minimum.

¶ Heater warm-up time controlled for series-string service.

‡ Plate supply voltage.

|| Input plate.

♣—The duration of the pulse voltage must not exceed 15 percent of one scanning cycle.

1—Section 1.

2—Section 2.

4—A resistor of 3 ohms must be put in series with heater.

Tube Type	Classification by Construction	Base Connections	Out-line Dwg	Fila-ment Volts	Fila-ment Amp	Max Plate Watts	Max Plate Volts	Max Screen Volts	Capacitance in Micromicrofarads		
									Input	Out-put	Grid-plate
6B4-G	Power Amplifier Triode	5S	16-3	6.3	1.0	15	325	—	Single tube 2 tubes, Push-pull		
6B5	Direct-Coupled Power Amplifier Triode	6AS	14-1	6.3	0.8	13.5 2.5	300	300	—	—	—
6B6-G	Duplex Diode High-Mu Triode	7V	12-8	6.3	0.3	—	250	—	—	—	—
6B7	Duplex-Diode Remote-Cutoff Pentode	7D	12-6	6.3	0.3	2.25	300	125	3.5▲	9.5▲	.007♣
<b>6B8</b> 6B8-G 6B8-GT	Duplex Diode Remote-Cutoff Pentode	8E	8-4 12-8 9-20	6.3	0.3	3.0 2.25 3.0	300	125	6.0 3.6 4.5	9.0 9.5 10.0	.005♣ .01♣ 0.005♣
6BA4	High-Mu Planar Triode	—	T-X	6.3	0.4	2.0■	200	—	—	—	—
6BA5●	Sharp-Cutoff Pentode	8DY	3-1	6.3	0.15	0.7	150	140	3.4	3.6	0.065
<i>6BA6</i>	Remote-Cutoff RF Pentode	7BK	5-2	6.3	0.3	3.0	300	150	5.5	5.5	0.0035♣
<i>6BA7</i>	Pentagrid Converter	8CT ▼	6-3	6.3	0.3	2.0	300	100	Osc $I_{g1} = 0.35$ ma $R_{g1} = 20,000$ ohms		
<i>6BA8¶</i>	Triode-Pentode	9DX	6-3	6.3	0.6	3.25 2.0	300 300	150 —	Pentode Section Triode Section		
<i>6BA8-A¶</i>	Triode-Pentode	9DX	6-3	6.3	0.6	3.25 2.0	300 300	150 —	Pentode Section Triode Section		
<i>6BC4</i>	UHF Triode	9DR	6-1	6.3	0.225	2.5	250	—	2.9▲	0.26▲	1.6
<i>6BC6</i>	Sharp-Cutoff RF Pentode	7BD	5-2	6.3	0.3	2.0 2.5	300 300	150 —	Pentode Connection Triode Connection (G <sub>2</sub> & P tied)		
<i>6BC7</i>	Triple Diode	9AX	6-2	6.3	0.45	—	Avg Diode Current: (Diode 1 or 3 35 ma @ +5 v d-c)				
<i>6BC8</i>	High-Frequency Twin Triode	9AJ	6-2	6.3	0.4	2.0♣	250	—	2.5	1.3	1.4

Metal tubes are shown in bold-face type, miniature tubes in *italics*.

●Subminiature type.

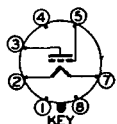

5S

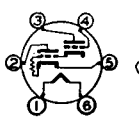

6AS

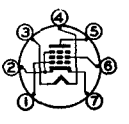

7BD



7BK

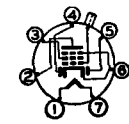

7D

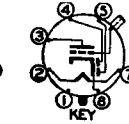

7V

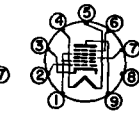

8CT



8DY

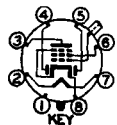

8E

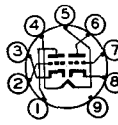

9AJ

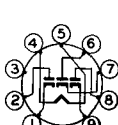

9AX



9DR

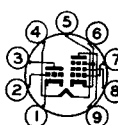

9DX



Service	Plate Volts	Screen Volts	Neg Grid Volts	Plate Milli-am-peres	Screen Milli-am-peres	$R_p$ , Ohms	$G_m$ , $\mu$ mhos	$\mu$ Fac-tor	Load for Rated Out-put, Ohms	Power Out-put, Watts	Tube Type
Class A Amplifier	250	—	45	60†	—	800	5,250	4.2	2,500	3.2	6B4-G
Class A B <sub>1</sub> Amplifier	325	—	68	80†	—	—	—	—	3,000‡	15.0	
Class A Amplifier	300	300	0	45	8.0	24,000§	2,400	—	7,000	4.0	6B5
Class A Amplifier	250	—	2.0	0.9	—	91,000	1,100	100	—	—	6B6-G
Class A Amplifier	250	125	3.0	9.0	2.3	600,000§	1,125	—	—	—	6B7
Class A Amplifier	250	125	3.0	10	2.3	600,000§	1,325	—	—	—	6B8 6B8-G 6B8-GT
Class A Amplifier	150	—	$R_k = 100$	10	—	8,700§	8,000	70	—	—	6BA4
Class A Amplifier	100	100	$R_k = 270$	5.5	2.0	175,000	2,150	—	—	—	6BA5⊙
Class A Amplifier	250	100	$R_k = 68$	11	4.2	1,000,000§	4,400	—	—	—	6BA6
	100	100	$R_k = 68$	10.8	4.4	250,000§	4,300	—	—	—	
Converter	250	100	1.0	3.8	10.0	1,000,000§	950 #	—	—	—	6BA7
Class A Amplifier Class A Amplifier	200	150	$R_k = 180$	13	3.5	400,000§	9,000	—	—	—	6BA8¶
	200	—	8.0	8.0	—	6,700§	2,700	18	—	—	
Class A Amplifier Class A Amplifier	200	150	$R_k = 180$	13	3.5	400,000§	9,000	—	—	—	6BA8-A¶
	65 200	150 —	0 8.0	42 8.0	12.5 —	— 6,700§	— 2,700	— 18	— —	— —	
Class A Amplifier	150	—	$R_k = 100$	14.5	—	4,800	10,000	48	—	—	6BC4
Class A Amplifier	250	150	$R_k = 180$	7.5	2.1	800,000§	5,700	—	—	—	6BC5
	125	125	$R_k = 100$	8.0	2.4	500,000§	6,100	—	—	—	
	100	100	$R_k = 180$	4.7	1.4	600,000§	4,900	—	—	—	
Class A Amplifier	250	—	$R_k = 820$	6.0	—	9,000§	4,400	40	—	—	
	180	—	$R_k = 330$	8.0	—	6,000§	6,000	42	—	—	
Half-Wave Rectifier	Max d-c output current per plate = 12 ma										6BC7
Class A Amplifier ♦	150	—	$R_k = 220$	10	—	5,650§	6,200	35	—	—	6BC8

§ Approximate.

▲ Without external shield.

† Zero signal.

♦ Grids 3 and 5 are screen. Grid 4 is signal-

input grid.

# Conversion transconductance.

◆ Maximum.

▼ Grids 2 and 4 are screen. Grid 3 is signal-

input grid.

\* Screen supply voltage.

⊙ Absolute maximum rating.

† Plate-to-plate.

◆ Per section.

◆ Design maximum rating.

⊙ For both sections.

\* Minimum.

¶ Heater warm-up time controlled for series-string service.

§ Plate supply voltage.

|| Input plate.

‡ The duration of the pulse voltage must not exceed 15 percent of one scanning cycle.

1—Section 1.

2—Section 2.

⚡ A resistor of 3 ohms must be put in series with heater.

Tube Type	Classification by Construction	Base Connections	Out-line Dwg	Filament Volts	Filament Amp	Max Plate Watts	Max Plate Volts	Max Screen Volts	Capacitance in Microfarads		
									Input	Output	Grid-plate
<b>6BD4</b>	Sharp-Cutoff Beam Triode	8FU	T-X	6.3	0.6	20	20,000	—	3.8▲	0.04♣	1.0▲
<b>6BD4-A</b>	Sharp-Cutoff Beam Triode	8FU	T-X	6.3	0.6	25	27,000	—	3.8▲	0.04♣	1.0▲
<b>6BD5-GT</b>	Beam Power Amplifier	6CK	T-X	6.3	0.9	10	325	325	—	—	—
<i>6BD6</i>	Remote-Cutoff RF Pentode	7BK	5-2	6.3	0.3	3.0	300	125	4.3	5.0	0.005♣
<i>6BD7</i>	Duplex-Diode, High-Mu Triode	9Z	6-3	6.3	0.23	0.5	300	—	—	—	—
<i>6BE6</i>	Pentagrid Converter	7CH ♥	5-2	6.3	0.3	1.0	300	100	Osc $I_{g1} = 0.5$ ma $R_{g1} = 20,000$ ohms		
<i>6BE7</i>	Seven-Grid Limiter-Discriminator	9AA	6-3	6.3	0.2	0.1	250	100	$E_{c3} = 12$ volts RMS $E_{c5} = 12$ volts RMS		
<i>6BE8</i>	Triode-Pentode	9EG	6-2	6.3	0.45	2.8	300	150	Pentode Section		
						2.5	300	—	Triode Section		
<b>6BF5</b>	Beam Power Amplifier	7BZ	5-3	6.3	1.2	5.5	250	117	Pentode Connection		
						5.0	250	—	Triode Connection ( $G_2$ & P tied)		
<b>6BF6</b>	Duplex-Diode Medium-Mu Triode	7BT	5-2	6.3	0.3	2.5	300	—	1.8	1.4	2.0
<b>6BF7</b> Ⓞ	Medium-Mu Twin Triode	8DG	3-2	6.3	0.3	1.0♣	110	—	2.0	1.6 <sub>1</sub> 2.0 <sub>2</sub>	1.5
<b>6BF7-A</b> Ⓞ	Medium-Mu Twin Triode	8DG	3-2	6.3	0.3	1.1♣ Ⓞ	120Ⓞ	—	2.0	1.6 <sub>1</sub> 2.0 <sub>2</sub>	1.5
<b>6BG6-G</b> <b>6BG6-GA</b>	Beam Power Amplifier	5BT	16-5 T-X	6.3	0.9	20	700♣	350	12▲	6.5▲	0.34▲
<b>6BG7</b> Ⓞ	Medium-Mu Twin Triode	8DG	3-5	6.3	0.3	1.0♣	110	—	2.0	1.6 <sub>1</sub> 2.0 <sub>2</sub>	1.5
<b>6BH5</b>	Remote-Cutoff RF Pentode	9AZ	6-3	6.3	0.2	2.0	300	125	—	—	—
<b>6BH6</b>	Sharp-Cutoff RF Pentode	7CM	5-2	6.3	0.15	3.0	300	150	5.4	4.4	0.0035♣
<b>6BH8</b> ¶	Triode-Pentode	9DX	6-3	6.3	0.6	3.0	300	150	Pentode Section		
						2.5	300	—	Triode Section		
<b>6BJ6</b>	Power Amplifier Pentode	6CH	T-X	6.3	0.64	9.0	350	275	—	—	—

Metal tubes are shown in bold-face type, miniature tubes in italics. ⓄSubminiature type.

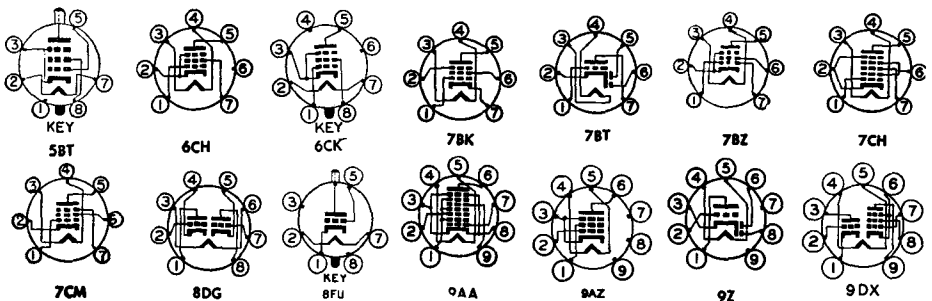

Service	Plate Volts	Screen Volts	Neg Grid Volts	Plate Milli-am-peres	Screen Milli-am-peres	R <sub>p</sub> , Ohms	G <sub>m</sub> , μmhos	μ Factor	Load for Rated Out-put, Ohms	Power Out-put, Watts	Tube Type
High-Voltage Shunt Regulator	Max unregulated d-c supply voltage = 40,000 volts; max d-c plate current = 1.5 ma										6BD4
High-Voltage Shunt Regulator	Max unregulated d-c supply voltage = 55,000 volts; max d-c plate current = 1.5 ma										6BD4-A
Horizontal Deflection Amplifier	Max positive pulse plate voltage <sub>1</sub> = 4,000 volts; max screen dissipation = 3.0 watts; max d-c cathode current = 100 ma										6BD5-GT
Class A Amplifier	250 100	100 100	3.0 1.0	9 13	3 5	800,000 150,000	2,000 2,550	—	—	—	6BD6
Class A Amplifier	250	—	3.0	1.0	—	58,000	1,200	70	—	—	6BD7
Converter	250 100	100 100	1.5 1.5	2.9 2.6	6.8 7.0	1,000,000 400,000	475 # 455 #	—	—	—	6BE6
FM Limiter-Discriminator	250§	20§	4.4§	0.28	1.5	5,000,000	—	—	470000	—	6BE7
Class A Amplifier	250	110	R <sub>k</sub> = 68	10	3.5	400,000§	5,200	—	—	—	6BE8
Class A Amplifier	150	—	R <sub>k</sub> = 56	18	—	5,000§	8,500	40	—	—	6BE8
Class A Amplifier	110	110	7.5	36†	4†	12,000§	7,500	—	2,500	1.9	6BF5
Vertical Deflection Amplifier	225	—	30	10	—	2,500	2,700	6.7	—	—	6BF5
Max positive pulse plate voltage <sub>2</sub> □ = 900 volts; max d-c cathode current = 40 ma											
Class A Amplifier	250	—	9.0	9.5	—	8,500	1,900	16	—	—	6BF6
Class A Amplifier ♣	100	—	R <sub>k</sub> = 100	8.0	—	7,000	4,800	35	—	—	6BF7 ●
Class A Amplifier ♣	100	—	R <sub>k</sub> = 100	8.0	—	7,300§	4,800	35	—	—	6BF7-A ●
Horizontal Deflection Amplifier	250 60	250 250	15 0	75 180	4.0 18	25,000§ —	6,000 —	—	—	—	6BG6-G 6BG6-GA
Max positive pulse plate voltage <sub>3</sub> □ = 6600 volts; max screen dissipation = 3.2 watts; max d-c cathode current = 110 ma											
Class A Amplifier ♣	100	—	R <sub>k</sub> = 100	8.0	—	7,000	4,800	35	—	—	6BG7 ●
Class A Amplifier	250	100§	2.5	6.0	1.7	1,100,000	2,200	—	—	—	6BH5
Class A Amplifier	100 250	100 150	1.0 1.0	3.6 7.4	1.4 2.9	700,000§ 1,400,000§	3,400 4,600	—	—	—	6BH6
Class A Amplifier	200	125	R <sub>k</sub> = 82	15	3.4	150,000§	7,000	—	—	—	6BH8 ¶
Class A Amplifier	150	—	5.0	9.5	—	5,150§	3,300	17	—	—	6BH8 ¶
Class A Amplifier	250	250	5.0	35	5.5	40,000	10,500	—	7,000	4	6BJ5

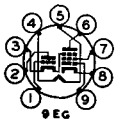

§ Approximate.  
 ▲ Without external shield.  
 † Zero signal.  
 ♦ Grids 3 and 5 are screen. Grid 4 is signal-input grid.  
 # Conversion transconductance.  
 ♣ Maximum.  
 ♥ Grids 2 and 4 are screen. Grid 3 is signal-input grid.  
 ✖ Screen supply voltage.  
 □ Absolute maximum rating.  
 ‡ Plate-to-plate.  
 ♠ Per section.  
 ◇ Design maximum rating.

⊕ For both sections.  
 \* Minimum.  
 ¶ Heater warm-up time controlled for series-string service.  
 § Plate supply voltage.  
 || Input plate.  
 †—The duration of the pulse voltage must not exceed 15 percent of one scanning cycle.  
 1—Section 1.  
 2—Section 2.  
 4—A resistor of 3 ohms must be put in series with heater.

Tube Type	Classification by Construction	Base Connections	Out-line Dwg	Fila-ment Volts	Fila-ment Amp	Max Plate Watts	Max Plate Volts	Max Screen Volts	Capacitance in Micromicrofarads		
									Input	Out-put	Grid-plate
<i>6BJ6</i>	Remote-Cutoff R-F Pentode	7CM	5-2	6.3	0.15	3.0	300	150	4.5	5.5	0.0035 ♣
<i>6BJ7</i>	Triple Diode	9AX	6-2	6.3	0.45	—	Tube Voltage Drop: ♣ 2.7 v at 10 ma d-c				
<i>6BJ8</i> ¶	Duplex-Diode Triode	9ER	6-3	6.3	0.6	3.5	300	—	2.8 ▲	0.38 ▲	2.6 ▲
									Diode Sections		
<i>6BK4</i>	Sharp-Cutoff Beam Triode	8GC	T-X	6.3	0.2	25	25,000	—	2.6 ▲	1.0 ▲	0.03 ▲
<i>6BK5</i>	Beam Power Amplifier	9BQ	6-3	6.3	1.2	9.0	250	250	13 ▲	5.0 ▲	0.6 ▲
<i>6BK6</i>	Duplex-Diode High- $\mu$ Triode	7BT	5-3	6.3	0.3	—	300	—	—	—	—
<i>6BK7</i>	High-Frequency Twin Triode	9AJ	6-2	6.3	0.45	2.7 ♣	300	—	3.0 ▲	1.1 <sub>1</sub> ▲ 1.0 <sub>2</sub> ▲	1.9 ▲
<i>6BK7-A</i> <i>6BK7-B</i> ¶	High-Frequency Twin Triode	9AJ	6-2	6.3	0.45	2.7 ♣	300	—	3.0 ▲	1.0 <sub>1</sub> ▲ 0.9 <sub>2</sub> ▲	1.8 ▲
<i>6BK8</i>	Sharp-Cutoff AF Pentode	9BJ	6-2	6.3	0.2	—	300	200	4.0 ▲	5.5 ▲	0.025 ▲
<i>6BL4</i>	Half-Wave High-Vacuum Rectifier	8GB	T-X	6.3	3.0	8.0	Tube Voltage Drop: 20 v at 400 ma d-c				
<i>6BL7-GT</i>	Medium- $\mu$ Twin Triode	8BD	9-41	6.3	1.5	10 ♣ 12 ⊕	500	—	4.21 ▲ 4.62 ▲	0.9 ▲	6.0 ▲
<i>6BM5</i>	Power Amplifier Pentode	7BZ	5-3	6.3	0.45	9.0	250	250	8.0 ▲	5.5 ▲	0.5 ♣
<i>6BN4</i>	High-Frequency Triode	7EG	5-2	6.3	0.2	2.2 ⊕	275 ⊕	—	3.2	1.4	1.2
<i>6BN5</i>	Power Amplifier Pentode	9CR	6-3	6.3	0.2	6.0	300	300	4.3 ▲	5.1 ▲	0.2 ♣
<i>6BN6</i>	Gated-Beam Discriminator	7DF	5-3	6.3	0.3	—	300 ‡	100	$E_c1 = 1.25$ volts RMS* ▲		
<i>6BN7</i>	Double Triode	9BT	6-3	6.3	0.75	7.5 <sub>1</sub> 1.5 <sub>2</sub>	400 400	—	Section 1 (Pins 6, 7, 9)  Section 2 (Pins 1, 2, 3)		

Metal tubes are shown in bold-face type, miniature tubes in italics.

⊕ Subminiature type.

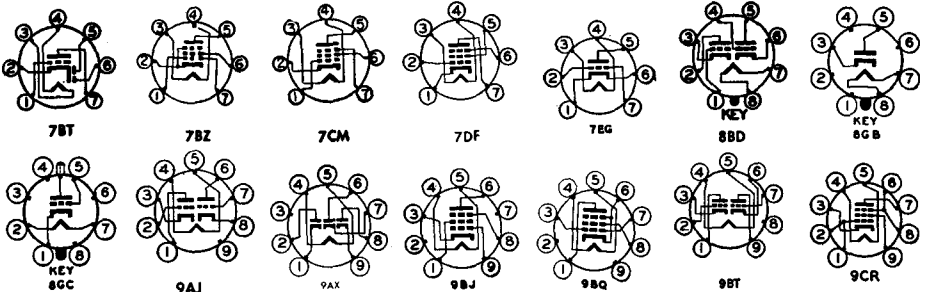

Service	Plate Volts	Screen Volts	Neg Grid Volts	Plate Milli-am-peres	Screen Milli-am-peres	R <sub>p</sub> , Ohms	G <sub>m</sub> , μmhos	μ Factor	Load for Rated Out-put, Ohms	Power Out-put, Watts	Tube Type
Class A Amplifier	250 100	100 100	1.0 1.0	9.2 9.0	3.3 3.5	1,300,000§ 250,000§	3,600 3,650	— —	— —	— —	6BJ6
DC Restorer	Max d-c output current per plate = 1.0 ma; max peak inverse voltage = 330 volts; max peak current per plate = 10 ma										6BJ7
Class A Amplifier	250 90	— —	9.0 0	8.0 13.5	— —	7,150§ 4,700§	2,800 4,700	20 22	— —	— —	6BJ8¶
Vertical Deflection Amplifier	Max positive pulse plate voltage ⊠ = 1,200 volts; max d-c cathode current = 20 ma										
Horizontal Phase Detector	Max d-c output current ♣ = 9.0 ma; voltage drop ♣: 2.6 volts at 9.0 ma d-c										
High-Voltage Shunt Regulator	Max unregulated d-c supply voltage = 55,000 volts; max d-c plate current = 1.5 ma; amplification factor = 2,000§										6BK4
Class A Amplifier	250	250	5.0	35†	3.5†	100,000§	8,500	—	6,500	3.5	6BK5
Class A Amplifier	250 100	— —	2.0 1.0	1.2 0.5	— —	62,500 80,000	1,600 1,250	100 100	— —	— —	6BK6
Class A Amplifier ♣	150 100	— —	R <sub>k</sub> = 56 R <sub>k</sub> = 120	18 9.0	— —	4,700§ 6,100§	8,500 6,100	40 37	— —	— —	6BK7
Class A Amplifier ♣	150	—	R <sub>k</sub> = 56	18	—	4,600§	9,300	43	—	—	6BK7-A 6BK7-B¶
Class A Amplifier	250	140	—	3.0	—	2,000,000	1,850	—	—	—	6BK8
TV Damper Service <sub>2</sub>	Max d-c output current = 200 ma; max peak inverse voltage ⊠ = 4500 volts; max peak current = 1200										6BL4
Vertical Deflection Amplifier ♣	250 250	— —	9.0 17	40 4.0	— —	2,150§	7,000	15	— —	— —	6BL7-GT
	Max positive pulse plate voltage ⊠ = 2,000 volts; max d-c cathode current = 60 ma										
Class A Amplifier	250	250	6.0	30†	3.0†	60,000§	7,000	—	7,000	3.5	6BM6
Class A Amplifier	150	—	R <sub>k</sub> = 220	9.0	—	6,300§	6,800	43	—	—	6BN4
Class A Amplifier	225	225	R <sub>k</sub> = 360	26†	4.1†	—	3,200	—	9,000	2.8	6BN5
FM Limiter-Discriminator	285§	100	R <sub>k</sub> = 200 to 400	0.49	9.8	—	—	—	330000	—	6BN6
Vertical Deflection Amplifier	250	—	15.0	24	—	2,200	5,500	12	—	—	6BN7
Class A Amplifier	120	—	1.0	5	—	14,000	2,000	28	—	—	

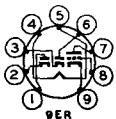

§ Approximate.  
 ▲ Without external shield.  
 † Zero signal.  
 ♣ Grids 3 and 5 are screen. Grid 4 is signal-input grid.  
 # Conversion transconductance.  
 ♣ Maximum.  
 ♠ Grids 2 and 4 are screen. Grid 3 is signal-input grid.  
 \* Screen supply voltage.  
 ⊠ Absolute maximum rating.  
 ‡ Plate-to-plate.  
 † Per section.  
 Ⓢ Design maximum rating.

Ⓢ For both sections.  
 \* Minimum.  
 † Heater warm-up time controlled for series-string service.  
 ‡ Plate supply voltage.  
 † Input plate.  
 ‡—The duration of the pulse voltage must not exceed 15 percent of one scanning cycle.  
 1—Section 1.  
 2—Section 2.  
 †—A resistor of 3 ohms must be put in series with heater.

Tube Type	Classification by Construction	Base Connections	Out-line Dwg	Fila-ment Volts	Fila-ment Amp	Max Plate Watts	Max Plate Volts	Max Screen Volts	Capacitance in Micromicrofarads		
									Input	Out-put	Grid-plate
<b>6BN8</b>	Duplex-Diode High-mu Triode	9ER	6-3	6.3	0.6	1.5	300	—	3.6▲	0.32▲	2.5▲
<i>6BQ5</i>	Beam Power Amplifier	9CV	6-4	6.3	0.76	12	300	300	—	—	—
<b>6BQ6-G</b> <b>6BQ6-GTA</b>	Beam Power Amplifier	6AM	12-8 9-49 or 9-50	6.3	1.2	11	600	175	—	—	—
<b>6BQ6-GA</b> <b>6BQ6-GTB</b>	Beam Power Amplifier	6AM	T-X 9-49 or 9-50	6.3	1.2	11	600	200	15▲	7.0▲	0.6▲
<b>6BQ6-GT</b>	Beam Power Amplifier	6AM	9-49 or 9-50	6.3	1.2	11	550	175	15▲	7.5▲	0.6▲
<i>6BQ7</i>	High-Frequency Twin Triode	9AJ	6-2	6.3	0.4	2.0♣	250	—	2.85 <sub>1</sub>	1.35 <sub>1</sub>	1.15
<i>6BQ7-A</i>	High-Frequency Twin Triode	9AJ	6-2	6.3	0.4	2.0♣	250	—	2.6 <sub>1</sub>	1.2 <sub>1</sub>	1.2
<b>6BR7</b>	Sharp-Cutoff RF Pentode	9BC	6-2	6.3	0.15	1.75	300	125	4.25▲	4.0▲	0.01♣▲
<b>6BR8</b>	Triode-Pentode	9FA	6-2	6.3	0.45	2.8 2.7	300 300	150 —	Pentode Section Triode Section		
<i>6BS5</i>	Beam Power Amplifier	9DK	6-3	6.3	0.75	12.5	250	250	9.5▲	4.5▲	0.3♣▲
<i>6BS7</i>	Sharp-Cutoff RF Pentode	9BB	6-6	6.3	0.15	0.75	300	125	4.0▲	4.0▲	0.01♣▲
<i>6BS8</i>	Medium-mu Twin Triode	9AJ	6-2	6.3	0.4	2.0♣	150	—	2.6 <sub>1</sub>	1.2 <sub>1</sub>	1.15
<b>6BT4</b>	Full-Wave High-Vacuum Rectifier	8HA	T-X	6.3	0.6	—	—	—	—	—	—
<b>6BT6</b>	Duplex-Diode, High-Mu Triode	7BT	5-3	6.3	0.3	—	300	—	—	—	—
<b>6BT8</b>	Duplex-Diode Pentode	9FE	6-2	6.3	0.45	2.0	300	150	7.0▲	2.3▲	0.04♣▲
<b>6BU4</b>	Sharp-Cutoff Beam Triode	8GC	T-X	6.3	0.45	25	25,000	—	—	—	—
<b>6BU5</b>	Sharp-Cutoff Beam Pentode	6BU5	T-X	6.3	0.15	20	20,000	100	3.0▲	0.9▲	0.024▲

Metal tubes are shown in bold-face type, miniature tubes in italics. ©Subminiature type.

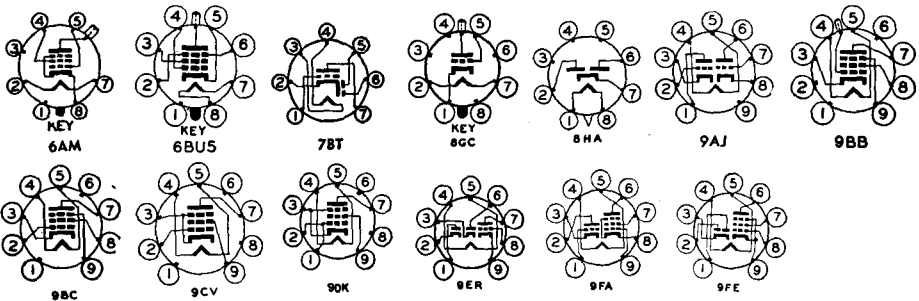

Service	Plate Volts	Screen Volts	Neg Grid Volts	Plate Milli-am-peres	Screen Milli-am-peres	R <sub>p</sub> , Ohms	G <sub>m</sub> , μmhos	μ Factor	Load for Rated Out-put, Ohms	Power Out-put, Watts	Tube Type
Class A Amplifier Horizontal Phase Detector	250	—	3.0	1.6	—	28,000§	2,500	70	—	—	6BN8¶
	100	—	1.0	1.5	—	21,000§	3,500	75	—	—	
Max d-c output current ♣ = 9.0 ma; voltage drop: ♣ 2.6 volts at 9.0 ma d-c											
Class A Amplifier	250	250	R <sub>k</sub> = 135	48†	5.5†	38,000	11,300	—	5200	6.0	6BQ6
Horizontal Deflection Amplifier	250	150	22.5	55	2.1	20,000§	5,500	—	—	—	6BQ6-G 6BQ6-GTA
	60	150	0	225	25	—	—	—	—	—	
Max positive pulse plate voltage: □ = 6000 volts; max screen dissipation = 2.5 watts; max d-c cathode current = 110 ma											
Horizontal Deflection Amplifier	250	150	22.5	57	2.1	14,500§	5,900	—	—	—	6BQ6-GA 6BQ6-GTB
	60	150	0	260	26	—	—	—	—	—	
Max positive pulse plate voltage: □ = 6,000 volts; max screen dissipation = 2.5 watts; max d-c cathode current = 110 ma											
Horizontal Deflection Amplifier	250	150	22.5	55	2.1	20,000§	5,550	—	—	—	6BQ6-GT
	60	150	0	225	25	—	—	—	—	—	
Max positive pulse plate voltage: □ = 5500 volts; max screen dissipation = 2.5 watts; max d-c cathode current = 110 ma											
Class A Amplifier ♣	150	—	R <sub>k</sub> = 220	9	—	5,800§	6,000	35	—	—	6BQ7
Class A Amplifier ♣	150	—	R <sub>k</sub> = 220	9.0	—	5,900§	6,400	38	—	—	6BQ7-A
Class A Amplifier	250	100	3.0	2.1	0.6	2,500,000	1,250	—	—	—	6BR7
Class A Amplifier Class A Amplifier	250	110	R <sub>k</sub> = 68	10	3.5	400,000§	5,200	—	—	—	6BR8
	150	—	R <sub>k</sub> = 56	18	—	5,000§	8,500	40	—	—	
Class A Amplifier	250	250	7.5	50†	6.0†	17,000§	7,000	—	5,000	4.5	6BS5
Class A Amplifier	250	100	3.0	2.1	0.6	2,400,000	1,250	—	—	—	6BS7
Class A Amplifier ♣	150	—	R <sub>k</sub> = 220	10	—	5,000	7,200	36	—	—	6BS8
Full-Wave Rectifier	Max d-c output current = 90 ma; max rms supply voltage per plate = 350 volts										6BT4
Class A Amplifier	250	—	3.0	1.0	—	58,000	1,200	70	—	—	6BT6
	100	—	1.0	0.8	—	54,000	1,300	70	—	—	
Class A Amplifier Horizontal Phase Detector	200	150	R <sub>k</sub> = 180	9.5	2.8	300,000§	6,200	—	—	—	6BT8
	Max d-c output current ♣ = 1.0 ma; voltage drop ♣: 10 volts at 8.0 ma d-c										
High-Voltage Shunt Regulator	Max unregulated d-c supply voltage = 55,000 volts; max d-c cathode current = 10 ma										6BU4
High-Voltage Shunt Regulator	20,000	70	2.4	1.0	0.4	—	—	—	E <sub>cs</sub> = 0 volts	—	6BU5
Max screen dissipation = 0.1 watt; max d-c cathode current = 2.5 ma											

- § Approximate.
- ▲ Without external shield.
- † Zero signal.
- ◆ Grids 3 and 5 are screen. Grid 4 is signal-input grid.
- # Conversion transconductance.
- ♣ Maximum.
- ♥ Grids 2 and 4 are screen. Grid 3 is signal-input grid.
- ✱ Screen supply voltage.
- Absolute maximum rating.
- ‡ Plate-to-plate.
- ♠ Per section.
- ◆ Design maximum rating.

- ⊙ For both sections.
- \* Minimum.
- ¶ Heater warm-up time controlled for series-string service.
- ‡ Plate supply voltage.
- || Input plate.
- §—The duration of the pulse voltage must not exceed 15 percent of one scanning cycle.
- 1—Section 1.
- 2—Section 2.
- ⊕—A resistor of 3 ohms must be put in series with heater.

Tube Type	Classification by Construction	Base Connections	Out-line Dwg	Fila-ment Volts	Fila-ment Amp	Max Plate Watts	Max Plate Volts	Max Screen Volts	Capacitance in Micromicrofarads		
									Input	Out-put	Grid-plate
<b>6BU6</b>	Duplex-Diode Medium-Mu Triode	7BT	5-3	6.3	0.3	—	300	—	—	—	—
<b>6BU8</b>	Twin Pentode	9FG	6-3	6.3	0.3	1.1 ⬥ ⬆	300 ⬥	150 ⬥	—	—	—
<b>6BV7</b>	Duplex-Diode Power Amplifier Pentode	9BU	6-3	6.3	0.8	10	250	250	11.5 ▲	9.5 ▲	0.5 ▲
<b>6BV8</b> ¶	Duplex-Diode Triode	9FJ	6-2	6.3	0.6	2.7 ⬥	330 ⬥	—	3.6	0.4	2.0
									Diode Sections		
<b>6BW4</b>	Full-Wave High-Vacuum Rectifier	9DJ	6-3	6.3	0.9	—	Tube Voltage Drop: ⬆ 40 v at 100 ma d-c				
<b>6BW6</b>	Beam Power Amplifier	9AM	6-3	6.3	0.45	12	315	285	—	—	—
<b>6BW7</b>	Sharp-Cutoff RF Pentode	9AQ	6-2	6.3	0.3	2.75	275	275	10 ▲	3.5 ▲	0.01 ⬆ ▲
<b>6BX4</b>	Full-Wave High-Vacuum Rectifier	5BS	5-3	6.3	0.6	—	—	—	—	—	—
<b>6BX6</b>	RF Pentode	9AQ	6-3	6.3	0.3	2.5	250	250	—	—	—
<b>6BX7-GT</b>	Medium-Mu Twin Triode	8BD	9-41	6.3	1.5	10 ⬆ 12 ⊕	500	—	4.4 <sub>1</sub> ▲ 4.8 <sub>2</sub> ▲	1.1 <sub>1</sub> ▲ 1.2 <sub>2</sub> ▲	4.2 <sub>1</sub> ▲ 4.0 <sub>2</sub> ▲
<b>6BX8</b>	High-Frequency Twin Triode	9AJ	6-2	6.3	0.4	2.0 ⬥ ⬆	150 ⬥	—	2.4 <sub>2</sub>	1.25 <sub>2</sub>	1.4
<b>6BY4</b>	High-mu Triode	6BY4	T-X	6.3	0.2	1.1 ⬥	300 ⬥	—	—	—	—
<b>6BY5-G</b>	Full-Wave High-Vacuum Rectifier	6CN	14-3	6.3	1.6	—	Tube Voltage Drop: ⬆ 32 volts at 175 ma d-c				
<b>6BY5-GA</b>	Full-Wave High-Vacuum Rectifier	6CN	T-X	6.3	1.6	—	Tube Voltage Drop: ⬆ 32 volts at 175 ma d-c				
<b>6BY6</b>	Dual-Control Heptode	7CH	5-2	6.3	0.3	2.0	300	150	—	—	—
<b>6BY7</b>	Remote-Cutoff RF Pentode	9AQ	6-3	6.3	0.3	2.5	250	250	7.2 ▲	3.7 ▲	0.007 ⬆▲

Metal tubes are shown in bold-face type, miniature tubes in italics.

⊕ Subminiature type.

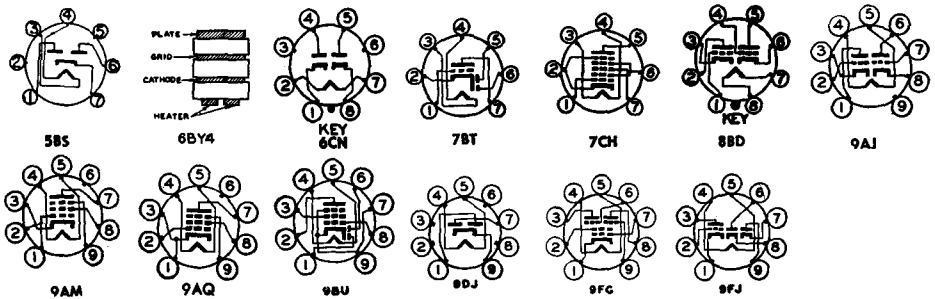



Service	Plate Volts	Screen Volts	Neg Grid Volts	Plate Milli-amperes	Screen Milli-amperes	R <sub>p</sub> , Ohms	G <sub>m</sub> , μmhos	μ Factor	Load for Rated Output, Ohms	Power Output, Watts	Tube Type
Class A Amplifier	250	—	9.0	9.5	—	8,500	1,900	16	10,000	0.30	6BU6
Sync Separator and AGC Keyer	100 100	67.5 67.5	I <sub>c1</sub> = 0.1 ma 0	2.2 —	5.0§ —	— —	— 1,500	— —	E <sub>c3</sub> = 0 volts E <sub>c3</sub> = 0 volts		6BU8
(Characteristics given are for each section separately with plate and grid number 3 of opposite section grounded)											
Class A Amplifier	250	250	5.0	38†	6.0†	100,000§	10,000	—	8,000	4.0	6BV7
Class A Amplifier { Synchronous Detector	200 75	— —	R <sub>k</sub> = 330 0	11 14	— —	5,900§	5,600	33	— —	— —	6BV8¶
Max d-c output current ♣ = 10 ma; voltage drop ♣: 5.0 volts at 23 ma d-c											
Full-Wave Rectifier	Max d-c output current = 100 ma; max peak inverse voltage = 1,275 volts; rms supply voltage per plate = 325 volts; max peak current per plate = 350 ma										6BW4
Class A Amplifier	315 250 180	225 250 180	13.0 12.5 8.5	34† 45† 29†	2.2† 4.5† 3†	77,000§ 52,000§ 58,000§	3,750 4,100 3,700	— — —	8,500 5,000 5,500	5.5 4.5 2.0	6BW6
Class A Amplifier	250	250	R <sub>k</sub> = 180	10	3.7	750,000	8,200	—	—	—	6BW7
Full-Wave Rectifier	Max d-c output current = 90 ma; max peak inverse voltage = 1350 volts; rms supply voltage per plate = 350 volts; max peak current per plate = 270 ma										6BX4
Class A Amplifier	170	170	2.0	10	2.5	400,000	7,200	—	—	—	6BX6
Vertical Deflection Amplifier ♣	250 100	— —	R <sub>k</sub> = 390 0	42 80	— —	1,300§	7,600	10	— —	— —	6BX7-GT
Max positive pulse plate voltages ⊞ = 2000 volts; max d-c cathode current = 60 ma											
Class A Amplifier ♣	65	—	1.0	9.0	—	3,750§	6,700	25	—	—	6BX8
Class A Amplifier	200	—	R <sub>k</sub> = 200	5.0	—	16,700§	6,000	100	—	—	6BY4
Full-Wave Rectifier { TV Damp-er Services	Max d-c output current = 175 ma; max peak inverse voltage = 1400 volts; rms supply voltage per plate = 375 volts; max peak current per plate = 525 ma; Max d-c output current = 175 ma; max peak inverse voltage = 3000 volts; max peak current per plate = 525 ma										6BY5-G
Full-Wave Rectifier { TV Damp-er Services	Max d-c output current = 175 ma; max peak inverse voltage ⊞ = 1400 volts; max peak current per plate = 525 ma Max d-c output current = 175 ma; max peak inverse voltage ⊞ = 3000 volts; max peak current per plate = 525 ma										6BY5-GA
Gated Amplifier	250 10	100 25	2.5 0	6.5 1.4	9 3.5	— —	1,900 —	E <sub>c3</sub> = -2.5 volts E <sub>c3</sub> = 0 volts	— —	— —	6BY6
Class A Amplifier	250	100	2.0	10	2.5	500,000	6,000	—	—	—	6BY7

§ Approximate.

▲ Without external shield.

† Zero signal.

♦ Grids 3 and 5 are screen. Grid 4 is signal-

input grid.

# Conversion transconductance.

♣ Maximum.

♥ Grids 2 and 4 are screen. Grid 3 is signal-

input grid.

✱ Screen supply voltage.

⊞ Absolute maximum rating.

‡ Plate-to-plate.

♣ Per section.

⊙ Design maximum rating.

⊙ For both sections.

\* Minimum.

¶ Heater warm-up time controlled for series-string service.

§ Plate supply voltage.

|| Input plate.

♣—The duration of the pulse voltage must not exceed 15 percent of one scanning cycle.

1—Section 1.

2—Section 2.

♣—A resistor of 3 ohms must be put in series with heater.

Tube Type	Classification by Construction	Base Connections	Outline Dwg	Filament Volts	Filament Amp	Max Plate Watts	Max Plate Volts	Max Screen Volts	Capacitance in Micromicrofarads		
									Input	Out-put	Grid-plate
<i>6BY8</i>	Diode-Pentode	9FN	6-3	6.3	0.6	3.0	300	150	5.5	5.0	0.0035
Diode Section											
<i>6BZ6</i>	Semi-Remote-Cutoff RF Pentode	7CM	5-2	6.3	0.3	2.3	330	165	7.0	3.0	0.015
<i>6BZ7</i>	High-Frequency Twin Triode	9AJ	6-2	6.3	0.4	2.0	250	—	2.6 <sub>1</sub>	1.2 <sub>1</sub>	1.2
<i>6BZ8</i>	High-Frequency Twin Triode	9AJ	6-2	6.3	0.4	2.2	250	—	—	—	—
<i>6C4</i>	Medium-Mu Triode	6BG	5-2	6.3	0.15	3.5 5.0	300 300	—	1.8	1.3	1.6
<b>6C5</b> <i>6C5-GT</i>	Medium-Mu Triode	6Q	8-1 9-12	6.3	0.3	2.5	300	—	3.0 4.4	11.0 12.0	2.0 2.2
6C6	Sharp-Cutoff Pentode	6F	12-2	6.3	0.3	0.75	300	125	5.0	6.5	0.007
6C7	Duplex-Diode Medium-Mu Triode	7G	12-2	6.3	0.3	—	250	—	—	—	—
6C8-G	Medium-Mu Twin Triode	8G	12-8	6.3	0.3	1.0	250	—	—	—	—
<i>6CA6</i>	Beam Power Amplifier	7CV	5-3	6.3	1.2	5.0	130	130	15	9	0.5
6CA7	Power Amplifier Pentode	8ET	T-X	6.3	1.5	25	800	425	—	—	—
6CB5	Beam Power Amplifier	8GD	T-X	6.3	2.5	23	700	200	24	10	0.8
6CB5-A	Beam Power Amplifier	8GD	T-X	6.3	2.5	23	800	200	22	10	0.4
<i>6CB6</i> <i>6CB6-A</i>	Sharp-Cutoff RF Pentode	7CM	5-2	6.3	0.3	2.3	330	165	6.5	3.0	0.015
6CD6-G	Beam Power Amplifier	5BT	16-5	6.3	2.5	15	700	175	24	9.5	0.8
6CD6-GA	Beam Power Amplifier	5BT	T-X	6.3	2.5	20	700	175	22	8.5	1.1
6CD7	Electron-Ray Indicator	8EV	T-X	6.3	0.2	—	300	—	Max target voltage =300 v		

Metal tubes are shown in bold-face type, miniature tubes in italics.

⊙Subminiature type.

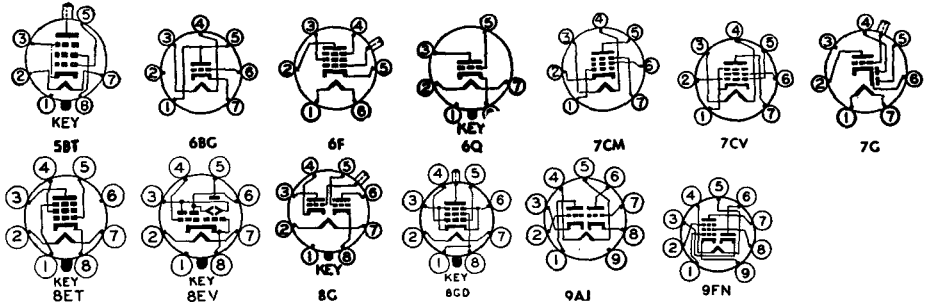

Service	Plate Volts	Screen Volts	Neg Grid Volts	Plate Milli-am-peres	Screen Milli-am-peres	R <sub>p</sub> , Ohms	G <sub>m</sub> , μmhos	μ Factor	Load for Rated Out-put, Ohms	Power Out-put, Watts	Tube Type
Class A Amplifier	250	150	R <sub>k</sub> = 68	10.6	4.3	1,000,000§	5,200	g3 tied to k			6BY8¶
	100	100	R <sub>k</sub> = 150	5.0	2.1	500,000§	3,900	g3 tied to k			
Video Detector	Max d-c output current = 45 ma; voltage drop: 10 volts at 60 ma d-c										
Class A Amplifier	125	125	R <sub>k</sub> = 56	14	3.6	260,000§	8,000	—	—	—	6BZ6
	125	125	4.5	—	—	—	700	—	—	—	
Class A Amplifier ♦	150	—	R <sub>k</sub> = 220	10	—	5,300§	6,800	36	—	—	6BZ7
Class A Amplifier ♦	125	—	R <sub>k</sub> = 100	10	—	5,600§	8,000	45	—	—	6BZ8
Class A Amplifier { Class C Amplifier	250	—	8.5	10.5	—	7,700	2,200	17	—	—	6C4
	100	—	0	11.8	—	6,250	3,100	19.5	—	—	
	300	—	27	25	—	Input signal = 0.35 watt§		—	—	5.5§	
Class A Amplifier	250	—	8.0	8.0	—	10,000	2,000	20	—	—	6C5 6C5-GT
Class A Amplifier	250	100	3.0	2.0	0.5	1,000,000*	1,225	—	—	—	6C6
Class A Amplifier	250	—	9.0	5.5	—	16,000	1,250	20	—	—	6C7
Class A Amplifier ♦	250	—	4.5	3.2	—	22,500	1,600	36	—	—	6C8-G
Class A Amplifier	125	125	4.5	37†	4.0†	15,000§	9,200	—	4,500	1.5	6CA5
	110	110	4.0	32†	3.5†	16,000§	8,100	—	3,500	1.1	
Class A Amplifier	250	250	13.5	100	15	15,000§	11,000	—	2,000	11	6CA7
Horizontal Deflection Amplifier	175	175	30	90	6.0	5,000§	8,800	—	—	—	6CB5
	Max positive pulse plate voltage: ⊠ = 6,800 volts; max screen dissipation = 3.6 watts; max d-c plate current = 200 ma										
Horizontal Deflection Amplifier	175	175	30	90	6.0	5,000§	8,800	—	—	—	6CB5-A
	75	150	0	460	42	—	—	—	—	—	
Max positive pulse plate voltage: ⊠ = 6,800 volts; max screen dissipation = 3.6 watts; max d-c cathode current = 220 ma											
Class A Amplifier	125	125	R <sub>k</sub> = 56	13	3.7	280,000§	8,000	—	—	—	6CB6
	125	125	3.0	2.8	—	—	—	—	—	—	
Horizontal Deflection Amplifier	175	175	30	75	5.5	7,200§	7,700	—	—	—	6CD6-G
	60	100	0	230	21	—	—	—	—	—	
Max positive pulse plate voltage: ⊠ = 6600 volts; max screen dissipation = 3.0 watts; max d-c cathode current = 200 ma											
Horizontal Deflection Amplifier	175	175	30	75	5.5	7,200§	7,700	—	—	—	6CD6-GA
	60	100	0	230	21	—	—	—	—	—	
Max positive pulse plate voltage: ⊠ = 7,000 volts; max screen dissipation = 3.0 watts; max d-c cathode current = 200 ma											
Tuning Indicator	Plate voltage = 250 v thru 1 meg to each plate; target voltage = 250 v (E <sub>g</sub> = -16, shadow angle of sector 2 minimum) (E <sub>g</sub> = -5, shadow angle of sector 1 minimum) (E <sub>g</sub> = 0, shadow angle of both sectors = 180°)										6CD7

§ Approximate.

▲ Without external shield.

† Zero signal.

♦ Grids 3 and 5 are screen. Grid 4 is signal-input grid.

# Conversion transconductance.

♣ Maximum.

▼ Grids 2 and 4 are screen. Grid 3 is signal-input grid.

⊠ Screen supply voltage.

⊡ Absolute maximum rating.

‡ Plate-to-plate.

♣ Per section.

◆ Design maximum rating.

⊙ For both sections.

\* Minimum

¶ Heater warm-up time controlled for series-string service.

§ Plate supply voltage.

|| Input plate.

⊖ The duration of the pulse voltage must not exceed 15 percent of one scanning cycle.

1—Section 1.

2—Section 2.

⊣ A resistor of 3 ohms must be put in series with heater.

Tube Type	Classification by Construction	Base Connections	Out-line Dwg	Fila-ment Volts	Fila-ment Amp	Max Plate Watts	Max Plate Volts	Max Screen Volts	Capacitance in Micromicrofarads		
									Input	Out-put	Grid-plate
<b>6CE5</b>	Sharp-Cutoff RF Pentode	7BD	5-2	6.3	0.3	2.0	300	150	6.5▲	1.9▲	0.03♣
<b>6CF6</b>	Sharp-Cutoff RF Pentode	7CM	5-2	6.3	0.3	2.3◆	330◆	165◆	6.5	3.0	0.015♣
<b>6CG6</b>	Remote-Cutoff Pentode	7BK	5-2	6.3	0.3	4.0	300	150	5.0	5.0	0.008♣
<b>6CG7</b>	Medium- $\mu$ Twin Triode	9AJ	6-3	6.3	0.6	3.5▲ 5.0⊕	300	—	2.3▲	2.2▲	4.0▲
<b>6CG8</b> <b>6CG8-A</b>	Triode Pentode	9GF	6-2	6.3	0.45	2.0 1.5	250 250	250★	Pentode Section Triode Section		
<b>6CH6</b>	RF Pentode	9BA	6-3	6.3	0.75	12	275	275	14▲	5.0▲	0.25▲ ♣
<b>6CH7</b>	High-Frequency Twin Triode	9FC	6-2	6.3	0.4	2.0♣	250	—	2.4 <sub>1</sub>	0.8 <sub>1</sub>	1.1 <sub>1</sub>
<b>6CH8</b>	Triode Pentode	9FT	6-2	6.3	0.45	2.0 2.6	300 300	150 —	Pentode Section Triode Section		
<b>6CJ5</b>	Remote-Cutoff RF Pentode	8GW	T-X	6.3	0.2	2.0	300	125	4.7▲	8.0▲	0.002♣▲
<b>6CJ6</b>	Beam Power Amplifier	9AS	T-X	6.3	1.05	8.0	300	300	—	—	—
<b>6CK5</b>	Power Amplifier Pentode	8GW	T-X	6.3	0.7	9.0	300	300	10.2▲	7.8▲	1.0♣ ▲
<b>6CK6</b>	Power Amplifier Pentode	9AR	6-4	6.3	0.71	9.0	300	300	11.2▲	6.6▲	0.1♣ ▲
<b>6CL5</b>	Beam Power Amplifier	8GD	T-X	6.3	2.5	25	700‡	200	20▲	11.5▲	0.7▲
<b>6CL6</b>	Power Amplifier Pentode	9BV	6-3	6.3	0.65	7.5	300	150	11▲	5.5▲	0.12♣▲
<b>6CL8</b>	Triode-Tetrode	9FX	6-2	6.3	0.45	2.8 2.7	300 300	150 —	Tetrode Section Triode Section		
<b>6CM6</b>	Beam Power Amplifier	9CK	6-3	6.3	0.45	12 9.0 8.0	315 315 315	285 — 285	Pentode Connection Triode (G <sub>2</sub> & P tied) or Pentode Connection		

Metal tubes are shown in bold-face type, miniature tubes in italics.

⊙Subminiature type.

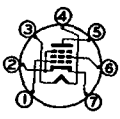
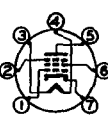
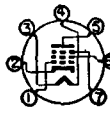
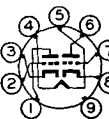
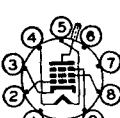
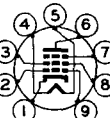
**7BD****7BK****7CM****8GD****8GW****9AJ****9AR****9AS****9BA****9BV****9CK****9FC****9FT****9FX**

Service	Plate Volts	Screen Volts	Neg Grid Volts	Plate Milli-amperes	Screen Milli-amperes	R <sub>p</sub> , Ohms	G <sub>m</sub> , μmhos	μ Factor	Load for Rated Out-put, Ohms	Power Out-put, Watts	Tube Type
Class A Amplifier	125	125	1.0	11	2.8	300,000§	7,600	—	—	—	6CE5¶
Class A Amplifier	125	125	R <sub>k</sub> = 56	12.5	3.7	300,000§	7,800	—	—	—	6CF6
	125	125	3.0	2.2	—	—	—	—	—	—	
Class A Amplifier	250	150	8.0	9.0	2.3	720,000	2,000	—	—	—	6CG6
Class A Amplifier ♦	250	—	8.0	9.0	—	7,700§	2,600	20	—	—	6CG7¶
	250	—	12.5	1.3	—	—	—	—	—	—	
	90	—	0	10	—	6,700§	3,000	20	—	—	
Class A Amplifier Class A Amplifier	250	150	R <sub>k</sub> = 200	7.7	1.6	750,000§	4,600	—	—	—	6CG8 6CG8-A
	100	—	R <sub>k</sub> = 100	8.5	—	6,900§	5,800	40	—	—	
Class A Amplifier	250	250	4.5	40	6.0	50,000	11,000	—	—	—	6CH6
Class A Amplifier ♦	150	—	R <sub>k</sub> = 220	10	—	5,300§	6,800	36	—	—	6CH7
Class A Amplifier Class A Amplifier	200	150	R <sub>k</sub> = 180	9.5	2.8	300,000§	6,200	—	—	—	6CH8
	200	—	6.0	13	—	5,750§	3,300	19	—	—	
Class A Amplifier	250	100	2.5	6.0	1.7	1,000,000§	2,200	—	—	—	6CJ5
Horizontal Deflection Amplifier	250	250	38.5	32	2.4	15,000	4,600	—	—	—	6CJ6
	Max positive pulse plate voltage = 7000 volts; max screen dissipation = 4.5 watts; max plate plus screen dissipation = 10 watts; max d-c cathode current = 180 ma										
Class A Amplifier	250	250	7.0	36	5.2	40,000§	10,000	—	7,000	4.2	6CK5
Class A Amplifier	250	250	5.5	36	5	130,000	10,000	—	—	—	6CK6
Horizontal Deflection Amplifier	175	175	40	90	7.0	6,000§	6,500	—	—	—	6CL5
	80	100	0	280	20	—	—	—	—	—	
Max positive pulse voltage = 7,000 volts; max screen dissipation = 4.0 watts; max d-c cathode current = 240 ma											
Class A Amplifier	250	150	3.0	30†	7.0†	150,000§	11,000	—	7,500	2.8	6CL6
Class A Amplifier Class A Amplifier	125	125	1.0	12	4.0	100,000§	5,800	—	—	—	6CL8¶
	125	—	R <sub>k</sub> = 56	15	—	5,000§	8,000	40	—	—	
Class A Amplifier Vertical Deflection Amplifier	250	250	12.5	45†	4.5†	50,000§	4,100	—	5,000	4.5	6CM6
	Max positive pulse plate voltage = 2000 volts; max screen dissipation (pentode connection only) = 1.75 watts; max d-c cathode current = 40 ma										

§ Approximate.

▲ Without external shield.

† Zero signal.

♦ Grids 3 and 5 are screen. Grid 4 is signal-input grid.

# Conversion transconductance.

◆ Maximum.

♥ Grids 2 and 4 are screen. Grid 3 is signal-input grid.

⊠ Screen supply voltage

⊙ Absolute maximum rating.

‡ Plate-to-plate.

‡ Per section.

◆ Design maximum rating.

⊕ For both sections.

\* Minimum.

¶ Heater warm-up time controlled for series-string service.

§ Plate supply voltage.

|| Input plate.

1—The duration of the pulse voltage must not exceed 15 percent of one scanning cycle.

1—Section 1.

2—Section 2.

4—A resistor of 3 ohms must be put in series with heater.



Tube Type	Classification by Construction	Base Connections	Out-line Dwg	Filament Volts	Filament Amp	Max Plate Watts	Max Plate Volts	Max Screen Volts	Capacitance in Micromicrofarads		
									Input	Out-put	Grid-plate
<i>6CM7</i> †	Medium- $\mu$ Twin Triode	9ES	6-3	6.3	0.6	1.25	500	—	Section 1 (Pins 3, 6, 7)		
						5.5	500	—	Section 2 (Pins 1, 8, 9)		
<i>6CM8</i> †	Triode-Pentode	9FZ	6-2	6.3	0.45	2.0	300	150	Pentode Section		
						1.0	300	—	Triode Section		
6CN6	Beam Power Amplifier	6CN6	T-X	6.3	1.4	25	800	400	18▲	6.5▲	1.2♣▲
<i>6CN7</i> †	Duplex-Diode Triode	9EN	6-2	{ 6.3 3.15 }	{ 0.3 0.6 }	1.0	300	—	1.5▲	0.5▲	1.8▲
									Diode Sections		
<i>6CQ6</i>	Remote-Cutoff RF Pentode	7DB	5-2	6.3	0.2	3.0◻	300◻	300◻	7.0▲	4.5▲	0.01♣▲
<i>6CR6</i>	Diode Remote-Cutoff Pentode	7EA	5-2	6.3	0.3	2.5	300	150	—	—	—
<i>6CS5</i>	Beam Power Amplifier	6CS5	6-3	6.3	1.2	10	300	150	15▲	9.0▲	0.5▲
<i>6CS6</i>	Dual-Control Heptode	7CH	5-2	6.3	0.3	1.0	300	100	5.5	7.5	0.07♣
<i>6CS7</i> †	Twin Triode	9EF	6-3	6.3	0.6	1.25	500	—	Section 1 (Pins 6, 7, 8)		
						6.5	500	—	Section 2 (Pins 1, 3, 9)		
<i>6CT7</i>	Diode-Pentode	8GX	T-X	6.3	0.2	2.0	300	150	4.5▲	5.1▲	0.002♣▲
<i>6CU5</i>	Beam Power Amplifier	7CV	5-3	6.3	1.2	6.0	135	117	13.2▲	8.6▲	0.7▲
6CU6	Beam Power Amplifier	6AM	T-X	6.3	1.2	11	600♠	200	15▲	7.0▲	0.6▲
<i>6CU7</i>	Triode-Hexode Converter	8GY	T-X	6.3	0.23	1.5 0.8	250 175	125 —	Hexode Section Triode Section		
<i>6CV7</i>	Duplex-Diode Triode	8GZ	T-X	6.3	0.23	1.0	300	—	—	—	—
<i>6CW5</i>	Beam Power Amplifier	9CV	6-4	6.3	0.76	12	250	200	—	—	—
<i>6CX7</i>	Medium- $\mu$ Twin Triode	9FC	6-2	6.3	0.4	2.0♣	250	—	2.4 <sub>1</sub>	1.3 <sub>1</sub>	1.2 <sub>1</sub>

Metal tubes are shown in bold-face type, miniature tubes in italics.

‡Subminiature type.

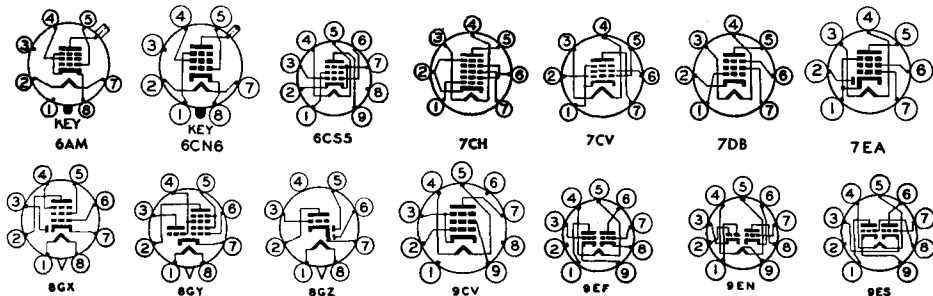

Service	Plate Volts	Screen Volts	Neg Grid Volts	Plate Milli-am-peres	Screen Milli-am-peres	R <sub>p</sub> , Ohms	G <sub>m</sub> , μmhos	μ Fac-tor	Load for Rated Out-put, Ohms	Power Out-put, Watts	Tube Type
Vertical Deflection Oscillator	200	—	7.0	5.0	—	10,500§	2,000	21	—	—	6CM7¶
Vertical Deflection Amplifier	250	—	8.0	20	—	4,100§	4,400	18	—	—	
Class A Amplifier	200	150	R <sub>k</sub> = 180	9.5	2.8	600,000§	6,200	—	—	—	6CM8¶
Class A Amplifier	250	—	2.0	1.8	—	50,000§	2,000	100	—	—	
Horizontal Deflection Amplifier	275	275	9.0	91	11	20,000	14,000	—	—	—	6CN6
Class A Amplifier	250	—	3.0	1.0	—	58,000§	1,200	70	—	—	6CN7¶
Horizontal Phase Detector	100	—	1.0	0.8	—	54,000§	1,300	70	—	—	
Class A Amplifier	250	200	2.5	7.8	2.0	—	2,500	—	—	—	6CQ6
Class A Amplifier	250	100	2.0	9.6	2.6	800,000§	2,200	—	—	—	6CR6
Class A Amplifier	200	125	R <sub>k</sub> = 180	46†	2.2†	28,000§	8,000	—	4,000	3.8	6CS5
Class A Amplifier	110	110	7.5	49†	4.0†	13,000§	8,000	—	2,000	2.1	
Gated Amplifier	100	30	1.0	1.0	1.3	1,000,000§	1,100	E <sub>c3</sub> = 0 volts	—	—	6CS6
Gated Amplifier	100	30	0	0.8	5.5	700,000§	—	E <sub>c3</sub> = -1.0 volts	—	—	
Gated Amplifier	10	30	0	2.0	4.5	—	—	E <sub>c3</sub> = 0 volts	—	—	
Vertical Deflection Oscillator	250	—	8.5	10.5	—	7,700§	2,200	17	—	—	6CS7¶
Vertical Deflection Amplifier	250	—	10.5	19	—	3,450§	4,500	15.5	—	—	
Class A Amplifier	250	85	2.0	5.0	1.5	1,400,000§	2,000	—	—	—	6CT7
Class A Amplifier	120	110	8.0	49†	4.0†	10,000§	7,500	—	2,500	2.3	6CU5
Horizontal Deflection Amplifier	250	150	22.5	57	2.1	14,500	5,900	—	—	—	6CU6
Horizontal Deflection Amplifier	60	150	0	260	26	—	—	—	—	—	
Converter	250	85	2.0	3.0	3.0	1,000,000*	750#	—	—	—	6CU7
Converter	100	—	0	10	—	—	2,800	22	—	—	
Class A Amplifier	250	—	3.0	1.0	—	54,000§	1,300	70	—	—	6CV7
Class A Amplifier	170	170	12.5	70†	5.0†	23,000	10,000	—	2,400	5.6	6CW5
Class A Amplifier	150	—	R <sub>k</sub> = 220	9.0	—	6,100§	6,400	39	—	—	6CX7

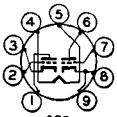

9FC

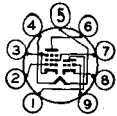

9FZ

- § Approximate.
- ▲ Without external shield.
- † Zero signal.
- ‡ Grids 3 and 5 are screen. Grid 4 is signal-input grid.
- # Conversion transconductance.
- ◆ Maximum.
- ▼ Grids 2 and 4 are screen. Grid 3 is signal-input grid.
- \* Screen supply voltage.
- Absolute maximum rating.
- ▣ Plate-to-plate.
- ‡ Per section.
- ◆ Design maximum rating.

- ⊕ For both sections.
- \* Minimum.
- ¶ Heater warm-up time controlled for series-string service.
- § Plate supply voltage.
- || Input plate.
- 3—The duration of the pulse voltage must not exceed 15 percent of one scanning cycle.
- 1—Section 1.
- 2—Section 2.
- 4—A resistor of 3 ohms must be put in series with heater.

Tube Type	Classification by Construction	Base Connections	Out-line Dwg	Fila-ment Volts	Fila-ment Amp	Max Plate Watts	Max Plate Volts	Max Screen Volts	Capacitance in micromicrofarads		
									Input	Out-put	Grid-plate
<i>6D4</i>	Gas Triode	5AY	5-2	6.3	0.25	—	Tube Voltage Drop: § 16 v at 25 ma d-c				
6D6	Remote-Cutoff RF Pentode	6F	12-2	6.3	0.3	2.25	300	150	4.7 ▲	6.5 ▲	0.007 ♣
6D7	Sharp-Cutoff Pentode	7H	12-2	6.3	0.3	—	300	125	5.2 ▲	6.8 ▲	0.01 ▲ ♣
6D8-G	Pentagrid Converter	8A♦	12-8	6.3	0.15	1.0	300	100	Osc I <sub>g1</sub> = 0.4 ma R <sub>g1</sub> = 50,000 ohms		
<i>6DA6</i>	Remote-Cutoff RF Pentode	9BA	T-X	6.3	0.2	2.25	300	300	5.5 ▲	5.1 ▲	0.002 ♣ ▲
<i>6DB6</i>	Dual-Control Pentode	7CM	5-2	6.3	0.3	3.0	300	150	6.0 ▲	5.0 ▲	0.0035 ♣ ▲
<i>6DC6</i>	Semi-Remote-Cutoff Pentode	7CM	5.2	6.3	0.3	2.0	300	150	6.5 ▲	2.0 ▲	0.02 ♣ ▲
<i>3DE6</i>	Sharp-Cutoff RF Pentode	7CM	5-2	6.3	0.3	2.3 ♦	330 ♦	165 ♦	6.5	3.0	0.015 ♣
6DG6-GT	Beam Power Amplifier	7S	9-11 or 9-41	6.3	1.2	10	200	125	—	—	—
6DN6	Beam Power Amplifier	5BT	T-X	6.3	2.5	15	700 §	175	22 ▲	11.5 ▲	0.8 ▲
6DQ6	Beam Power Amplifier	6AM	T-X	6.3	1.2	15	550 §	175	15 ▲	7.0 ▲	0.55 ▲
6DQ6-A	Beam Power Amplifier	6AM	T-X	6.3	1.2	15	700 §	200	15 ▲	7.0 ▲	0.55 ▲
<i>6DR6</i>	Beam Power Amplifier	9AS	T-X	6.3	0.3	8.0	300	150	—	—	—
<i>6DT6</i>	Sharp-Cutoff Pentode	7EN	5-2	6.3	0.3	1.5	300	150	Ic1 = 0.6 ma		
6E5	Electron-Ray Indicator	6R	9-26	6.3	0.3	—	250 §	Max target voltage = 250 Min target voltage = 125			
6E6	Twin-Triode Power Amplifier	7B	14-1	6.3	0.6	—	250	—	Both Sections in Push-pull		
6E7	Remote-Cutoff RF Pentode	7H	12-2	6.3	0.3	—	300	100	5.2 ▲	6.8 ▲	0.01 ▲
6F4	High-Frequency Triode (Acorn)	7BR	4-2	6.3	0.225	2.0	150	—	1.9 ▲	0.6 ▲	1.8 ▲

Metal tubes are shown in bold-face type, miniature tubes in *italics*.

©Subminiature type.

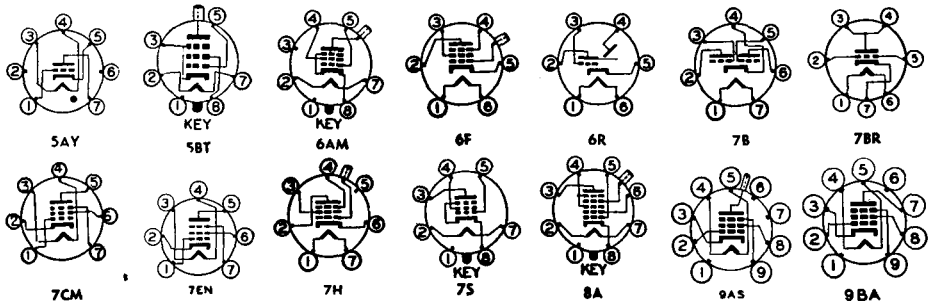



Service	Plate Volts	Screen Volts	Neg Grid Volts	Plate Milli-am-peres	Screen Milli-am-peres	R <sub>p</sub> , Ohms	G <sub>m</sub> , μmhos	μ Factor	Load for Rated Output, Ohms	Power Output, Watts	Tube Type
Relay Control	Max d-c cathode current = 25 ma; max voltage between elements = 450 volts; max peak cathode current = 100 ma										6D4
Class A Amplifier	250	100	3.0	8.2	2.0	800,000§	1,600	—	—	—	6D6
Class A Amplifier	250	100	3.0	2.0	0.5	1,000,000*	1,225	—	—	—	6D7
Converter	250	100	3.0	3.5	2.6	400,000§	550 #	E <sub>c2</sub> (Osc Plate) = 250 thru 20,000 ohms I <sub>c2</sub> = 4.3 ma			6D8-G
Class A Amplifier	250	100	2.0	9.0	3.0	1,000,000*	3,600	—	—	—	6DA6
Class A Amplifier	150	150	1.0	5.8	6.6	50,000§	2,050	E <sub>c3</sub> = -3.0 volts			6DB6
Class A Amplifier	200	150	R <sub>k</sub> = 180	9.0	3.0	500,000§	5,500	—	—	—	6DC6
Class A Amplifier	125	125	R <sub>k</sub> = 56	15.5	4.2	250,000§	8,000	—	—	—	6DE6
	125	125	5.5	—	—	—	700	—	—	—	
Class A Amplifier	200	125	R <sub>k</sub> = 180	46†	2.2†	28,000§	8,000	—	4,000	3.8	6DG6-GT
	110	110	7.5	49†	4.0†	13,000§	8,000	—	2,000	2.1	
Horizontal Deflection Amplifier	125	125	18	70	6.3	4,000§	9,000	—	—	—	6DN6
	50	100	0	240	30	—	—	—	—	—	
Max positive pulse plate voltage □ = 6,600 volts; max screen dissipation = 3.0 watts; max d-c cathode current = 200 ma											
Horizontal Deflection Amplifier	250	150	22.5	75	2.4	20,000§	6,000	—	—	—	6DQ6
	60	150	0	300	27	—	—	—	—	—	
Max positive pulse plate voltage □ = 6,000 volts; max screen dissipation = 2.5 watts; max d-c cathode current = 120 ma											
Horizontal Deflection Amplifier	250	150	22.5	75	2.4	20,000	6,600	—	—	—	6DQ6-A
	60	150	0	300	27	—	—	—	—	—	
Max positive pulse plate voltage □ = 6,000 volts; max screen dissipation = 3.0 watts; max d-c cathode current = 140 ma											
Horizontal Deflection Amplifier	250	250	38.5	32	2.4	15,000	4,600	—	—	—	6DR6
	60	150	0	300	27	—	—	—	—	—	
Max positive pulse plate voltage □ = 7,000 volts; max screen dissipation = 4.5 watts; max plate plus screen dissipation = 10 watts; max d-c cathode current = 180 ma											
Class A Amplifier FM Limiter Discriminator	150	100	R <sub>k</sub> = 560	1.1	2.1	150,000§	800	E <sub>c3</sub> = 0 volts			6DT6
	250‡	100	R <sub>k</sub> = 560	0.22	5.5	E <sub>c3</sub> = -6.0 volts	—	270,000	—	—	
Tuning Indicator	Plate voltage = 250 thru 1 meg, Target voltage = 250 (E <sub>g</sub> = -8 v, Shadow = 0°) (E <sub>g</sub> = 0 v, Shadow = 90°, Plate current = 0.24 ma, Target current § = 4 ma)										6E5
Class A Amplifier	250	—	27.5	18†	—	3,500	1,700	6.0	14,000	1.6	6E6
						♣	♣	♣	‡		
Class A Amplifier	250	100	3.0	8.2	2.0	800,000	1,600	—	—	—	6E7
Class A Amplifier	80	—	R <sub>k</sub> = 105	13	—	2,900	5,800	17	—	—	6F4

§ Approximate.

▲ Without external shield.

† Zero signal.

♦ Grids 3 and 5 are screen. Grid 4 is signal-input grid.

# Conversion transconductance.

♣ Maximum.

♥ Grids 2 and 4 are screen. Grid 3 is signal-input grid.

✱ Screen supply voltage.

□ Absolute maximum rating.

‡ Plate-to-plate.

♣ Per section.

◆ Design maximum rating.

⊗ For both sections.

\* Minimum.

¶ Heater warm-up time controlled for series-string service.

‡ Plate supply voltage.

|| Input plate.

§ The duration of the pulse voltage must not exceed 15 percent of one scanning cycle.

1—Section 1.

2—Section 2.

‡ A resistor of 3 ohms must be put in series with heater.

Tube Type	Classification by Construction	Base Connections	Out-line Dwg	Fila-ment Volts	Fila-ment Amp	Max Plate Watts	Max Plate Volts	Max Screen Volts	Capacitance in Micromicrofarads		
									Input	Out-put	Grid-plate
<b>6F5</b> <i>6F5-G</i> <b>6F5-GT</b>	High-Mu Triode	5M	8-4 12-8 9-17 or 9-47	6.3	0.3	—	300	—	—	—	—
<b>6F6</b> <i>6F6-G</i> <b>6F6-GT</b>	Power Amplifier Pentode	7S	8-6 14-3 9-15	6.3	0.7	11	375	285	Single Tube 2 Tubes, Push-pull		
<b>6F7</b>	Triode-Remote-Cutoff Pentode	7E	12-6	6.3	0.3	1.7 0.4	250 100	100 —	Pentode section Triode section		
<b>6F8-G</b>	Medium-Mu Twin Triode	8G	12-8	6.3	0.6	2.5 ♣	300	—	—	—	—
<b>6G6-G</b> <b>6G6-GT</b>	Power Amplifier Pentode	7S	12-7 9-11 or 9-41	6.3	0.15	2.75	300 300	300 —	Pentode connection Triode connection (G <sub>2</sub> & P tied)		
<b>6H4-GT</b>	Diode	5AF	9-11	6.3	0.15	—	—	—	—	—	—
<b>6H6</b> <b>6H6-GT</b>	Twin Diode	7Q	8-5 9-11	6.3	0.3	—	Tube Voltage Drop: ♣ 11 v at 16 ma d-c				
<b>6J4</b>	High-Frequency Triode	7BQ	5-2	6.3	0.4	2.25	150	—	—	—	—
<b>6J5</b> <b>6J5-GT</b>	Medium-Mu Triode	6Q	8-1 9-12	6.3	0.3	2.5	300	—	3.4 4.2	3.6 5.0	3.4 3.8
<b>6J6</b> <b>6J6-A</b> ¶	Medium-Mu Twin Triode	7BF	5-2	6.3	0.45	1.5 ♣ 1.5 ♣	300 300	—	2.6 1.6 <sub>1</sub> 1.0 <sub>2</sub> Both Sections in Push-pull		
<b>6J7</b> <b>6J7-G</b> <b>6J7-GT</b>	Sharp-Cutoff Pentode	7R	8-4 12-8 9-18	6.3	0.3	0.75 1.75	300 250	150 —	Pentode connection Triode connection (G <sub>2</sub> , G <sub>3</sub> & P tied)		
<b>6J8-G</b>	Triode-Heptode Converter	8H	12-8	6.3	0.3	0.4 0.75	300 150	100 —	Osc I <sub>g1</sub> = 0.4 ma R <sub>g1</sub> = 50,000 ohms Triode Section		
<b>6K4</b> ⊙	Medium-Mu Triode	6K4	3-2	6.3	0.15	3.0	250	—	2.4 ▲	0.8 ▲	2.4 ▲
<b>6K5-G</b> <b>6K5-GT</b>	High-Mu Triode	5U	12-8 9-17	6.3	0.3	—	250	—	2.4 ▲	3.6 ▲	2.0 ▲

Metal tubes are shown in bold-face type, miniature tubes in italics.

⊙ Subminiature type.

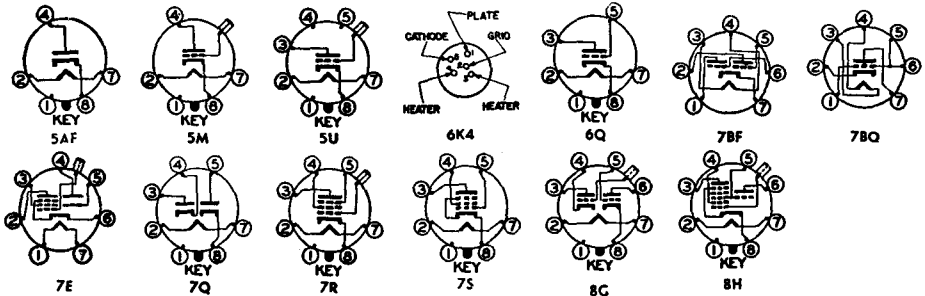

Service	Plate Volts	Screen Volts	Neg Grid Volts	Plate Milli-amperes	Screen Milli-amperes	R <sub>p</sub> Ohms	G <sub>m</sub> μmhos	μ Factor	Load for Rated Output, Ohms	Power Output, Watts	Tube Type
Class A Amplifier	250 100	— —	2.0 1.0	0.9 0.4	— —	66,000§ 85,000§	1,500 1,150	100 100	— —	— —	6F5 6F5-G 6F5-GT
Class A Amplifier	285	285	20	38†	7.0†	78,000§	2,550	—	7,000	4.8	6F6
Class A Amplifier	250	250	16.5	34†	6.5†	80,000§	2,500	—	7,000	3.2	6F6-G
Class A Amplifier	315	285	24	62†	12†	—	—	—	10,000 ‡	11	6F6-GT
Class A Amplifier	250	100	3.0	6.5	1.5	850,000	1,100	—	—	—	6F7
Class A Amplifier	100	—	3.0	3.5	—	16,000	500	8.0	—	—	6F7
Class A Amplifier	250	—	8.0	9.0	—	7,700§	2,600 §	20	—	—	6F8-G
Class A Amplifier	180	180	9.0	15†	2.5†	175,000	2,300	—	10,000	1.1	6G6-G
Class A Amplifier	180	—	12	11†	—	4,750	2,000	9.5	12,000	0.25	6G6-GT
Half-Wave Rectifier	Max d-c output current = 4 ma; max rms supply voltage = 100 volts; max peak current = 18 ma										6H4-GT
Half-Wave Rectifier	Max d-c output current per plate = 8 ma; max peak inverse voltage = 420 volts; max rms supply voltage per plate = 150 volts; max peak current per plate = 48 ma										6H6 6H6-GT
Class A Amplifier	150	—	R <sub>k</sub> = 100	15	—	4,500§	12,000	55	—	—	6J4
Class A Amplifier	250 90	—	8.0 0	9.0 10	—	7,700§ 6,700§	2,600 3,000	20 20	— —	— —	6J5 6J5-GT
Class A Amplifier	100	—	R <sub>k</sub> = 50 ⊕	8.5	—	7,100§	5300	38	—	—	6J6
Class C Amplifier	150	—	10	30	—	Input Signal = 0.35 watt§ I <sub>gr</sub> = 16 ma d-c§			—	3.5§	6J6-A ¶
Class A Amplifier	250	100	3.0	2.0	0.5	1,000,000*	1,225	—	—	—	6J7
Class A Amplifier	100	100	3.0	2.0	0.5	1,000,000	1,185	—	—	—	6J7-G
Class A Amplifier	250	—	8.0	6.5	—	10,500	1,900	20	—	—	6J7-GT
Converter	250	100	3.0	1.3	3.5	2,500,000§	290 #	E <sub>b</sub> (Triode Osc) = 250 thru 20,000 ohms I <sub>b</sub> (Triode) = 5.8 ma			6J8-G
Class A Amplifier	200	—	R <sub>k</sub> = 680	11.5	—	4,650	3,450	16	—	—	6K4 ⊙
Class A Amplifier	250	—	3.0	1.1	—	50,000§	1,400	70§	—	—	6K5-G 6K5-GT

§ Approximate.

▲ Without external shield.

† Zero signal.

♦ Grids 3 and 5 are screen. Grid 4 is signal-input grid.

# Conversion transconductance.

♣ Maximum.

♥ Grids 2 and 4 are screen. Grid 3 is signal-input grid.

✱ Screen supply voltage.

⊕ Absolute maximum rating.

‡ Plate-to-plate.

♠ Per section.

⊙ Design maximum rating.

⊕ For both sections.

\* Minimum.

¶ Heater warm-up time controlled for series-string service.

‡ Plate supply voltage.

|| Input plate.

3—The duration of the pulse voltage must not exceed 15 percent of one scanning cycle.

1—Section 1.

2—Section 2.

4—A resistor of 3 ohms must be put in series with heater.

Tube Type	Classification by Construction	Base Connections	Out-line Dwg	Filament Volts	Filament Amp	Max Plate Watts	Max Plate Volts	Max Screen Volts	Capacitance in Micromicrofarads		
									Input	Out-put	Grid-plate
6K6-GT	Power Amplifier Pentode	7S	9-11 or 9-41	6.3	0.4	8.5	315	285	Single Tube 2 Tubes, Push-Pull Triode Connection (G <sub>2</sub> & P tied)		
<b>6K7</b> 6K7-G 6K7-GT	Remote-Cutoff RF Pentode	7R	8-4 12-8 9-18	6.3	0.3	2.75	300	150	7.0 5.0 4.6	12.0 12.0 12.0	0.005 0.007 0.005
<b>6K8</b> 6K8-G 6K8-GT	Triode-Hexode Converter	8K ♠	8-2 12-8 9-24	6.3	0.3	0.75 ♠	300	150	Osc I <sub>g1</sub> = 0.15 ma R <sub>g1</sub> = 50,000 ohms		
6L4	Medium-Mu Triode (Acorn)	7BR	4-2	6.3	0.225	1.7	500	—	0.5 ▲	1.8 ▲	1.6 ▲
6L5-G	Medium-Mu Triode	6Q	12-7	6.3	0.15	—	250	—	3.0	5.0	2.7
<b>6L6</b> 6L6-G 6L6-GA 6L6-GB	Beam Power Amplifier	7AC	10-1 16-3 14-3 T-X	6.3	0.9	19	360	270	Single Tube Single Tube 2 Tubes, Push-pull 2 Tubes, Push-pull 2 Tubes, Push-pull Triode Connection (G <sub>2</sub> & P Tied)		
<b>6L7</b> 6L7-G	Pentagrid Mixer	7T	8-4 12-8	6.3	0.3	1.5 1.0	300 300	100 150	— — — E <sub>g3</sub> (Injection) = 18 v peak*		
6M3	Half-Wave High-Vacuum Rectifier	8GV	T-X	6.3	3.0	8.0	Tube Voltage Drop: 22 v at 640 ma d-c				
<i>6M5</i>	Power Amplifier Pentode	9N	6-4	6.3	0.71	9.0	300	100	Single Tube 2 Tubes, Push-pull		
<i>6N4</i>	Medium-Mu Triode	7CA	5-1	6.3	0.2	3.0	180	—	3.0	1.6	1.1
6N6-G	Direct-Coupled Power Amplifier Triode	7AU	14-3	6.3	0.8	13.5 2.5	300	300	— — —		
<b>6N7</b> 6N7-G 6N7-GT	Twin-Triode Power Amplifier	8B	8-6 14-3 9-11	6.3	0.8	1.0 ♠	300	—	Both Sections in Push-pull Both Sections in Parallel		

Metal tubes are shown in bold-face type, miniature tubes in italics.

♠ Subminiature type.

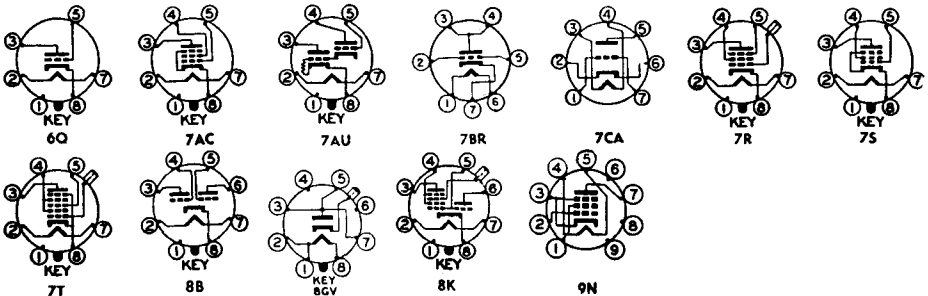

Service	Plate Volts	Screen Volts	Neg Grid Volts	Plate Milli-am-peres	Screen Milli-am-peres	R <sub>p</sub> , Ohms	G <sub>m</sub> , μmhos	μ Factor	Load for Rated Output, Ohms	Power Out-put, Watts	Tube Type
Class A Amplifier	315	250	21	25.5†	4.0†	110,000§	2,100	—	9,000	4.5	6K6-GT
	250	250	18	32†	5.5†	90,000§	2,300	—	7,600	3.4	
	100	100	7.0	9.0†	1.6†	104,000§	1,500	—	12,000	0.35	
Class A Amplifier	285	285	R <sub>k</sub> = 400	55†	9.0†	—	—	—	12,000	9.8	
	285	285	25.5	55†	9.0†	—	—	—	12,000	10.5	
Vertical Deflection Amplifier	250	—	18	37.5	—	2,500§	2,700	6.8	—	—	
Max positive pulse plate voltage ⊠ = 1200 volts; max d-c cathode current = 25 ma											
Class A Amplifier	250	125	3.0	10.5	2.6	600,000§	1,650	—	—	—	6K7 6K7-G 6K7-GT
	250	100	3.0	7.0	1.7	800,000§	1,450	—	—	—	
	100	100	1.0	9.5	2.7	150,000§	1,650	—	—	—	
Converter	250	100	3.0	2.5	6.0	600,000§	350 #	E <sub>b</sub> (Triode Osc) = 100 I <sub>b</sub> (Triode) = 3.8 ma		—	6K8 6K8-G 6K8-GT
Class A Amplifier	80	—	R <sub>k</sub> = 150	9.5	—	4,400	6400	28	—	—	6L4
Class A Amplifier	250	—	9.0	8.0	—	9,000	1,900	17	—	—	6L5-G
Class A Amplifier	250	250	14	72†	5.0†	22,500	6,000	—	2,500	6.5	6L6 6L6-G 6L6-GA 6L6-GB
	350	250	18	54†	2.5†	33,000	5,200	—	4,200	10.8	
	270	270	17.5	134†	11†	23,500	5,700	—	5,000	17.5	
	360	270	22.5	88†	5.0†	—	—	—	3,800	18	
	360	270	22.5	88†	5.0†	—	—	—	3,800	47	
	250	—	20	40†	—	1,700	4,700	8.0	5,000	1.4	
Class A Amplifier Mixer	250	100	3.0	5.3	6.5	600,000§	1,100	E <sub>c3</sub> = -3.0 volts		—	6L7 6L7-G
	250	150	6.0*	3.3	9.2	1,000,000*	350 #	E <sub>c3</sub> = -15 volts		—	
TV Dampner Service 3	Max d-c output current = 320 ma; max peak inverse voltage ⊠ = 6,000 volts; max peak current = 1,100 ma										6M3
Class A Amplifier	250	250	R <sub>k</sub> = 170	36	5.2	40,000	10,000	—	7,000	3.9	6M5
	250	250	R <sub>k</sub> = 85	79	16	—	—	—	7,000†	9.4	
Class A Amplifier	180	—	3.5	12	—	5,400§	6,000	32	—	—	6N4
Class A Amplifier	300	300	0	45	8.0	24,000§	2,400	—	7,000	4.0	6N6-G
Class B Amplifier	300	—	0	35†	—	—	—	—	8,000†	10§	6N7 6N7-G 6N7-GT
	294	—	6.0	7.0	—	11,000	3,200	35	—	—	

§ Approximate.

▲ Without external shield.

† Zero signal.

♦ Grids 3 and 5 are screen. Grid 4 is signal-input grid.

# Conversion transconductance.

♣ Maximum.

♥ Grids 2 and 4 are screen. Grid 3 is signal-input grid.

\* Screen supply voltage.

⊠ Absolute maximum rating.

† Plate-to-plate.

♣ Per section.

◆ Design maximum rating.

⊙ For both sections.

\* Minimum.

¶ Heater warm-up time controlled for series-string service.

§ Plate supply voltage.

|| Input plate.

3—The duration of the pulse voltage must not exceed 15 percent of one scanning cycle.

1—Section 1.

2—Section 2.

4—A resistor of 3 ohms must be put in series with heater.

Tube Type	Classification by Construction	Base Connections	Out-line Dwg	Fila-ment Volts	Fila-ment Amp	Max Plate Watts	Max Plate Volts	Max Screen Volts	Capacitance in Micromicrofarads		
									Input	Out-put	Grid-plate
<i>6N8</i>	Duplex-Diode Pentode	9T	6-3	6.3	0.3	2.0	250	250	—	—	—
6P5-GT	Medium-Mu Triode	6Q	9-11	6.3	0.3	1.25	250	—	3.4	5.5	2.6
6P7-G	Triode-Pentode	7U	12-8	6.3	0.3	1.7 0.4	250 100	100	Pentode Section Triode Section		
<i>6Q4</i>	High-Frequency Triode	9S	6-2	6.3	0.48	4.0	300	—	5.4	0.06♣	3.4
6Q7 6Q7-G 6Q7-GT	Duplex-Diode High-Mu Triode	7V	8-4 12-8 9-18	6.3	0.3	—	300	—	—	—	—
<i>6R4</i>	High-Frequency Triode	9R	6-2	6.3♣	0.2	3.5	275	—	1.7	0.5	1.5
6R7 6R7-G 6R7-GT	Duplex-Diode Medium-Mu Triode	7V	8-4 12-8 9-17	6.3	0.3	2.5	250	—	4.8	3.8	2.4
<i>6R8</i>	Triple-Diode, Low-Mu Triode	9E	6-2	6.3	0.45	2.5	250	—	—	—	—
6S2 6S2-A	Half-Wave High-Voltage Rectifier	9DT	T-X	6.3	0.09	—	—	—	—	—	—
6S4 6S4-A♣	Medium-Mu Triode	9AC	6-3	6.3	0.6	7.5	500	—	4.2	0.9	2.6
6S7 6S7-G	Remote-Cutoff RF Pentode	7R	8-2 12-8	6.3	0.15	2.25	300	150	6.5 4.4	10.5 8.0	0.005 ♣ 0.008 ♣
6S8-GT	Triple-Diode High-Mu Triode	8CB	9-23 or 9-48	6.3	0.3	0.5	300	—	—	—	—
6SA7 6SA7-GT	Pentagrid Converter	8R♥ 8AD♥	8-1 9-11 or 9-41	6.3	0.3	1.0	300	100	Osc $I_{g1} = 0.5$ ma $R_{g1} = 20,000$ ohms		
6SB7-Y	Pentagrid Converter	8R♥	8-1	6.3	0.3	2.0	300	100	Osc $I_{g1} = 0.35$ ma $R_{g1} = 20,000$ ohms		
6SC7 6SC7-GT	High-Mu Twin-Triode	8S	8-1 9-11	6.3	0.3	—	250	—	—	—	—
6SD7-GT	Semi-Remote-Cutoff Pentode	8N	9-12	6.3	0.3	4.0	300	125	9.0	7.5	0.0035 ♣
6SE7-GT	Sharp-Cutoff Pentode	8N	9-12	6.3	0.3	4.0	300	125	8.0	7.5	0.005 ♣
6SF5 6SF5-GT	High-Mu Triode	6AB	8-1 9-11	6.3	0.3	—	300	—	—	—	—
6SF7	Diode Remote-Cutoff Pentode	7AZ	8-1	6.3	0.3	3.5	300	100	5.5	6.0	0.004 ♣

Metal tubes are shown in bold-face type, miniature tubes in italics. ©Subminiature type.

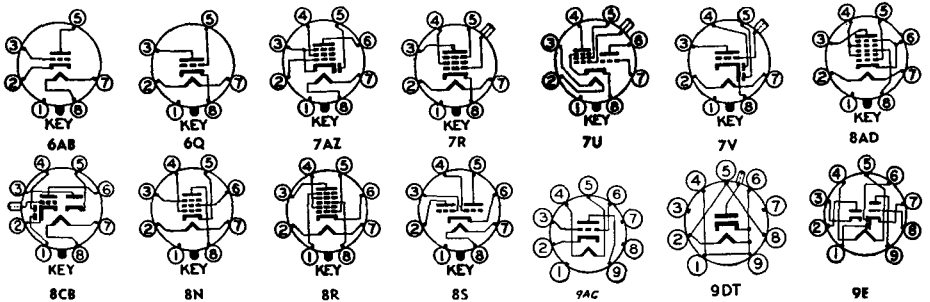

Service	Plate Volts	Screen Volts	Neg Grid Volts	Plate Milli-amperes	Screen Milli-amperes	R <sub>p</sub> ' Ohms	G <sub>m</sub> ' μmhos	μ Factor	Load for Rated Out-put, Ohms	Power Out-put, Watts	Tube Type
Class A Amplifier	250	85	R <sub>k</sub> = 295	5.0	1.75	1,600,000	2,200	35	—	—	6N8
Class A Amplifier	250	—	13.5	5.0	—	9,500	1,450	13.8	—	—	6P5-GT
Class A Amplifier	250	100	3.0	6.5	1.5	850,000	1,100	—	—	—	6P7-G
Class A Amplifier	100	—	3.0	3.5	—	16,000	500	8.0	—	—	6P7-G
Class A Amplifier	250	—	1.5	15	—	—	12,000	80	—	—	6Q4
Class A Amplifier	250	—	3.0	1.0	—	58,000	1,200	70	—	—	6Q7
Class A Amplifier	100	—	1.0	0.8	—	58,000	1,200	70	—	—	6Q7-G 6Q7-GT
Class A Amplifier	150	—	2.0	30	—	—	5,500	16	—	—	6R4
Class A Amplifier	120	—	2.0	20	—	—	4,000	16	—	—	6R4
Class A Amplifier	250	—	9.0	9.5	—	8,500	1,900	16	—	—	6R7 6R7-G 6R7-GT
Class A Amplifier	250	—	9.0	9.5	—	8,500	1,900	16	10,000	0.30	6R8
TV Flyback Rectifiers	Max d-c output current = 0.8 ma; max inverse voltage (d-c component) = 22,000 volts; max peak current = 40 ma										6S2 6S2-A
Vertical Deflection Amplifier	250	—	8.0	26	—	3,600§	4,500	16	—	—	6S4 6S4-A ¶
	Max positive pulse plate voltages □ = 2,200 volts; max d-c cathode current = 30 ma										
Class A Amplifier	250	100	3.0	8.5	2.0	1,000,000§	1,750	—	—	—	6S7 6S7-G
Class A Amplifier	250	—	2.0	0.9	—	91,000§	1,100	100	—	—	6S8-GT
Converter	250	100	2.0	3.5	8.5	1,000,000§	450#	—	—	—	6SA7
Converter	100	100	2.0	3.3	8.5	500,000§	425#	—	—	—	6SA7-GT
Converter	250	100	1.0	3.8	10	1,000,000§	950#	—	—	—	6SB7-Y
Class A Amplifier ♦	250	—	2.0	2.0	—	53,000§	1,325§	70	—	—	6SC7 6SC7-GT
Class A Amplifier	250	125	2.0	9.5	3.0	700,000	4,250	—	—	—	6SD7-GT
Class A Amplifier	250	100	1.5	4.5	1.5	1,000,000	3,400	—	—	—	6SE7-GT
Class A Amplifier	250	—	2.0	0.9	—	66,000	1,500	100	—	—	6SF5
Class A Amplifier	100	—	1.0	0.4	—	85,000	1,150	100	—	—	6SF5-GT
Class A Amplifier	250	100	1.0	12.4	3.3	700,000§	2,050	—	—	—	6SF7



9R

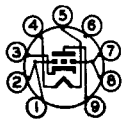

9S

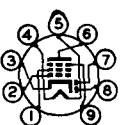

9T

- § Approximate.
- ▲ Without external shield.
- † Zero signal.
- ‡ Grids 3 and 5 are screen. Grid 4 is signal-input grid.
- # Conversion transconductance.
- ♦ Maximum.
- ◆ Grids 2 and 4 are screen. Grid 3 is signal-input grid.

- \* Screen supply voltage.
- Absolute maximum rating.
- † Plate-to-plate.
- ‡ Per section.
- ♦ Design maximum rating.
- ◆ For both sections.
- \* Minimum.
- ¶ Heater warm-up time controlled for series-string service.
- § Plate supply voltage.
- || Input plate.
- The duration of the pulse voltage must not exceed 15 percent of one scanning cycle.
- 1—Section 1.
- 2—Section 2.
- 4—A resistor of 3 ohms must be put in series with heater.

Tube Type	Classification by Construction	Base Connections	Out-line Dwg	Filament Volts	Filament Amp	Max Plate Watts	Max Plate Volts	Max Screen Volts	Capacitance in Micromicrofarads		
									Input	Output	Grid-plate
<b>6SG7</b> 6SG7-GT	Semi-Remote-Cutoff RF Pentode	8BK	8-1 9-12	6.3	0.3	3.0	300	150	8.5	7.0	0.003 ♣ 0.0035 ♣
<b>6SH7</b> 6SH7-GT	Sharp-Cutoff RF Pentode	8BK	8-1 9-12	6.3	0.3	3.0	300	150	8.5	7.0	0.003 ♣
<b>6SJ7</b> 6SJ7-GT	Sharp-Cutoff Pentode	8N	8-1 9-12	6.3	0.3	2.5 2.5	300 250	150 —	Pentode Connection Triode Connection (G <sub>2</sub> , G <sub>3</sub> & P tied)		
<b>6SK7</b> 6SK7-GT	Remote-Cutoff RF Pentode	8N	8-1 9-12	6.3	0.3	4.0	300	150	6.0 6.5	7.0 7.5	0.003 ♣ 0.005 ♣
6SL7-GT	High-Mu Twin-Triode	8BD	9-11 or 9-41	6.3	0.3	1.0 ♣	300	—	—	—	—
6SN7-GT	Medium-Mu Twin Triode	8BD	9-11 or 9-41	6.3	0.6	3.5 ♣ 5.0 ⊕	300	—	2.8 <sub>1</sub> ▲ 3.0 <sub>2</sub> ▲	0.8 <sub>1</sub> ▲ 1.2 <sub>2</sub> ▲	3.8 <sub>1</sub> ▲ 4.0 <sub>2</sub> ▲
6SN7-GTA 6SN7- GTB ¶	Medium-Mu Twin Triode	8BD	9-11 or 9-41	6.3	0.6	5.0 ♣ 7.5 ⊕	450	—	2.2 <sub>1</sub> ▲ 2.6 <sub>2</sub> ▲	0.7 ▲	4.0 <sub>1</sub> ▲ 3.8 <sub>2</sub> ▲
<b>6SQ7</b> 6SQ7-GT	Duplex-Diode, High-Mu Triode	8Q	8-1 9-12	6.3	0.3	0.5	300	—	3.2 4.2 ▲	3.0 3.4 ▲	1.6 1.8 ▲
<b>6SR7</b> 6SR7-GT	Duplex-Diode Medium-Mu Triode	8Q	8-1 9-11	6.3	0.3	2.5	250	—	3.6 —	2.8 —	2.4 —
<b>6SS7</b>	Remote-Cutoff RF Pentode	8N	8-1	6.3	0.15	2.25	300	100	5.5	7.0	0.004 ♣
<b>6ST7</b>	Duplex-Diode Medium-Mu Triode	8Q	8-1	6.3	0.15	2.5	250	—	2.8	3.0	1.5
6SU7- GTY	High-Mu Twin-Triode	8BD	9-11	6.3	0.3	1.0 ♣	250	—	—	—	—
<b>6SV7</b>	Diode Sharp-Cutoff RF Pentode	7AZ	8-1	6.3	0.3	2.3	300	150	6.5	6.0	0.004 ♣
<b>6SZ7</b>	Duplex-Diode High-Mu Triode	8Q	8-1	6.3	0.15	—	300	—	2.6	2.8	1.1
6T4	UHF Triode Oscillator	7DK	5-1	6.3	0.225	3.5	200	—	2.6 ▲	0.4 ▲	1.7 ▲
6T5	Electron-Ray Indicator	6R	9-26	6.3	0.3	—	250 ♣	—	—	—	—
6T7-G	Duplex-Diode High-Mu Triode	7V	12-8	6.3	0.15	—	250	—	1.8	3.1	1.7
6T8 6T8-A ¶	Triple-Diode High-Mu Triode	9E	6-2	6.3	0.45	1.0	300	—	1.6 ▲	1.1 ▲	1.8 ▲

Metal tubes are shown in bold-face type, miniature tubes in italics.

♣ Subminiature type.



6R

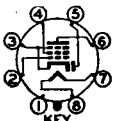

7AZ



70A

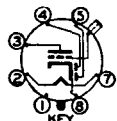

7V

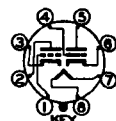

8BD

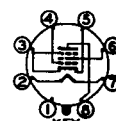

8BK



8N

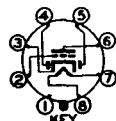

8Q



9E



Service	Plate Volts	Screen Volts	Neg Grid Volts	Plate Milli-am-peres	Screen Milli-am-peres	R <sub>p</sub> , Ohms	G <sub>m</sub> , μmhos	# Factor	Load for Rated Output, Ohms	Power Output, Watts	Tube Type
Class A Amplifier	250	150	2.5	9.2	3.4	1,000,000*	4,000	—	—	—	6SG7 6SG7-GT
	250	125	1.0	11.8	4.4	900,000	4,700	—	—	—	
	100	100	1.0	8.2	3.2	250,000	4,100	—	—	—	
Class A Amplifier	250	150	1.0	10.8	4.1	900,000‡	4,900	—	—	—	6SH7 6SH7-GT
Class A Amplifier	250	100	3.0	3.0	0.8	1,000,000*	1,650	—	—	—	6SJ7 6SJ7-GT
	100	100	3.0	2.9	0.9	700,000	1,575	—	—	—	
	250	—	8.5	9.2	—	7,600	2,500	19	—	—	
Class A Amplifier	180	—	6.0	6.0	—	8,200	2,300	19	—	—	
Class A Amplifier	250	100	3.0	9.2	2.6	800,000‡	2,000	—	—	—	6SK7 6SK7-GT
	100	100	1.0	13	4.0	120,000‡	2,350	—	—	—	
Class A Amplifier ♣	250	—	2.0	2.3	—	44,000	1600	70	—	—	6SL7-GT
Class A Amplifier ♣	250	—	8.0	9.0	—	7,700	2600	20	—	—	6SN7-GT
	90	—	0	10	—	6,700	3000	20	—	—	
Class A Amplifier ♣	250	—	8.0	9.0	—	7,700‡	2,600	20	—	—	6SN7-GTA 6SN7-GTB ¶
	90	—	0	10	—	6,700‡	3,000	20	—	—	
Vertical Deflection Amplifier ♣	Max positive pulse plate voltage ⊠ = 1500 volts; max plate dissipation ⊕ = 7.5 watts; max d-c cathode current = 20 ma										
Class A Amplifier	250	—	2.0	1.1	—	85,000‡	1175	100	—	—	6SQ7 6SQ7-GT
	100	—	1.0	0.5	—	110,000‡	925	100	—	—	
Class A Amplifier	250	—	9.0	9.5	—	8,500	1,900	16	—	—	6SR7 6SR7-GT
Class A Amplifier	250	100	3.0	9.0	2.0	1,000,000‡	1,850	—	—	—	6SS7
Class A Amplifier	250	—	9.0	9.5	—	8,500	1,900	16	—	—	6ST7
Class A Amplifier ♣	250	—	2.0	2.3	—	44,000	1,600	70	—	—	6SU7-GTY
Class A Amplifier	250	150	1.0	7.5	2.8	1,500,000‡	3,600	—	—	—	6SV7
	100	100	1.0	3.7	1.4	700,000‡	2,600	—	—	—	
Class A Amplifier	250	—	3.0	1.0	—	58,000	1,200	70	—	—	6SZ7
Class A Amplifier	80	—	R <sub>k</sub> = 18 150	—	—	1,860‡	7,000	13	—	—	6T4
Tuning Indicator	Plate voltage = 250 thru 1 meg, target voltage = 250 (E <sub>g</sub> = -22 volts for max illumination) (E <sub>g</sub> = 0 volts for min illumination)										
Class A Amplifier	250	—	3.0	1.2	—	62,000	1,050	65	—	—	6T7-G
Class A Amplifier	250	—	3.0	1.0	—	58,000‡	1,200	70	—	—	6T8 6T8-A ¶
	100	—	1.0	0.8	—	54,000‡	1,300	70	—	—	

‡ Approximate.

▲ Without external shield.

† Zero signal.

‡ Grids 3 and 5 are screen. Grid 4 is signal-input grid.

# Conversion transconductance.

♣ Maximum.

♦ Grids 2 and 4 are screen. Grid 3 is signal-input grid.

\* Screen supply voltage.

⊠ Absolute maximum rating.

‡ Plate-to-plate.

♣ Per section.

♦ Design maximum rating.

⊕ For both sections.

\* Minimum.

¶ Heater warm-up time controlled for series-string service.

‡ Plate supply voltage.

‡ Input plate.

§ — The duration of the pulse voltage must not exceed 15 percent of one scanning cycle.

1— Section 1.

2— Section 2.

⊠ — A resistor of 3 ohms must be put in series with heater.

Tube Type	Classification by Construction	Base Connections	Out-line Dwg	Filament Volts	Filament Amp	Max Plate Watts	Max Plate Volts	Max Screen Volts	Capacitance in Micromicrofarads		
									Input	Out-put	Grid-plate
<i>6U3</i>	Half-Wave High-Vacuum Rectifier	9BM	6-4	6.3	0.9	—	Tube Voltage Drop: 16 v at 180 ma d-c				
<i>6U4-GT</i>	Half-Wave High-Vacuum Rectifier	4CG	9-13	6.3	1.2	—	Tube Voltage Drop: 21 v at 250 ma d-c				
<i>6U5</i>	Electron-Ray Indicator	6R	9-26	6.3	0.3	—	285	Max target voltage = 285 Min target voltage = 125			
<i>6U6-GT</i>	Beam Power Amplifier	7AC	9-11	6.3	0.75	11	200	135	—	—	—
<i>6U7-G</i>	Remote-Cutoff RF Pentode	7R	12-4	6.3	0.3	2.25	300	100	5.0	9.0	0.007 ♣
<i>6U8</i> <i>6U8-A</i> ¶	Triode-Pentode	9AE	6-2	6.3	0.45	2.8	300	150	Pentode Section		
						2.7	300	—	Triode Section		
<i>6V3</i> <i>6V3-A</i>	Half-Wave High-Vacuum Rectifier	9BD	6-7 T-X	6.3	1.75	— 2.7	Tube Voltage Drop: 19 v at 250 ma d-c				
<i>6V4</i>	Full-Wave, High-Vacuum Rectifier	9M	6-4	6.3	0.6	—	Tube Voltage Drop: 20 v at 45 ma d-c ♣				
<i>6V5-GT</i>	Beam Power Amplifier	6AO	9-11	6.3	0.45	12	315	285	—	—	—
<b>6V6</b>	Beam Power Amplifier	7AC	8-6	6.3	0.45	12	315	285	Single Tube		
									2 Tubes, Push-pull		
<i>6V6-GT</i> <i>6V6-GTA</i> ¶	Beam Power Amplifier	7AC	9-11 or 9-41	6.3	0.45	12	315	285	Single Tube		
						9.0	315	—	2 Tubes, Push-Pull Triode Connection (G <sub>2</sub> & P tied)		
<i>6V7-G</i>	Duplex-Diode Medium-Mu Triode	7V	12-8	6.3	0.3	—	250	—	2.0	3.5	1.7
<i>6V8</i>	Triple-Diode, High-Mu Triode	9AH	6-2	6.3	0.45	1.0	300	—	—	—	—
<i>6W2</i>	Half-Wave High-Voltage Rectifier	6X2	T-X	6.3	0.08	—	—	—	—	—	—
<i>6W4-GT</i>	Half-Wave High-Vacuum Rectifier	4CG	9-11 or 9-41	6.3	1.2	3.5	Tube Voltage Drop: 21 v at 250 ma d-c				
<i>6W5-G</i>	Full-Wave High-Vacuum Rectifier	6S	12-7	6.3	0.9	—	Tube Voltage Drop: 24 v at 90 ma d-c ♣				

Metal tubes are shown in bold-face type, miniature tubes in *italics*.

♣ Subminiature type.

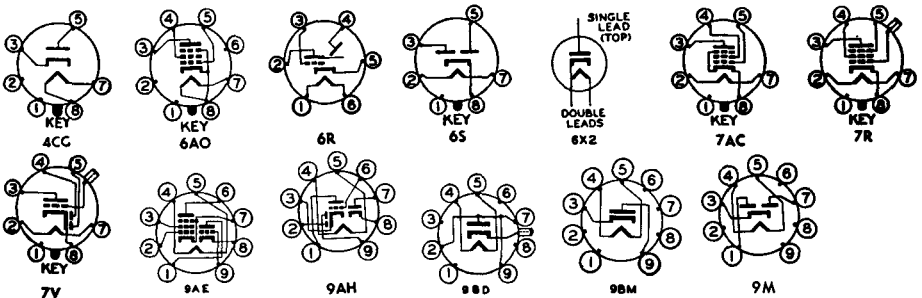

Service	Plate Volts	Screen Volts	Neg Grid Volts	Plate Milli-am-peres	Screen Milli-am-peres	R <sub>p</sub> , Ohms	G <sub>m</sub> , μmhos	μ Fac-tor	Load for Rated Out-put, Ohms	Power Out-put, Watts	Tube Type
TV Damp-er Service;	Max d-c output current = 180 ma; max peak inverse voltage = 4,000 volts; max peak current = 400 ma										6U3
Half-Wave Rectifier TV Damp-er Service;	Max d-c output current = 125 ma; max peak inverse voltage = 1250 volts; rms supply voltage = 350 volts; max peak current = 600 ma Max d-c output current = 125 ma; max peak inverse voltage ⊠ = 3850 volts; max peak current = 600 ma										6U4-GT
Tuning Indicator	Plate voltage = 250 thru 1 meg, target voltage = 250 (E <sub>g</sub> = -22 volts, shadow = 0°) (E <sub>g</sub> = 0 volt, shadow = 90°, plate current = 0.24 ma, target current ‡ = 4 ma)										6U5
Class A Amplifier	200	135	14.0	55†	3.0†	20,000	6,200	—	3,000	5.5	6U6-GT
Class A Amplifier	250	100	3.0	8.2	2.0	800,000§	1,600	—	—	—	6U7-G
Class A Amplifier	250	110	R <sub>k</sub> = 68	10	3.5	400,000§	5,200	—	—	—	6U8 6U8-A¶
Class A Amplifier	150	—	R <sub>k</sub> = 56	18	—	5,000§	8,500	40	—	—	
TV Damp-er Service;	Max d-c output current = 135 ma; max peak inverse voltage ⊠ = 6000 volts; max peak current = 800 ma										6V3 6V3-A
Full-Wave Rectifier	Max d-c output current = 90 ma; rms supply voltage per plate = 350 volts										6V4
Class A Amplifier	315 250	225 250	13 12.5	34† 45†	2.2† 4.5†	77,000§ 52,000§	3,750 4,100	— —	8,500 5,000	5.5 4.5	6V5-GT
Class A Amplifier	315 250	225 250	13 12.5	34† 45†	2.2† 4.5†	80,000§ 50,000§	3,750 4,100	— —	8,500 5,000	5.5 4.5	6V6
Class AB <sub>1</sub> Amplifier	180 285	180 285	8.5 19	29† 70†	3† 4†	50,000§ 70,000§	3,700 3,600	— —	5,500 8,000†	2.0 14	
Class A Amplifier	315 250	225 250	13 12.5	34† 45†	2.2† 4.5†	80,000§ 50,000§	3,750 4,100	— —	8,500 5,000	5.5 4.5	6V6-GT 6V6-GTA¶
Class AB <sub>1</sub> Amplifier	180 285	180 285	8.5 19	29† 70†	3.0† 4.0†	50,000§ —	3,700 —	— —	5,500 8,000†	2.0 14	
Class AB <sub>1</sub> Amplifier	250	250	15	70†	5.0†	—	—	—	10,000†	10	
Vertical Deflection Amplifier	250	—	12.5	49.5	—	1,960§	5,000	9.8	—	—	
	Max positive pulse plate voltages ⊠ = 1200 volts; max d-c cathode current = 35 ma										
Class A Amplifier	250	—	20	8.0	—	7,500	1,100	8.3	20,000	0.350	6V7-G
Class A Amplifier	250 100	— —	3.0 1.0	1.0 0.8	— —	58,000§ 54,000§	1,200 1,300	70 70	— —	— —	6V8
TV Flyback Rectifiers	Max d-c output current = 0.5 ma; max peak inverse voltage ⊠ = 25,000 volts										6W2
TV Damp-er Service;	Max d-c output current = 125 ma; max peak inverse voltage ⊠ = 3850 volts; max peak current = 750 ma										6W4-GT
Full-Wave Rectifier	Max d-c output current = 90 ma; max peak inverse voltage = 1250 volts; max rms supply voltage per plate = 325 volts; max peak current per plate = 270 ma										6W5-G

§ Approximate.

▲ Without external shield.

† Zero signal.

♦ Grids 3 and 5 are screen. Grid 4 is signal-input grid.

# Conversion transconductance.

◆ Maximum.

♥ Grids 2 and 4 are screen. Grid 3 is signal-input grid.

✱ Screen supply voltage.

⊠ Absolute maximum rating.

† Plate-to-plate.

◆ Per section.

◆ Design maximum rating.

⊕ For both sections.

\* Minimum.

¶ Heater warm-up time controlled for series-string service.

‡ Plate supply voltage.

|| Input plate.

— The duration of the pulse voltage must not exceed 15 percent of one scanning cycle.

1— Section 1.

2— Section 2.

⊖ A resistor of 3 ohms must be put in series with heater.

Tube Type	Classification by Construction	Base Connections	Outline Dwg	Fila-ment Volts	Fila-ment Amp	Max Plate Watts	Max Plate Volts	Max Screen Volts	Capacitance in Micromicrofarads		
									Input	Out-put	Grid-plate
6W6-GT	Beam Power Amplifier	7AC	9-11 or 9-41	6.3	1.2	10 7.5	300 300	150 —	Pentode Connection Triode Connection (G <sub>2</sub> & P tied)		
6W7-G	Sharp-Cutoff Pentode	7R	12-8	6.3	0.15	0.5	300	300	5.0	8.5	0.007 ♣
<i>6X2</i>	Half-Wave High-Voltage Rectifier	6X2	T-X	6.3	0.09	—	—	—	—	—	—
<i>6X4</i>	Full-Wave High-Vacuum Rectifier	5BS	5-3	6.3	0.6	—	Tube Voltage Drop: ♣ 22 v at 70 ma d-c				
<b>6X5</b> <i>6X5-GT</i>	Full-Wave High-Vacuum Rectifier	6S	8-6 9-11	6.3	0.6	—	Tube Voltage Drop: ♣ 22 v at 70 ma d-c				
<i>6X8</i>	Triode-Pentode Converter	9AK	6-2	6.3	0.45	2.0	250	250	Pentode Section		
<i>6X8-A</i> ¶						1.5	250	—	Triode Section		
6Y3-G	Half-Wave High-Voltage Rectifier	4AC	12-8	6.3	0.7	—	—	—	—	—	—
6Y6-G 6Y6-GA 6Y6-GT	Beam Power Amplifier	7AC	14-3 T-X 9-11	6.3	1.25	12.5	200	135	15.0	11.0	0.7
6Y7-G	Twin-Triode Power Amplifier	8B	12-7	6.3	0.6	11.5	250	—	Both Sections in Push-pull		
6Z5	Full-Wave High-Vacuum Rectifier	6K	12-5	{6.3 12.6	{0.8 0.4	—	—	—	—	—	—
6Z7-G	Twin-Triode Power Amplifier	8B	12-7	6.3	0.3	4.0	180	—	Both Sections in Push-pull		
6ZY5-G	Full-Wave High-Vacuum Rectifier	6S	12-7	6.3	0.3	—	Tube Voltage Drop: ♣ 18 v at 40 ma d-c				
7A4	Medium-Mu Triode	5AC	9-30	6.3	0.3	2.5	300	—	3.4	3.0	4.0
7A5	Beam Power Amplifier	6AA	9-31	6.3	0.75	5.5	125	125	—	—	—
7A6	Twin Diode	7AJ	9-30	6.3	0.15	—	Tube Voltage Drop: ♣ 11 v at 16 ma d-c				
7A7	Remote-Cutoff RF Pentode	8V	9-30	6.3	0.3	4.0	250	100	6.0	7.0	0.005 ♣
7A8	Octode Converter	8U	9-30	6.3	0.15	1.0	300	100	Osc I <sub>g1</sub> = 0.4 ma R <sub>g1</sub> = 50,000 ohms		
7AB7	Sharp-Cutoff RF Pentode	8BO	9-32	6.3	0.15	1.2	300	150	3.5	4.0	0.06 ♣

Metal tubes are shown in bold-face type, miniature tubes in *italics*.      ¶ Subminiature type.

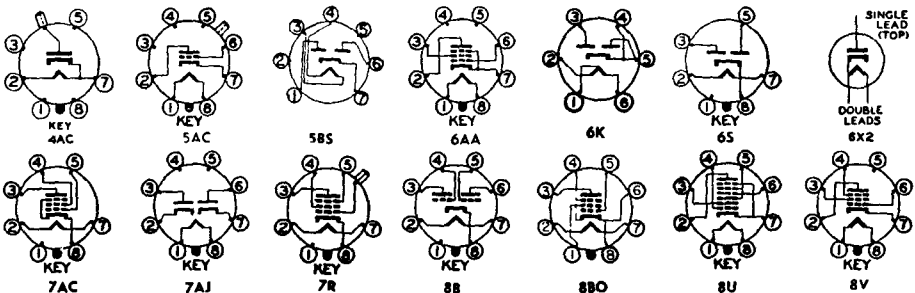

Service	Plate Volts	Screen Volts	Neg Grid Volts	Plate Milli-am-peres	Screen Milli-am-peres	R <sub>p</sub> , Ohms	G <sub>m</sub> , μmhos	μ Factor	Load for Rated Output, Ohms	Power Output, Watts	Tube Type
Class A Amplifier Vertical Deflection Amplifier	200	125	R <sub>k</sub> = 180	46†	2.2†	28,000§	8,000	—	4,000	3.8	6W6-GT
	110	110	7.5	49†	4.0†	13,000§	8,000	—	2,000	2.1	
	225	—	30	22	—	1,600§	3,800	6.2	—	—	
Max positive pulse plate voltage, $E_c = 1200$ volts; max d-c cathode current = 60 ma											
Class A Amplifier	250	100	3.0	2.0	0.5	1,500,000§	1,225	—	—	—	6W7-G
TV Flyback Rectifier <sub>3</sub>	Max d-c output current = 0.2 ma; max peak inverse voltage = 17,000 volts; max peak current = 80 ma										6X2
Full-Wave Rectifier	Max d-c output current = 70 ma; max peak inverse voltage = 1250 volts; rms supply voltage per plate = 325 volts; max peak current per plate = 210 ma										6X4
Full-Wave Rectifier	Max d-c output current = 70 ma; max peak inverse voltage = 1250 volts; rms supply voltage per plate = 325 volts; max peak current per plate = 210 ma										6X5 6X5-GT
Class A Amplifier	250	150	R <sub>k</sub> = 200	7.7	1.6	750,000§	4,600	—	—	—	6X8
Class A Amplifier	100	—	R <sub>k</sub> = 100	8.5	—	6,900§	5,800	40	—	—	6X8-A¶
Half-Wave Rectifier	Max d-c output current = 7.5 ma; max peak inverse voltage = 14,000 volts; max rms supply voltage = 5,000 volts; max peak current = 100 ma										6Y3-G
Class A Amplifier	200	135	14	61†	2.2§†	18,300§	7,100	—	2,600	6.0	6Y6-G 6Y6-GA 6Y6-GT
Class B Amplifier	250	—	0	5.3†	—	—	—	—	14000‡	8.0§	6Y7-G
Full-Wave Rectifier	Max d-c output current = 60 ma; max peak inverse voltage = 1500 volts										6Z5
Class B Amplifier	180	—	0	4.2†	—	Input signal = 0.320 watts		12000‡	4.2	—	6Z7-G
Full-Wave Rectifier	Max d-c output current = 40 ma; max peak inverse voltage = 1250 volts; max rms supply voltage per plate = 325 volts; max peak current per plate = 120 ma										6ZY5-G
Class A Amplifier	250	—	8.0	9.0	—	7,700§	2,600	20	—	—	7A4
Class A Amplifier	90	—	0	10	—	6,700§	3,000	20	—	—	7A5
Class A Amplifier	110	110	7.5	40†	3.0†	16,000§	5,800	—	2,500	1.5	7A5
Half-Wave Rectifier	Max d-c output current per plate = 8 ma; max rms supply voltage per plate = 150 volts; max peak current per plate = 45 ma										7A6
Class A Amplifier	250	100	3.0	9.2	2.6	800,000	2,000	—	—	—	7A7
Converter	250	100	3.0	3.0	3.2	700,000§	550 #	E <sub>c2</sub> (Osc Plate) = 250 thru 20,000 ohms I <sub>c2</sub> = 4.2 ma			7A8
Class A Amplifier	250	100	2.0	4.0	1.3	500,000§	1,800	—	—	—	7AB7

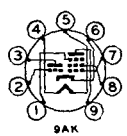

- ‡ Approximate.
- ▲ Without external shield.
- † Zero signal.
- ◆ Grids 3 and 5 are screen. Grid 4 is signal-input grid.
- # Conversion transconductance.
- ⊠ Maximum.
- ♥ Grids 2 and 4 are screen. Grid 3 is signal-input grid.
- \* Screen supply voltage.
- ⊞ Absolute maximum rating.
- ‡ Plate-to-plate.
- ◆ Per section.
- ⊠ Design maximum rating.
- ⊞ For both sections.
- \* Minimum.
- ¶ Heater warm-up time controlled for series-string service.
- ⊞ Plate supply voltage.
- ‡ Input plate.
- ‡ The duration of the pulse voltage must not exceed 15 percent of one scanning cycle.
- 1—Section 1.
- 2—Section 2.
- 4—A resistor of 3 ohms must be put in series with heater.

Tube Type	Classification by Construction	Base Connections	Out-line Dwg	Fila-ment Volts	Fila-ment Amp	Max Plate Watts	Max Plate Volts	Max Screen Volts	Capacitance in Micromicrofarads		
									Input	Out-put	Grid-plate
7AD7	Power Amplifier Pentode	8V	9-31	6.3	0.6	10	300	150	11.5	7.5	0.03 ♣
7AF7	Medium-Mu Twin Triode	8AC	9-30	6.3	0.3	2.5♣	300	—	2.2	1.6	2.3 ♣
7AG7	Sharp-Cutoff RF Pentode	8V	9-30	6.3	0.15	2.0	300	300	7.0	6.0	0.005 ♣
7AH7	Remote-Cutoff RF Pentode	8V	9-30	6.3	0.15	2.0	300	300	7.0	6.5	0.005 ♣
7AJ7	Sharp-Cutoff RF Pentode	8V	9-30	6.3	0.3	1.0	300	100	6.0	6.5	0.007 ♣
7AK7	Sharp-Cutoff Dual-Control Pentode	8V	9-31	6.3	0.8	8.5	200	100	12.0	9.5	0.7
7AN7	Twin Triode	9DD	6-2	7.0	0.3	2.0♣	180	—	2.3 <sub>1</sub> ▲	0.45 <sub>1</sub> ▲	1.2 <sub>1</sub> ▲ 2.3 <sub>2</sub> ▲
7AU7	Medium-Mu Twin Triode	9A	6-2	{7.0 3.5}	{0.3 0.6}	2.75 ♣	300	—	1.8	2.0	1.5
7B4	High-Mu Triode	5AC	9-30	6.3	0.3	—	300	—	3.6	3.4	1.6
7B5	Power Amplifier Pentode	6AE	9-31	6.3	0.4	8.5	315	285	—	—	—
7B6	Duplex-Diode High-Mu Triode	8W	9-30	6.3	0.3	0.5	300	—	—	—	—
7B7	Remote-Cutoff RF Pentode	8V	9-30	6.3	0.15	2.25	300	100	5.0	6.0	0.004 ♣
7B8	Pentagrid Converter	8X♣	9-30	6.3	0.3	1.0	300	100	Osc I <sub>g1</sub> = 0.4 ma R <sub>g1</sub> = 50,000 ohms		
7C4	High-Frequency Diode	4AH	9-30	6.3	0.15	—	Tube Voltage Drop: 11 v at 10 ma d-c				
7C5	Beam Power Amplifier	6AA	9-31	6.3	0.45	12	315	285	—	—	—
7C6	Duplex-Diode High-Mu Triode	8W	9-30	6.3	0.15	0.6	300	—	—	—	—
7C7	Sharp-Cutoff Pentode	8V	9-30	6.3	0.15	1.0	300	100	5.5	6.5	0.007 ♣
7E5	High-Frequency Triode	8BN	9-30	6.3	0.15	4.0	250	—	3.6	2.8	1.5
7E6	Duplex-Diode Medium-Mu Triode	8W	9-30	6.3	0.3	2.5	250	—	—	—	—

Metal tubes are shown in bold-face type, miniature tubes in italics.      ©Subminiature type.

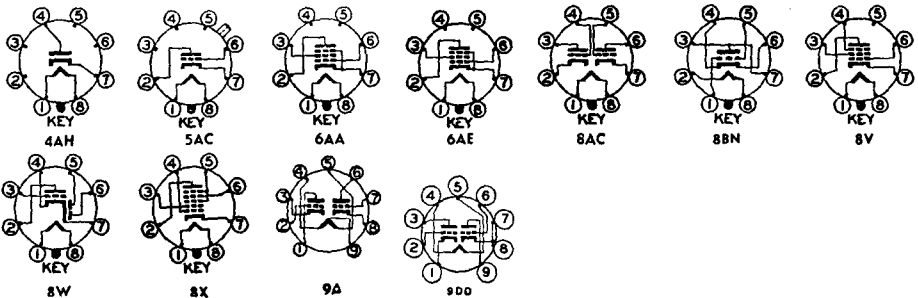

Service	Plate Volts	Screen Volts	Neg Grid Volts	Plate Milli- am- peres	Screen Milli- am- peres	R <sub>p</sub> , Ohms	G <sub>m</sub> , μmhos	μ Fac- tor	Load for Rated Out- put, Ohms	Power Out- put, Watts	Tube Type
Class A Amplifier	300	150	R <sub>k</sub> = 68	28	7.0	300,000§	9,500	—	—	—	7AD7
Class A Amplifier ♠	250	—	10	9.0	—	7,600	2,100	16	—	—	7AF7
Class A Amplifier	250	250	R <sub>k</sub> = 250	6.0	2.0	1,000,000*	4,200	—	—	—	7AG7
Class A Amplifier	250	250	R <sub>k</sub> = 250	6.8	1.9	1,000,000§	3,300	—	—	—	7AH7
Class A Amplifier	100 250	100 100	1.0 3.0	5.7 2.2	1.8 0.7	400,000§ 1,000,000§	2,275 1,575	—	—	—	7AJ7
Class A Amplifier	150 150 150	90 90 90	0 11 0	40 2.5 ♣ 2.0 ♣	21 0.45 60 ♣	11,500§ — —	6,000 — —	E <sub>c3</sub> = 0 volts E <sub>c3</sub> = 0 volts E <sub>c3</sub> = 9.5 volts			7AK7
Class A Amplifier ♠	90	—	1.5	12	—	4,000	6,000	24	—	—	7AN7
Class A Amplifier ♠	250 100	— —	8.5 0	10.5 11.8	—	7,700§ 6,500§	2,200 3,100	17 20	—	—	7AU7¶
Vertical Deflection Amplifier ♠	Max positive pulse plate voltage; □ = 1,200 volts; max d-c cathode current = 20 ma										
Class A Amplifier	250	—	2.0	0.9	—	66,000	1,500	100	—	—	7B4
Class A Amplifier	315 250	250 250	21 18	25.5† 32†	4.0† 5.5†	75,000 68,000	2,100 2,300	— —	9,000 7,600	4.5 3.4	7B5
Class A Amplifier	250 100	— —	2.0 1.0	0.9 0.4	—	91,000§ 110,000§	1,100 900	100 100	— —	— —	7B6
Class A Amplifier	250 100	100 100	3.0 3.0	8.5 8.2	1.7 1.8	750,000 300,000	1,750 1,675	— —	— —	— —	7B7
Converter	250	100	3.0	3.5	2.7	360,000§	550 #	E <sub>c2</sub> (Osc Plate) = 250 thru 20,000 ohms I <sub>c2</sub> = 4.0 ma			7B8
Half-Wave Rectifier	Max d-c output current = 5.0 ma; max rms supply voltage = 117 volts										
Class A Amplifier	315 250	225 250	13.0 12.5	34† 45†	2.2† 4.5†	77,000§ 52,000§	3,750 4,100	—	8,500 5,000	5.5 4.5	7C5
Class A Amplifier	250 100	— —	1.0 0	1.3 1.0	—	100,000§ 100,000§	1,000 850	100 85	—	—	7C6
Class A Amplifier	250	100	3.0	2.0	0.5	2,000,000§	1,300	—	—	—	7C7
Class A Amplifier	180	—	3.0	5.5	—	12,000	3,000	36	—	—	7E5
Class A Amplifier	250	—	9.0	9.5	—	8,500	1,900	16	—	—	7E6

§ Approximate.

▲ Without external shield.

† Zero signal.

♠ Grids 3 and 5 are screen. Grid 4 is signal-input grid.

# Conversion transconductance.

♣ Maximum.

♥ Grids 2 and 4 are screen. Grid 3 is signal-input grid.

\* Screen supply voltage.

□ Absolute maximum rating.

† Plate-to-plate.

♠ Per section.

♣ Design maximum rating.

♠ For both sections.

\* Minimum.

¶ Heater warm-up time controlled for series-string service.

‡ Plate supply voltage.

§ Input plate.

‡ The duration of the pulse voltage must not exceed 15 percent of one scanning cycle.

1—Section 1.

2—Section 2.

4—A resistor of 3 ohms must be put in series with heater.

Tube Type	Classification by Construction	Base Connections	Out-line Dwg	Filament Volts	Filament Amp	Max Plate Watts	Max Plate Volts	Max Screen Volts	Capacitance in Micromicrofarads		
									Input	Out-put	Grid-plate
7E7	Duplex-Diode Remote-Cutoff Pentode	8AE	9-30	6.3	0.3	2.0	250	100	4.6	4.6	0.005 ♣
7F7	High-Mu Twin Triode	8AC	9-30	6.3	0.3	1.0 ♣	250	—	—	—	—
7F8	High-Frequency Twin Triode	8BW	9-32	6.3	0.3	3.5 ♣ 3.5 ⊕	300	—	2.8	1.4	1.6
7G7	Sharp-Cutoff Pentode	8V	9-30	6.3	0.45	1.5	250	100	9.0	7.0	0.007 ♣
7G8	Sharp-Cutoff Twin Tetrode	8BV	9-32	6.3	0.3	1.5 ♣	300	150	3.4	2.6	0.15 ♣
7H7	Semi-Remote-Cutoff RF Pentode	8V	9-30	6.3	0.3	2.5	300	150	8.0	7.0	0.004 ♣
7J7	Triode Heptode Converter	8BL	9-30	6.3	0.3	0.5 1.25	300 150	100	Osc $I_{g1}$ = 0.4 ma $R_{g1}$ = 50,000 ohms Triode Section		
7K7	Duplex-Diode High-Mu Triode	8BF	9-30	6.3	0.3	—	250	—	—	—	—
7L7	Sharp-Cutoff Pentode	8V	9-30	6.3	0.3	4.0	300	125	8.0	6.5	0.01 ♣
7N7	Medium-Mu Twin Triode	8AC	9-31	6.3	0.6	2.5 ♣	300	—	—	—	—
7Q7	Pentagrid Converter	8AL ▼	9-30	6.3	0.3	1.0	300	100	Osc $I_{g1}$ = 0.5 ma $R_{g1}$ = 20,000 ohms		
7R7	Duplex-Diode Remote-Cutoff Pentode	8AE	9-30	6.3	0.3	2.0	250	125	5.6	5.3	0.004 ♣
7S7	Triode-Heptode Converter	8BL	9-30	6.3	0.3	0.6	300	100	Osc $I_{g1}$ = 0.4 ma $R_{g1}$ = 50,000 ohms		
7T7	Sharp-Cutoff RF Pentode	8V	9-30	6.3	0.3	3.0	300	150	7.5	5.5	0.005
7V7	Sharp-Cutoff RF Pentode	8V	9-30	6.3	0.45	4.0	300	150	—	—	—
7W7	Sharp-Cutoff RF Pentode	8BJ	9-30	6.3	0.45	4.0	300	150	—	—	—
7X6	High-Vacuum Rectifier-Doubler	7AJ	9-31	6.3	1.2	—	Tube Voltage Drop: ♣ 22 v at 150 ma d-c				
7X7	Duplex-Diode High-Mu Triode	8BZ	9-31	6.3	0.3	—	300	—	—	—	—
7Y4	Full-Wave High-Vacuum Rectifier	5AB	9-30	6.3	0.5	—	Tube Voltage Drop: ♣ 22 v at 70 ma d-c				
7Z4	Full-Wave High-Vacuum Rectifier	5AB	9-31	6.3	0.9	—	Tube Voltage Drop: ♣ 40 v at 100 ma				

Metal tubes are shown in bold-face type, *miniature tubes in italics.*

♣Subminiature type.

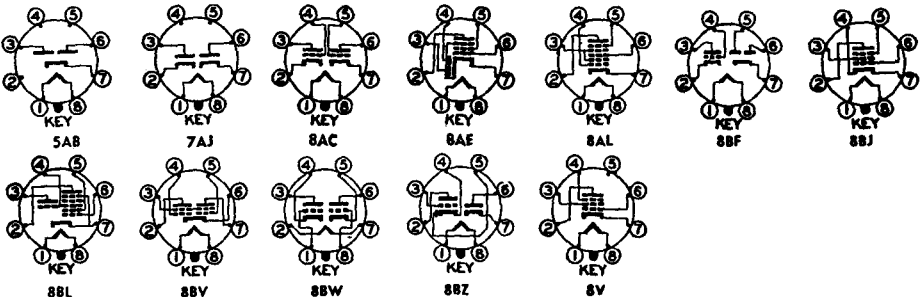



Service	Plate Volts	Screen Volts	Neg Grid Volts	Plate Milli-amperes	Screen Milli-amperes	R <sub>p</sub> , Ohms	G <sub>m</sub> , μmhos	μ Factor	Load for Rated Output, Ohms	Power Output, Watts	Tube Type
Class A Amplifier	250	100	3.0	7.5	1.6	700,000§	1,300	—	—	—	7E7
Class A Amplifier ♠	250	—	2.0	2.3	—	44,000§	1,600	70	—	—	7F7
Class A Amplifier ♠	250	—	R <sub>k</sub> = 500	6.0	—	—	3,300	48	—	—	7F8
Class A Amplifier	250	100	2.0	6.0	2.0	800,000§	4,500	—	—	—	7G7
Class A Amplifier ♠	250	100	2.5	4.5	0.8	225,000§	2,100	—	—	—	7G8
Class A Amplifier	250	150	R <sub>k</sub> = 180	10	3.2	800,000§	4,000	—	—	—	7H7
	100	100	1.5	7.5	2.6	350,000§	4,000	—	—	—	
Converter	250	100	3.0	1.4	2.8	1,500,000§	290 #	E <sub>b</sub> (Triode Osc) = 250 thru 20,000 ohms I <sub>b</sub> (Triode) = 5.0 ma			7J7
Class A Amplifier	250	—	2.0	2.3	—	44,000	1,600	70	—	—	7K7
Class A Amplifier	250	100	1.5	4.5	1.5	1,000,000§	3,100	—	—	—	7L7
Class A Amplifier ♠	250	—	8.0	9.0	—	7,700	2,600	20	—	—	7N7
Converter	250	100	2.0	3.5	8.5	1,000,000§	550 #	—	—	—	7Q7
Class A Amplifier	250	100	1.0	5.7	2.1	1,000,000§	3,200	—	—	—	7R7
	100	100	1.0	5.5	2.2	350,000§	3,000	—	—	—	
Converter	250	100	2.0	1.8	3.0	1,250,000§	525 #	E <sub>b</sub> (Triode Osc) = 250 thru 20,000 ohms I <sub>b</sub> (Triode) = 5.0 ma			7S7
Class A Amplifier	250	150	1.0	10.8	4.1	900,000	4,900	—	—	—	7T7
Class A Amplifier	300	150	R <sub>k</sub> = 160	10	3.9	300,000§	5,800	—	—	—	7V7
Class A Amplifier	300	150	R <sub>k</sub> = 160	10	3.9	300,000	5,800	—	—	—	7W7
Rectifier or Doubler	Max d-c output current per plate = 75 ma; max peak inverse voltage = 700 volts; rms supply voltage per plate = 235 volts; max peak current per plate = 450 ma										7X6
Class A Amplifier	250	—	1.0	1.9	—	67,000	1,500	100	—	—	7X7
Full-Wave Rectifier	Max d-c output current = 70 ma; max peak inverse voltage = 1250 volts; max rms supply voltage per plate = 325 volts; max peak current per plate = 210 ma										7Y4
Full-Wave Rectifier	Max d-c output current = 100 ma; max peak inverse voltage = 1,250 volts; max rms supply voltage per plate = 325 volts; max peak current per plate = 300 ma										7Z4

§ Approximate.

▲ Without external shield.

† Zero signal.

♦ Grids 3 and 5 are screen. Grid 4 is signal-input grid.

# Conversion transconductance.

♣ Maximum.

♥ Grids 2 and 4 are screen. Grid 3 is signal-input grid.

✱ Screen supply voltage.

☐ Absolute maximum rating.

‡ Plate-to-plate.

♠ Per section.

⊕ Design maximum rating.

⊕ For both sections.

\* Minimum.

¶ Heater warm-up time controlled for series-string service.

§ Plate supply voltage.

|| Input plate.

⊖ The duration of the pulse voltage must not exceed 15 percent of one scanning cycle.

1—Section 1.

2—Section 2.

⊖ A resistor of 3 ohms must be put in series with heater.

Tube Type	Classification by Construction	Base Connections	Out-line Dwg	Fila-ment Volts	Fila-ment Amp	Max Plate Watts	Max Plate Volts	Max Screen Volts	Capacitance in Micromicrofarads		
									Input	Out-put	Grid-plate
<b>8AU8</b> ¶	Triode-Pentode	9DX	6-3	8.4	0.45	3.0 2.5	300 300	150 —	Pentode Section Triode Section		
<b>8AW8-A</b> ¶	Triode-Pentode	9DX	6-3	8.4	0.45	3.25 1.0	300 300	150 —	Pentode Section Triode Section		
<b>8BA8-A</b> ¶	Triode-Pentode	9DX	6-3	8.4	0.45	3.25 2.0	300 300	150 —	Pentode Section Triode Section		
<b>8BH8</b> ¶	Triode-Pentode	9DX	6-3	8.4	0.45	3.0 2.5	300 300	150 —	Pentode Section Triode Section		
<b>8BN8</b> ¶	Duplex-Diode High- $\mu$ Triode	9ER	6-3	8.4	0.45	1.5	300	—	3.6▲   0.32▲   2.5▲ Diode Sections		
<b>8BQ7-A</b>	High-Frequency Twin Triode	9AJ	6-2	8.4	0.3	2.0▲	250	—	2.6i	1.2i	1.2
<b>8CG7</b> ¶	Medium- $\mu$ Twin Triode	9AJ	6-3	8.4	0.45	3.5▲ 5.0⊕	300	—	2.3▲	2.2▲	4.0▲
<b>8CM7</b> ¶	Medium- $\mu$ Twin Triode	9ES	6-3	8.4	0.45	1.25 5.0	500 500	— —	Section 1 (Pins 3, 6, 7) Section 2 (Pins 1, 8, 9)		
<b>8CN7</b> ¶	Duplex-Diode Triode	9EN	6-2	{ 8.4 4.2	{ 0.225 0.45	1.0	300	—	1.5▲   0.5▲   1.8▲ Diode Sections		
<b>8CS7</b> ¶	Twin Triode	9EF	6-3	8.4	0.45	1.25 6.5	500 500	— —	Section 1 (Pins 6, 7, 8) Section 2 (Pins 1, 3, 9)		
<b>8SN7-GTB</b> ¶	Medium- $\mu$ Twin Triode	8BD	9-11 or 9-41	8.4	0.45	5.0▲ 7.5⊕	450	—	2.2i▲ 2.6i▲	0.7▲	4.0i▲ 3.8i▲
<b>9AK8</b>	Triple-Diode Triode	9E	6-3	9.5	0.3	1.0	250	—	Triode Section Diode Sections		

Metal tubes are shown in bold-face type, miniature tubes in italics.

⊕Subminiature type.

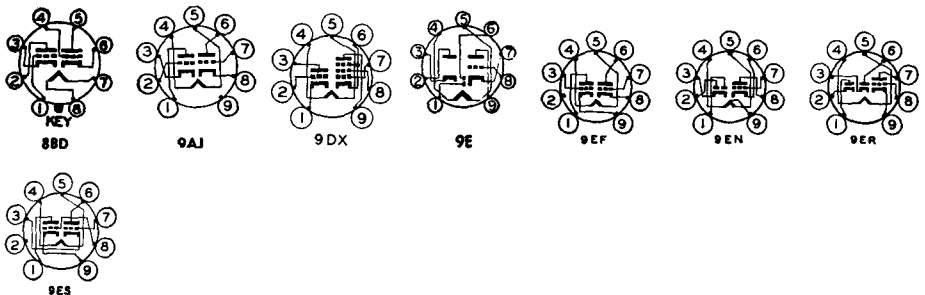

Service	Plate Volts	Screen Volts	Neg Grid Volts	Plate Milli-amperes	Screen Milli-amperes	$R_p$ , Ohms	$G_m$ , $\mu$ mbos	$\mu$ Factor	Load for Rated Output, Ohms	Power Output, Watts	Tube Type
Class A Amplifier Class A Amplifier	200	125	$R_k = 82$	15	3.4	150,000 $\S$	7,000	—	—	—	8A8 $\ddagger$
	150	—	$R_k = 150$	9.0	—	8,200 $\S$	4,900	40	—	—	
Class A Amplifier Class A Amplifier	200	150	$R_k = 180$	13	3.5	400,000 $\S$	9,000	—	—	—	8A8-A $\ddagger$
	65 200	150 —	0 2.0	42 4.0	12.5 —	— 17,500 $\S$	— 4,000	— 70	— —	— —	
Class A Amplifier Class A Amplifier	200	150	$R_k = 180$	13	3.5	400,000 $\S$	9,000	—	—	—	8BA8-A $\ddagger$
	65 200	150 —	0 8.0	42 8.0	12.5 —	— 6,700 $\S$	— 2,700	— 18	— —	— —	
Class A Amplifier Class A Amplifier	200	125	$R_k = 82$	15	3.4	150,000 $\S$	7,000	—	—	—	8BH8 $\ddagger$
	150	—	5.0	9.5	—	5,150 $\S$	3,300	17	—	—	
Class A Amplifier Horizontal Phase Detector	250 100	—	3.0 1.0	1.6 1.5	—	28,000 $\S$ 21,000 $\S$	2,500 3,500	70 75	—	—	8BN8 $\ddagger$
	Max d-c output current $\clubsuit = 9.0$ ma; voltage drop $\clubsuit$ : 2.6 volts at 9.0 ma d-c										
Class A Amplifier $\clubsuit$	150	—	$R_k = 220$	9.0	—	5,900 $\S$	6,400	38	—	—	8BQ7-A
Class A Amplifier $\clubsuit$	250 250 90	—	8.0 12.5 0	9.0 1.3 10	—	7,700 $\S$ 6,700 $\S$	2,600 3,000	20 20	—	—	8CG7 $\ddagger$
	200	—	7.0	5.0	—	10,500 $\S$	2,000	21	—	—	
Vertical Deflection Oscillator Vertical Deflection Amplifier	250	—	8.0	20	—	4,100 $\S$	4,400	18	—	—	8CM7 $\ddagger$
	Max d-c cathode current = 15 ma Max positive pulse plate voltage $\S$ $\square = 2,200$ volts; max d-c cathode current = 20 ma										
Class A Amplifier Horizontal Phase Detector	250 100	—	3.0 1.0	1.0 0.8	—	58,000 $\S$ 54,000 $\S$	1,200 1,300	70 70	—	—	8CN7 $\ddagger$
	Max d-c output current $\clubsuit = 5.0$ ma; voltage drop $\clubsuit$ : 5 volts at 20 ma d-c										
Vertical Deflection Oscillator Vertical Deflection Amplifier	250	—	8.5	10.5	—	7,700	2,200	17	—	—	8CS7 $\ddagger$
	Max d-c cathode current = 20 ma Max positive pulse plate voltage $\S$ $\square = 2,200$ volts; max d-c cathode current = 30 ma										
Class A Amplifier $\clubsuit$ Vertical Deflection Amplifier $\clubsuit$	250 90	—	8.0 0	9.0 10	—	7,700 $\S$ 6,700 $\S$	2,600 3,000	20 20	—	—	8SN7-GTB $\ddagger$
	Max positive pulse plate voltage $\S$ $\square = 1,500$ volts; max d-c cathode current = 20 ma										
Class A Amplifier Video and Audio Detectors	250	—	3.0	1.0	—	58,000 $\S$	1,200	70	—	—	9AK8
Max d-c output current of diode 1 (pins 6 and 7) = 1.0 ma; max d-c output current of diode 2 (pins 2 and 3) and diode 3 (pins 1 and 7) = 10 ma											

$\S$  Approximate.

$\blacktriangle$  Without external shield.

$\dagger$  Zero signal.

$\ddagger$  Grids 3 and 5 are screen. Grid 4 is signal-

input grid.

$\#$  Conversion transconductance.

$\clubsuit$  Maximum.

$\heartsuit$  Grids 2 and 4 are screen. Grid 3 is signal-

input grid.

$\times$  Screen supply voltage.

$\square$  Absolute maximum rating.

$\dagger$  Plate-to-plate.

$\clubsuit$  Pe section.

$\diamond$  Design maximum rating.

$\oplus$  For both sections.

$\ast$  Minimum.

$\ddagger$  Heater warm-up time controlled for series-string service.

$\S$  Plate supply voltage.

$\parallel$  Input plate.

$\S$ —The duration of the pulse voltage must not exceed 15 percent of one scanning cycle.

$\parallel$ —Section 1.

$\parallel$ —Section 2.

$\S$ —A resistor of 3 ohms must be put in series with heater.

Tube Type	Classification by Construction	Base Connections	Out-line Dwg	Fila-ment Volts	Fila-ment Amp	Max Plate Watts	Max Plate Volts	Max Screen Volts	Capacitance in Micromicrofarads		
									Input	Out-put	Grid-plate
<i>9AQ8</i>	Twin Triode	9DE	6-2	9.0	0.3	2.5 ♣	250	—	3.0 ▲	1.2 ▲	1.5 ▲
<i>9AU7</i> ¶	Medium- $\mu$ Twin Triode	9A	6-2	{ 9.4 4.7 }	{ 0.225 0.45 }	2.75 ♣	300	—	1.8	2.0	1.5
<i>9BM5</i>	Power Amplifier Pentode	7BZ	5-3	9.5	0.3	9.0	250	250	8.0 ▲	5.5 ▲	0.5 ▲♣
<i>9BW6</i>	Beam Power Amplifier	9AM	6-3	9.45	0.3	12	315	285	—	—	—
<i>9U8</i> <i>9U8-A</i> ¶	Triode-Pentode	9AE	6-2	9.45	0.3	2.8 2.7	300 300	150 —	Pentode Section Triode Section		
10	Power Amplifier Triode	4D	T-X	7.5	1.25	12	425	—	4.0	3.0	7.0
<i>10C8</i> ¶	Triode-Pentode	9DA	6-2	10.5	0.3	2.2 ♦ 2.0 ♦ 2.5 ♦ 1.0 ♦	300 ♦ 300 ♦ 300 ♦ 300 ♦	150 ♦ — — —	Pentode Section Triode Section Pentode Section—Triode Connection Triode Section		
12A	Detector Amplifier Triode	4D	14-1	5.0 DC	0.25	—	180	—	4.0 ▲	2.0 ▲	8.5 ▲
<i>12A4</i>	Medium-Mu Triode	9AG	6-3	{ 12.6 6.3 }	{ 0.3 0.6 }	5.9	450	—	4.9 ▲	0.9 ▲	5.6 ▲
<i>12A5</i>	Power Amplifier Pentode	7F	12-5	{ 12.6 6.3 }	{ 0.3 0.6 }	8.25	180	180	—	—	—
<i>12A6</i> <i>12A6-GT</i>	Beam Power Amplifier	7AC	8-6 9-9	12.6	0.15	7.5	250	250	—	—	—
<i>12A7</i>	Half-Wave Rectifier Power Amplifier Pentode	7K	12-6	12.6	0.3	—	135	135	—	—	—
<i>12A8-G</i> <i>12A8-GT</i>	Pentagrid Converter	8A ♠	12-8 9-18	12.6	0.15	1.0	300	100	Osc $I_{g1} = 0.4$ ma $R_{g1} = 50,000$ ohms		
<i>12AB5</i>	Beam Power Amplifier	9EU	6-3	12.6	0.2	12	315	285	8.0 ▲	8.5 ▲	0.7 ▲
<i>12AC5</i>	Remote-Cutoff RF Pentode	8GW	T-X	12.6	0.1	2.0	250	150	5.0 ▲	7.0 ▲	0.002 ▲
<i>12AC6</i>	Remote-Cutoff RF Pentode	7BK	5-2	12.6	0.15	—	30	30	4.3	5.0	0.004

Metal tubes are shown in bold-face type, miniature tubes in italics.

⊙ Subminiature type.

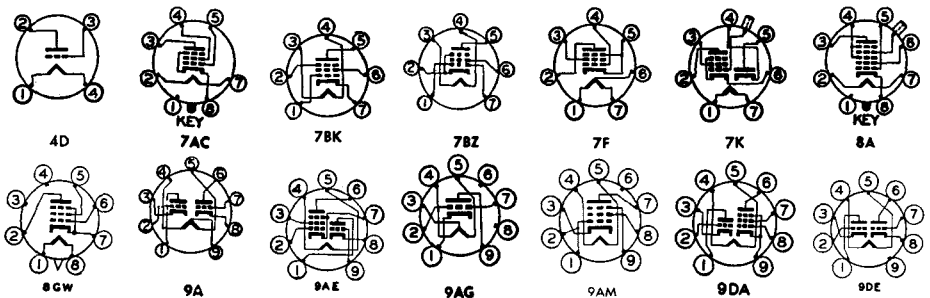

Service	Plate Volts	Screen Volts	Neg Grid Volts	Plate Milli-amperes	Screen Milli-amperes	R <sub>p</sub> , Ohms	G <sub>m</sub> , μmhos	μ Factor	Load for Rated Output, Ohms	Power Output, Watts	Tube Type
Class A Amplifier ♣	200	—	2.1	10	—	8,300§	5,800	48	—	—	9AQ8
Class A Amplifier ♣ Vertical Deflection Amplifier ♣	250 100	— —	8.5 0	10.5 11.8	—	7,700§ 6,500§	2,200 3,100	17 20	— —	— —	9AU7¶
Max positive pulse plate voltage ⊞ = 1,200 volts; max d-c cathode current = 20 ma											
Class A Amplifier	250	250	6.0	30†	3.0†	60,000§	7,000	—	7,000	3.5	9BM5
Class A Amplifier	250	250	12.5	45†	4.5†	52,000§	4,100	—	5,000	4.5	9BW6
Class A Amplifier	250	110	R <sub>k</sub> = 68	10	3.5	400,000§	5,200	—	—	—	9U8
Class A Amplifier	150	—	R <sub>k</sub> = 56	18	—	5,000§	8,500	40	—	—	9U8-A¶
Class A Amplifier	425	—	40	18†	—	5,000	1,600	8.0	10,200	1.6	10
Class A Amplifier	135	135	R <sub>k</sub> = 100	11.5	3.2	190,000§	8,000	—	—	—	10C8¶
Class A Amplifier	250	—	R <sub>k</sub> = 390	7.3	—	12,000§	4,400	53	—	—	10
Vertical Deflection Amplifier	Max positive pulse plate voltage ⊞ = 1,000 volts; max d-c cathode current ⊞ = 18 ma										
Vertical Deflection Amplifier	Max d-c cathode current ⊞ = 12 ma										
Class A Amplifier	180	—	13.5	7.7†	—	4,700	1,800	8.5	10,650	0.285	12A
Vertical Deflection Amplifier	250	—	9.0	23	—	2,500§	8,000	20	—	—	12A4
Max positive pulse plate voltage ⊞ = 1,000 volts; max d-c cathode current = 30 ma											
Class A Amplifier	180 100	180 100	25 15	45† 17†	8† 3†	35,000§ 50,000§	2,400 1,700	—	3,300 4,500	3.4 0.8	12A5
Class A Amplifier	250	250	12.5	30†	3.5†	70,000§	3,000	—	7,500	3.4	12A6 12A6-GT
Class A Amplifier	135	135	13.5	9.0†	2.5†	102,000	975	—	13,500	0.55	12A7
Max d-c output current = 30 ma; max rms supply voltage = 125 v											
Converter	250	100	3.0	3.5	2.7	360,000§	550 # E <sub>c2</sub> (Osc Plate) = 250 thru 20,000 ohms I <sub>c2</sub> = 4.0 ma				12A8-G 12A8-GT
Class A Amplifier	250 250	250 200	12.5 R <sub>k</sub> = 270	45† 33.5†	4.5† 1.6†	50,000§ —	4,100 4,000	— —	5,000 6,000	4.5 3.3	12AB5
Class A Amplifier	200	116	3.0	7.2	2.1	1,000,000§	23,750	—	—	—	12AC5
Class A Amplifier	12.6	12.6	E <sub>cct</sub> = 0	0.6	0.2	600,000§	750	R <sub>g1</sub> = 2.2 meg		—	12AC6



§ Approximate.

▲ Without external shield.

† Zero signal.

♦ Grids 3 and 5 are screen. Grid 4 is signal-input grid.

# Conversion transconductance.

♣ Maximum.

♥ Grids 2 and 4 are screen. Grid 3 is signal-input grid.

✱ Screen supply voltage.

⊞ Absolute maximum rating.

† Plate-to-plate.

♣ Per section.

⊞ Design maximum rating.

⊞ For both sections.

\* Minimum.

¶ Heater warm-up time controlled for series-string service.

‡ Plate supply voltage.

|| Input plate.

3—The duration of the pulse voltage must not exceed 15 percent of one scanning cycle.

1—Section 1.

2—Section 2.

⊞—A resistor of 3 ohms must be put in series with heater.

Tube Type	Classification by Construction	Base Connections	Out-line Dwg	Fila-ment Volts	Fila-ment Amp	Max Plate Watts	Max Plate Volts	Max Screen Volts	Capacitance in Micromicrofarads		
									Input	Out-put	Grid-plate
<i>12AD6</i>	Pentagrid Converter	7CH ▼	5-2	12.6	0.15	—	30	30	Osc. $I_{g1} = 0.075$ ma $R_{g1} = 33,000$ ohms		
<i>12AD7</i>	High- $\mu$ Twin Triode	9A	6-2	{ 12.6 6.3 }	{ 0.225 0.45 }	1.0♣	300	—	1.6▲	0.51▲ 0.45 <sub>2</sub> ▲	1.8▲
<i>12AE6</i>	Duplex-Diode Triode	7BT	5-2	12.6	0.15	—	30	—	1.8▲	1.1▲	2.0▲
									Diode Sections		
<i>12AF6</i>	RF Pentode	7BK	5-2	12.6	0.15	—	16	16	5.5▲	4.8▲	0.006♣▲
<i>12AG6</i>	Heptode	7CH ▼	5-2	12.6	0.15	—	16	16	Osc. $I_{g1} = 0.05$ ma $R_{g1} = 20,000$ ohms		
<i>12AH7-GT</i>	Medium- $\mu$ Twin Triode	8BE	9-7	12.6	0.15	1.5♣	180	—	—	—	—
<i>12AH8</i>	Triode-Heptode Converter	9BP	6-3	{ 12.6 6.3 }	{ 0.15 0.3 }	1.5 0.75	300 150	125 —	Osc. $I_{g1} = 0.2$ ma $R_{g1} = 47,000$ ohms Triode Section		
<i>12AJ6</i>	Duplex-Diode Triode	7BT	5-2	12.6	0.15	—	30	—	2.2▲	0.8▲	2.0▲
									Diode Sections		
<i>12AJ7</i>	Triode-Heptode	9CA	6-3	12.6	0.15	1.7 0.8	250 250	125 —	Heptode Section Triode Section		
<i>12AL5</i>	Twin Diode	6BT	5-1	12.6	0.15	—	Tube Voltage Drop: ♣ 10 v at 60 ma d-c				
<i>12AQ5</i>	Beam Power Amplifier	7BZ	5-3	12.6	0.225	12	250	250	8.3▲	8.2▲	0.35▲
<i>12AT6</i>	Duplex-Diode High- $\mu$ Triode	7BT	5-2	12.6	0.15	0.5	300	—	2.2	1.2	2.0
<i>12AT7</i>	High-Frequency Twin Triode	9A	6-2	{ 12.6 6.3 }	{ 0.15 0.3 }	2.5♣	300	—	2.2	1.2 <sub>1</sub> 1.5 <sub>2</sub>	1.5
<i>12AU6</i>	Sharp-Cutoff RF Pentode	7BK	5-2	12.6	0.15	3.0 3.2	300 250	150 —	Pentode Connection Triode Connection ( $G_2$ , $G_3$ , & P tied)		
<i>12AU7</i> <i>12AU7-A</i>	Medium- $\mu$ Twin Triode	9A	6-2	{ 12.6 6.3 }	{ 0.15 0.3 }	2.75♣	300	—	1.8	2.0	1.5

Metal tubes are shown in bold-face type, miniature tubes in italics.

♣Subminiature type.

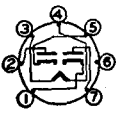

6BT



7BK

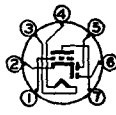

7BT



7BZ

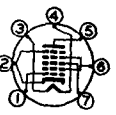

7CH

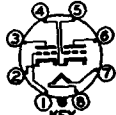

8BE

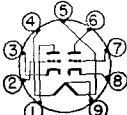

9A

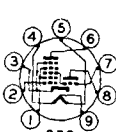

9BP

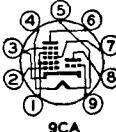

9CA

Service	Plate Volts	Screen Volts	Neg Grid Volts	Plate Milli-amperes	Screen Milli-amperes	$R_p$ , Ohms	$G_m$ , $\mu$ mhos	$\mu$ Factor	Load for Rated Output, Ohms	Power Output, Watts	Tube Type
Converter	12.6	12.6	$E_{cct3}=0$	0.34	1.27	1,000,000§	260#	$R_{g3} = 2.2$ meg	—	—	12AD6
Class A Amplifier ♣	250	—	2.0	1.25	—	62,500§	1,600	100	—	—	12AD7
Class A Amplifier AM Detector	12.6	—	0	0.75	—	15,000§	1,000	15	—	—	12AE6
Max d-c output current ♣ = 1.0 ma; voltage drop ♣: 10 volts at 2.0 ma d-c											
Class A Amplifier	12.6	12.6	$E_{cct3}=0$	0.75	0.35	300,000§	1,150	$R_{g1} = 2.2$ meg	—	—	12AF6
Converter	12.6	12.6	—	0.55	1.4	—	300#	$E_{cct3} = 0$ volts $R_{g3} = 2.2$ meg	—	—	12AG6
Class A Amplifier ♣	180	—	6.5	7.6	—	8,400	1,900	16	—	—	12AH7-GT
Converter	250	100	3.0	2.6	4.4	1,500,000	550 #	$E_b$ (Triode Osc) = 100 $I_b$ (Triode) = 5.3 ma§	—	—	12AH8
Class A Amplifier AM Detector	12.6	—	0	0.6	—	33,000	1,200	40	—	—	12AJ6
Max d-c output current ♣ = 1.0 ma; voltage drop ♣: 10 volts at 20 ma d-c											
Converter	200	119	2.3	3.7	8.1	1,000,000§	775#	—	—	—	12AJ7
	100	—	—	13.5	—	—	3,700	22	—	—	
Characteristics given are with heptode grid 3 connected to triode grid; heptode grid 3 and triode grid current = 230 $\mu$ a; heptode grid 3 and triode grid resistance = 47,000 ohms											
Half-Wave Rectifier	Max d-c output current per plate = 9 ma; max peak inverse voltage = 330 volts; max rms supply voltage per plate = 117 volts; max peak current per plate = 54 ma										12AL5
Class A Amplifier	180	180	8.5	29†	3.0†	58,000§	3,700	—	5,500	2.0	12AQ5
	250	250	12.5	45†	4.5†	52,000§	4,100	—	5,000	4.5	
Class A Amplifier	250	—	3.0	1.0	—	58,000	1,200	70	—	—	12AT6
	100	—	1.0	0.8	—	54,000	1,300	70	—	—	
Class A Amplifier ♣	250	—	$R_k = 200$	10	—	10,900	5,500	60	—	—	12AT7
	100	—	$R_k = 270$	3.7	—	15,000	4,000	60	—	—	
Class A Amplifier	250	150	$R_k = 68$	10.6	4.3	1,000,000§	5,200	—	—	—	12AU6
	100	100	$R_k = 150$	5.0	2.1	500,000§	3,900	—	—	—	
Class A Amplifier	250	—	$R_k = 330$	12.2	—	—	4,800	36	—	—	
Class A Amplifier ♣	250	—	8.5	10.5	—	7,700§	2,200	17	—	—	12AU7 12AU7-A
	100	—	0	11.8	—	6,500§	3,100	20	—	—	
Vertical Deflection Amplifier ♣	Max positive pulse plate voltage; □ = 1,200 volts; max d-c cathode current = 20 ma										

§ Approximate.

▲ Without external shield.

† Zero signal.

◆ Grids 3 and 5 are screen. Grid 4 is signal-input grid.

# Conversion transconductance.

♣ Maximum.

♥ Grids 2 and 4 are screen. Grid 3 is signal-input grid.

✱ Screen supply voltage.

⊖ Absolute maximum rating.

‡ Plate-to-plate.

♠ Per section.

◆ Design maximum rating.

⊕ For both sections.

\* Minimum.

¶ Heater warm-up time controlled for series-string service.

§ Plate supply voltage.

|| Input plate.

3—The duration of the pulse voltage must not exceed 15 percent of one scanning cycle.

1—Section 1.

2—Section 2.

4—A resistor of 3 ohms must be put in series with heater.

Tube Type	Classification by Construction	Base Connections	Out-line Dwg	Filament Volts	Filament Amp	Max Plate Watts	Max Plate Volts	Max Screen Volts	Capacitance in Micromicrofarads		
									Input	Out-put	Grid-plate
<b>12AV5-GA</b>	Beam Power Amplifier	6CK	T-X	12.6	0.6	11	550	175	14▲	7.0▲	0.5▲
<i>12AV6</i>	Duplex-Diode High-Mu Triode	7BT	5-2	12.6	0.15	0.5	300	—	2.2	1.2	2.0
<i>12AV7</i>	Twin Triode	9A	6-2	{ 6.3 12.6 }	{ 0.45 0.225 }	2.7♣	300	—	3.2	1.3 <sub>1</sub> 1.6 <sub>2</sub>	1.9
<i>12AV6</i>	Sharp-Cutoff RF Pentode	7CM	5-2	12.6	0.15	2.0 2.5	300 300	150 —	Pentode Connection Triode Connection (G <sub>2</sub> & P tied)		
<b>12AX4-GT</b> <b>12AX4-GTA</b>	Half-Wave High-Vacuum Rectifier	4CG	9-11 or 9-41	12.6	0.6	4.8	Tube Voltage Drop: 32 v at 250 ma d-c				
<i>12AX7</i>	High-Mu Twin Triode	9A	6-2	{ 12.6 6.3 }	{ 0.15 0.3 }	1.0♣	300	—	1.8	1.9	1.7
<i>12AY7</i>	Twin Triode	9A	6-2	{ 6.3 12.6 }	{ 0.3 0.15 }	1.5♣	300	—	1.3▲	0.6▲	1.3▲
<i>12AZ7</i>	Twin Triode	9A	6-2	{ 12.6 6.3 }	{ 0.225 0.45 }	2.5♣	330	—	3.2	1.3 <sub>1</sub> 1.6 <sub>2</sub>	1.9
<i>12B4</i> <i>12B4-A</i>	Low-Mu Triode	9AG	6-3	{ 12.6 6.3 }	{ 0.3 0.6 }	5.5	550	—	5.0▲	1.5▲	4.8▲
<b>12B8-GT</b>	Remote-Cutoff Pentode Triode	8T	9-24	12.6	0.3	—	90	90	Pentode Section Triode Section		
<i>12BA6</i>	Remote-Cutoff RF Pentode	7BK	5-2	12.6	0.15	3.0	300	150	5.5	5.0	0.0035♣
<i>12BA7</i>	Pentagrid Converter	8CT ▼	6-3	12.6	0.15	2.0	300	100	Osc I <sub>g1</sub> = 0.35 ma R <sub>g1</sub> = 20,000 ohms		
<i>12BD6</i>	Remote-Cutoff RF Pentode	7BK	5-2	12.6	0.15	3.0	300	125	4.3▲	5.0▲	0.005♣▲
<i>12BE6</i>	Pentagrid Converter	7CH ▼	5-2	12.6	0.15	1.0	300	100	Osc I <sub>g1</sub> = 0.5 ma R <sub>g1</sub> = 20,000 ohms		
<i>12BF6</i>	Duplex-Diode Medium-Mu Triode	7BT	5-2	12.6	0.15	2.5	300	—	1.8▲	1.1▲	2.0▲

Metal tubes are shown in bold-face type, miniature tubes in italics. ©Subminiature type.

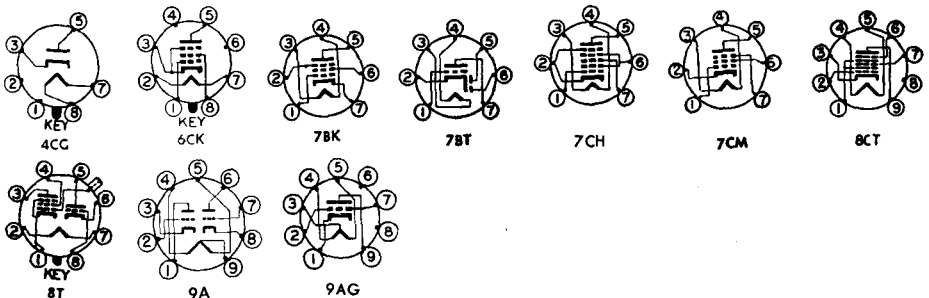



Service	Plate Volts	Screen Volts	Neg Grid Volts	Plate Milli-am-peres	Screen Milli-am-peres	R <sub>p</sub> ' Ohms	G <sub>m</sub> ' μmhos	μ Factor	Load for Rated Output, Ohms	Power Output, Watts	Tube Type
Horizontal Deflection Amplifier	250 60	150 150	22.5 0	57 260	2.1 26	14,500§	5,900	—	—	—	12AV5-GA¶
Max positive pulse plate voltage; □ = 5,500 volts; max screen dissipation = 2.5 watts; max d-c cathode current = 110 ma											
Class A Amplifier	250 100	— —	2.0 1.0	1.2 0.5	—	62,500 80,000	1,600 1,250	100 100	— —	— —	12AV6
Class A Amplifier †	150 100	— —	R <sub>k</sub> = 56 R <sub>k</sub> = 120	18 9.0	—	4,800 6,100	8,500 6,100	41 37	— —	— —	12AV7
Class A Amplifier	250	150	R <sub>k</sub> = 200	7.0	2.0	800,000§	5,000	—	—	—	12AW6
Class A Amplifier	250	—	R <sub>k</sub> = 825	5.5	—	11,000	3,800	42	—	—	
TV Damp-er Services	Max d-c output current = 125 ma; max peak inverse voltage □ = 4400 volts; max peak current = 750 ma										12AX4-GT 12AX4-GTA¶
Class A Amplifier †	100 250	— —	1.0 2.0	0.5 1.2	—	80,000 62,500	1,250 1,600	100 100	— —	— —	12AX7
Class A Amplifier †	250	—	4.0	3.0	—	25,000§	1,750	44	—	—	12AY7
Class A Amplifier	250 100	— —	R <sub>k</sub> = 200 R <sub>k</sub> = 270	10 3.7	—	10,900 15,000	5,500 4,000	60 60	— —	— —	12AZ7
Vertical Deflection Amplifier	150	—	17.5	34	—	1,030§	6,300	6.5	—	—	12B4 12B4-A¶
Max positive pulse plate voltage; □ = 1000 volts; max d-c cathode current = 30 ma											
Class A Amplifier	90	90	3.0	7.0	2.0	200,000	1,800	—	—	—	12B8-GT
Class A Amplifier	90	—	0	2.8	—	37,000	2,400	90	—	—	
Class A Amplifier	250 100	100 100	R <sub>k</sub> = 68 R <sub>k</sub> = 68	11 10.8	4.2 4.4	1,000,000§ 250,000§	4,400 4,300	— —	— —	— —	12BA6
Converter	250	100	1.0	3.8	10	1,000,000§	950 #	—	—	—	12BA7
Class A Amplifier	250	100	3.0	9.0	3.5	700,000	2,000	—	—	—	12BD6
Converter	250 100	100 100	1.5 1.5	2.9 2.6	6.8 7.0	1,000,000§ 400,000§	475 # 455 #	— —	— —	— —	12BE6
Class A Amplifier	250	—	9.0	9.5	—	8,500	1,900	16	—	—	12BF6

§ Approximate.  
 ▲ Without external shield.  
 † Zero signal.  
 ‡ Grids 3 and 5 are screen. Grid 4 is signal-input grid.  
 # Conversion transconductance.  
 \* Maximum.  
 ♣ Grids 2 and 4 are screen. Grid 3 is signal-input grid.  
 ✕ Screen supply voltage.  
 ⊖ Absolute maximum rating.  
 † Plate-to-plate.  
 ‡ Per section.  
 ◆ Design maximum rating.

⊕ For both sections.  
 \* Minimum.  
 ¶ Heater warm-up time controlled for series-string service.  
 § Plate supply voltage.  
 ‡ Input plate.  
 †—The duration of the pulse voltage must not exceed 15 percent of one scanning cycle.  
 1—Section 1.  
 2—Section 2.  
 †—A resistor of 3 ohms must be put in series with heater.

Tube Type	Classification by Construction	Base Connections	Out-line Dwg	Filament Volts	Filament Amp	Max Plate Watts	Max Plate Volts	Max Screen Volts	Capacitance in Micromicrofarads		
									Input	Output	Grid-plate
<i>12BH7</i>	Medium-Mu Twin Triode	9A	6-3	{ 12.6 6.3 }	{ 0.3 0.6 }	3.5 ♣	300 450	—	3.2 ▲ 0.42 <sub>2</sub> ▲	0.5 <sub>1</sub> ▲ 2.6 ▲	
<i>12BH7-A</i> ♣	Medium-mu Twin Triode	9A	6-3	{ 12.6 6.3 }	{ 0.3 0.6 }	3.5 ♣ 6.0 ⊕	300 500	— —	3.3 ▲	0.8 <sub>1</sub> ▲	2.4 ▲
<i>12BK5</i> ♣	Beam Power Amplifier	9BQ	6-3	12.6	0.6	9.0	250	250	13 ▲	5.0 ▲	0.6 ▲
<i>12BK6</i>	Duplex-Diode High-Mu Triode	7BT	5-3	12.6	0.15	—	300	—	—	—	—
<i>12BL6</i>	RF Pentode	7BK	5-2	12.6	0.15	—	30	30	5.2	5.4	0.005 ♣
<i>12BN6</i>	Gated-Beam Discriminator	7DF	5-3	12.6	0.15	—	300 ⊕	100	E <sub>c1</sub> = 1.25 volts rms*		
<i>12BQ6-GTA</i> ♣		6AM	9-49 or 9-50	12.6	0.6	11	600 ⊕	175	—	—	—
<i>12BQ6-GA</i> ♣ <i>12BQ6-GTB</i> ♣	Beam Power Amplifier	6AM	T-X 9-49 or 9-50	12.6	0.6	11	600 ⊕	200	15 ▲	7.0 ▲	0.6 ▲
<i>12BR7</i>	Duplex-Diode Triode	9CF	6-2	{ 12.6 6.3 }	{ 0.225 0.45 }	2.5	300	—	2.8	1.0	1.9
									Diode Sections		
<i>12BT6</i>	Duplex-Diode High-Mu Triode	7BT	5-3	12.6	0.15	—	300	—	—	—	—
<i>12BU6</i>	Duplex-Diode Medium-Mu Triode	7BT	5-3	12.6	0.15	—	300	—	—	—	—
<i>12BV7</i>	Sharp-Cutoff Pentode	9BF	6-3	{ 12.6 6.3 }	{ 0.3 0.6 }	6.25	300	175	11 ▲	3.0 ▲	0.055 ▲
<i>12BW4</i>	Full-Wave High-Vacuum Rectifier	9DJ	6-3	12.6	0.45	—	Tube Voltage Drop: ♣ 40 v at 100 ma d-c				
<i>12BY7</i> <i>12BY7-A</i> ♣	Sharp-Cutoff Pentode	9BF	6-3	{ 12.6 6.3 }	{ 0.3 0.6 }	6.5	300	180	10.2 ▲	3.5 ▲	0.063 ▲ ♣
<i>12BZ7</i>	High-Mu Twin Triode	9A	6-3	{ 12.6 6.3 }	{ 0.3 0.6 }	1.5 ♣	300	—	6.5 ▲	0.7 <sub>1</sub> ▲ 0.55 <sub>2</sub> ▲	2.5 ▲
<i>12C5</i> ♣	Beam Power Amplifier	7CV	5-3	12.6	0.6	5.5	135	117	13 ▲	9.0 ▲	0.55 ▲

Metal tubes are shown in bold-face type, miniature tubes in italics.

♣Subminiature type.

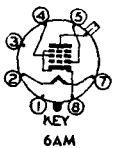

6AM



7BK

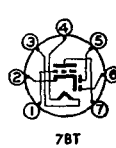

7BT



7CV

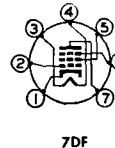

7DF

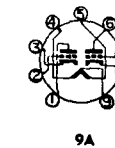

9A

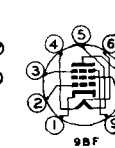

9BF



9BQ

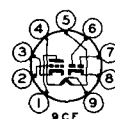

9CF



9DJ

Service	Plate Volts	Screen Volts	Neg Grid Volts	Plate Milli-amperes	Screen Milli-amperes	R <sub>p</sub> ' Ohms	G <sub>m</sub> ' μmhos	μ Factor	Load for Rated Output, Ohms	Power Output, Watts	Tube Type
Class A Amplifier ♣	250	—	10.5	11.5	—	5,300§	3,100	16.5	—	—	12BH7
Vertical Deflection Amplifier ♣	Max positive pulse plate voltages: □ = 1500 volts; max d-c cathode current = 20 ma										
Class A Amplifier ♣	250	—	10.5	11.5	—	5,500§	3,100	17	—	—	12BH7-A ¶
Vertical Deflection Amplifier	Max positive pulse plate voltages = 1,350 volts; max d-c cathode current = 20 ma										
Class A Amplifier	250	250	5.0	35†	3.5†	100,000§	8,500	—	6,500	3.5	12BK5 ¶
Class A Amplifier	250	100	—	2.0	1.2	62,500	1,600	100	—	—	12BK6
	100	—	1.0	0.5	—	80,000	1,250	100	—	—	
Class A Amplifier	12.6	12.6	E <sub>cc1</sub> = 0	1.35	0.5	500,000§	1,350	R <sub>g1</sub> = 2.2 meg	—	—	12BL6
FM Limiter-Discriminator	285‡	100	R <sub>k</sub> = 200 to 400	0.49	9.8	—	—	—	330000	—	12BN6
Horizontal Deflection Amplifier	250	150	22.5	55	2.1	20,000§	5,500	—	—	—	12BQ6-GTA ¶
	60	150	0	225	25	—	—	—	—	—	
	Max positive pulse plate voltages: □ = 6000 volts; max screen dissipation = 2.5 watts; max d-c cathode current = 110 ma										
Horizontal Deflection Amplifier	250	150	22.5	57	2.1	14,500	5,900	—	—	—	12BQ6-GA ¶
	60	150	0	260	26	—	—	—	—	—	12BQ6-GTB ¶
	Max positive pulse plate voltages: □ = 6,000 volts; max screen dissipation = 2.5 watts; max d-c cathode current = 110 ma										
Class A Amplifier	250	—	R <sub>k</sub> = 200	10	—	10,900	5,500	60	—	—	12BR7
	100	—	R <sub>k</sub> = 270	3.7	—	15,000	4,000	60	—	—	
Horizontal Phase Detector	Max peak output current ♣ = 60 ma; voltage drop ♣: 5 volts at 17 ma d-c										
Class A Amplifier	250	—	3.0	1.0	—	58,000	1,200	70	—	—	12BT6
	100	—	1.0	0.8	—	54,000	1,300	70	—	—	
Class A Amplifier	250	—	9.0	9.5	—	8,500	1,900	16	10,000	0.30	12BU6
Class A Amplifier	250	150	R <sub>k</sub> = 68	27	6.0	85,000§	13,000	—	—	—	12BV7
Full-Wave Rectifier	Max d-c output current = 100 ma; max peak inverse voltage = 1,275 volts; rms supply voltage per plate = 325 volts; max peak current per plate = 350 ma										
Class A Amplifier	250	180	R <sub>k</sub> = 100	26	5.75	93,000§	11,000	—	—	—	12BY7 12BY7-A ¶
Class A Amplifier ♣	250	—	2	2.5	—	31,800	3,200	100	—	—	12BZ7
Class A Amplifier	110	110	7.5	49†	4.0†	10,000§	7,500	—	2,500	1.9	12C5 ¶

§ Approximate.

▲ Without external shield.

† Zero signal.

‡ Grids 3 and 5 are screen. Grid 4 is signal-input grid.

# Conversion transconductance.

♣ Maximum.

♥ Grids 2 and 4 are screen. Grid 3 is signal-input grid.

✱ Screen supply voltage.

□ Absolute maximum rating.

† Plate-to-plate.

♣ Per section.

◆ Design maximum rating.

⊕ For both sections.

\* Minimum.

¶ Heater warm-up time controlled for series-string service.

‡ Plate supply voltage.

|| Input plate.

— The duration of the pulse voltage must not exceed 15 percent of one scanning cycle.

1—Section 1.

2—Section 2.

4—A resistor of 3 ohms must be put in series with heater.

Tube Type	Classification by Construction	Base Connections	Out-line Dwg	Fila-ment Volts	Fila-ment Amp	Max Plate Watts	Max Plate Volts	Max Screen Volts	Capacitance in Micromicrofarads		
									Input	Out-put	Grid-plate
<b>12C8</b>	Duplex-Diode Semi-Remote-Cutoff Pentode	8E	8-4	12.6	0.15	2.25	300	125	6.0	9.0	0.005 $\clubsuit$
<b>12CA5</b> ¶	Beam Power Amplifier	7CV	5-3	12.6	0.6	5.0	130	130	15▲	9▲	0.5▲
<b>12CM6</b>	Beam Power Amplifier	9CK	6-3	12.6	0.225	12 9.0 8.0	315 315 315	285 — 285	Pentode Connection Triode (Gr & P tied) or Pentode Connection		
<b>12CN5</b>	RF Pentode	7CV	5-3	12.6	0.45	—	16	16	—	—	—
<b>12CR6</b>	Diode Remote-Cutoff Pentode	7EA	5-2	12.6	0.15	2.5	300	150	—	—	—
<b>12CS5</b> ¶	Beam Power Amplifier	6CS5	6-3	12.6	0.6	10	300	150	15▲	9.0▲	0.5▲
<b>12CS6</b>	Dual-Control Heptode	7CH	5-2	12.6	0.15	1.0	300	100	—	—	—
<b>12CT8</b> ¶	Triode-Pentode	9DA	6-2	12.6	0.3	2.75 $\blacklozenge$ 2.5 $\blacklozenge$	300 $\blacklozenge$ 300 $\blacklozenge$	150 $\blacklozenge$ —	Pentode Section Triode Section		
<b>12CU5</b> ¶	Beam Power Amplifier	7CV	5-3	12.6	0.6	6.0	135	117	13.2▲	8.6▲	0.7▲
<b>12CU6</b>	Beam Power Amplifier	6AM	T-X	12.6	0.6	11	600 $\blacklozenge$	200	15▲	7.0▲	0.6▲
<b>12D4</b> ¶	Half-Wave High-Vacuum Rectifier	4CG	9-11 or 9-41	12.6	0.6	5.5 $\blacklozenge$	—	—	—	—	—
<b>12DQ6</b> ¶	Beam Power Amplifier	6AM	T-X	12.6	0.6	15	550 $\blacklozenge$	175	15▲	7.0▲	0.55▲
<b>12DQ6-A</b> ¶	Beam Power Amplifier	6AM	T-X	12.6	0.6	15	700 $\blacklozenge$	200	15▲	7.0▲	0.55▲
<b>12E5-GT</b>	Medium-Mu Triode	6Q	9-11	12.6	0.15	1.25	250	—	3.4	5.5	2.6
<b>12F5-GT</b>	High-Mu Triode	5M	9-17	12.6	0.15	—	300	—	1.9	3.4	2.4
<b>12F8</b>	Duplex-Diode-Pentode	9FH	6-2	12.6	0.15	—	30	30	4.5▲	3.0▲	0.06▲
									Diode Sections		

Metal tubes are shown in bold-face type, miniature tubes in italics.

¶Subminiature type.

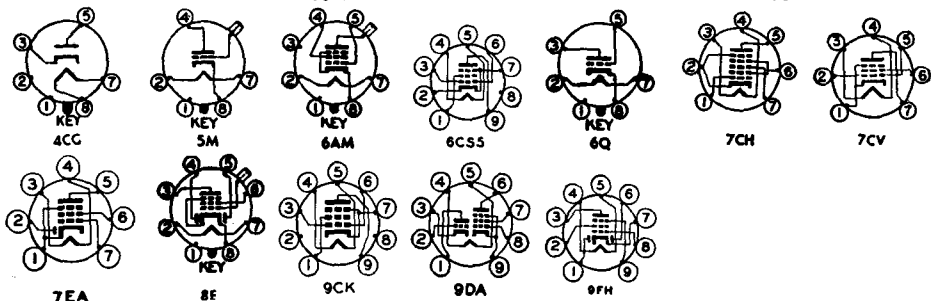

Service	Plate Volts	Screen Volts	Neg Grid Volts	Plate Milli-amperes	Screen Milli-amperes	R <sub>p</sub> , Ohms	G <sub>m</sub> , $\mu$ mhos	$\mu$ Factor	Load for Rated Output, Ohms	Power Output, Watts	Tube Type
Class A Amplifier	250	125	3.0	10	2.3	600,000 $\S$	1,325	—	—	—	12C8
Class A Amplifier	125 110	125 110	4.5 4.0	37 $\dagger$ 32 $\dagger$	4.0 $\dagger$ 3.5 $\dagger$	15,000 $\S$ 16,000 $\S$	9,200 8,100	—	4,500 3,500	1.5 1.1	12CA5 $\parallel$
Class A Amplifier Vertical Deflection Amplifier	250	250	12.5	45 $\dagger$	4.5 $\dagger$	50,000 $\S$	4,100	—	5,000	4.5	12CM6
Max positive pulse plate voltage $\boxtimes$ = 2000 volts; max screen dissipation (pentode connection only) = 1.75 watts; max d-c cathode current = 40 ma											
Class A Amplifier	12.6	12.6	E <sub>cc1</sub> = 0	4.5	0.35	40,000 $\S$	3,800	R <sub>g1</sub> = 2.2 meg	—	—	12CN5
Class A Amplifier	250	100	2.0	9.6	2.6	800,000 $\S$	2,200	—	—	—	12CR6
Class A Amplifier	200	125	R <sub>k</sub> = 180 75	46 $\dagger$ 49 $\dagger$	2.2 $\dagger$ 4.0 $\dagger$	28,000 $\S$ 13,000 $\S$	8,000 8,000	—	4,000 2,000	3.8 2.1	12CS5 $\parallel$
Gated Amplifier	100 100 10	30 30 30	1.0 0 0	1.0 0.8 2.0	1.3 5.5 4.5	1,000,000 $\S$ 700,000 $\S$ —	1,100 — —	E <sub>s</sub> = 0 volts E <sub>s2</sub> = -1.0 volts E <sub>s3</sub> = 0 volts	—	—	12CS6
Class A Amplifier Class A Amplifier	200 150	125 —	R <sub>k</sub> = 82 R <sub>k</sub> = 150	15 9.0	3.4 —	150,000 $\S$ 8,200 $\S$	7,000 4,900	— 40	— —	— —	12CT8 $\parallel$
Class A Amplifier	120	110	8.0	49 $\dagger$	4.0 $\dagger$	10,000 $\S$	7,500	—	2,500	2.3	12CU5 $\parallel$
Horizontal Deflection Amplifier	250 60	150 150	22.5 0	57 260	2.1 26	14,500 $\S$ —	5,900 —	— —	— —	— —	12CU6
Max positive pulse plate voltage $\boxtimes$ = 6000 volts; max screen dissipation = 2.5 watts; max d-c cathode current = 110 ma											
TV Dampers Service	Max d-c output current $\blacklozenge$ = 155 ma; max peak inverse voltage $\blacklozenge$ = 4,400 volts; max peak current $\blacklozenge$ = 900 ma										12D4 $\parallel$
Horizontal Deflection Amplifier	250 60	150 150	22.5 0	75 300	2.4 27	20,000 $\S$ —	6,000 —	— —	— —	— —	12DQ6 $\parallel$
Max positive pulse plate voltage $\boxtimes$ = 6,000 volts; max screen dissipation = 2.5 watts; max d-c cathode current = 120 ma											
Horizontal Deflection Amplifier	250 60	150 150	22.5 0	75 300	2.4 27	20,000 $\S$ —	6,600 —	— —	— —	— —	12DQ6-A $\parallel$
Max positive pulse plate voltage $\boxtimes$ = 6,000 volts; max screen dissipation = 3.0 watts; max d-c cathode current = 140 ma											
Class A Amplifier	250	—	13	5.0	—	9,500	1,450	13.8	—	—	12E5-GT
Class A Amplifier	250	—	2.0	0.9	—	66,000	1,500	100	—	—	12F5-GT
Class A Amplifier AM Detector	12.6	12.6	0	1.0	0.38	330,000 $\S$	1,000	—	—	—	12F8
Max d-c output current $\blacklozenge$ = 1.0 ma; voltage drop $\blacklozenge$ : 10 volts at 2.0 ma d-c											

$\S$  Approximate.

$\blacktriangle$  Without external shield.

$\dagger$  Zero signal.

$\blacklozenge$  Grids 3 and 5 are screen. Grid 4 is signal-input grid.

$\#$  Conversion transconductance.

$\blacklozenge$  Maximum.

$\blacktriangledown$  Grids 2 and 4 are screen. Grid 3 is signal-input grid.

$\blacklozenge$  Screen supply voltage.

$\boxtimes$  Absolute maximum rating.

$\dagger$  Plate-to-plate.

$\blacklozenge$  Per section.

$\blacklozenge$  Design maximum rating.

$\oplus$  For both sections.

\* Minimum.

$\parallel$  Heater warm-up time controlled for series-string service.

$\S$  Plate supply voltage.

$\parallel$  Input plate.

$\blacklozenge$  The duration of the pulse voltage must not exceed 15 percent of one scanning cycle.

1—Section 1.

2—Section 2.

4—A resistor of 3 ohms must be put in series with heater.

Tube Type	Classification by Construction	Base Connections	Out-line Dwg	Filament Volts	Filament Amp	Max Plate Watts	Max Plate Volts	Max Screen Volts	Capacitance in Micromicrofarads		
									Input	Out-put	Grid-plate
<i>12G4</i>	Medium-Mu Triode	6BG	5-3	12.6	0.15	2.5	300	—	2.6	3.2	3.4
<i>12G8</i>	Dissimilar Double Triode	9CZ	6-3	12.6	0.4	—	16 16	— —	Section 1 (Pins 6, 7, 8) Section 2 (Pins 1, 2, 3)		
<i>12H4</i>	Medium-Mu Triode	7DW	5-3	12.6 6.3	0.15 0.3	2.5	300	—	2.6	3.2	3.4
<b>12H6</b>	Twin Diode	7Q	8-5	12.6	0.15	—	Tube Voltage Drop: ♦ 11 v at 16 ma d-c				
<b>12J5</b> <i>12J5-GT</i>	Medium-Mu Triode	6Q	8-1 9-11 or 9-41	12.6	0.15	2.5	300	—	3.4 4.2	3.6 5.0	3.4 3.8
<i>12J7-GT</i>	Sharp-Cutoff Pentode	7R	9-18	12.6	0.15	0.75 1.75	300 250	125 —	Pentode Connected Triode Connected (G <sub>2</sub> , G <sub>3</sub> & P Tied)		
<i>12J8</i>	Duplex-Diode Tetrode	9GC	6-2	12.6	0.35	—	30	30	8.0▲	3.3▲	0.55▲
<i>12K5</i>	Space-Charge-Grid Tetrode	7EK	5-3	12.6	0.4	—	30	—	—	—	—
<i>12K7-GT</i>	Remote-Cutoff RF Pentode	7R	9-18	12.6	0.15	2.75	300	150	4.6	12.0	0.005 ♣
<b>12K8</b> <i>12K8-GT</i>	Triode Hexode Converter	8K♥	8-2 9-24	12.6	0.15	0.75 ♣	300	150	Osc I <sub>g1</sub> = 0.15 ma R <sub>g1</sub> = 50,000 ohms		
<i>12L6-GT</i> ¶	Beam Power Amplifier	7AC	9-11 or 9-41	12.6	0.6	10	200	125	15▲	10▲	0.8▲
<i>12L8-GT</i>	Twin-Pentode Power Amplifier	8BU	9-11	12.6	0.15	2.5♣	180	180	5.0▲	6.0▲	0.7▲
<i>12Q7-GT</i>	Duplex-Diode High-Mu Triode	7V	9-18	12.6	0.15	—	300	—	2.2	5.0	1.6
<i>12R6</i> ¶	Beam Power Amplifier	7CV	5-3	12.6	0.6	4.5	150	150	13▲	9.0▲	0.55▲
<i>12S7</i>	Diode Remote-Cutoff Pentode	8GX	T-X	12.6	0.1	2.0	250	125	4.5▲	5.1▲	0.002 ♣▲
<i>12S8-GT</i>	Triple-Diode High-Mu Triode	8CB	9-23	12.6	0.15	0.5	300	—	1.2	5.0	2.0
<b>12SA7</b> <i>12SA7-GT</i>	Pentagrid Converter	8R♥ 8AD♥	8-1 9-11 or 9-41	12.6	0.15	1.0	300	100	Osc I <sub>g1</sub> = 0.5 ma R <sub>g1</sub> = 20,000 ohms		

Metal tubes are shown in bold-face type, *miniature tubes in italics.*      ©Subminiature type.

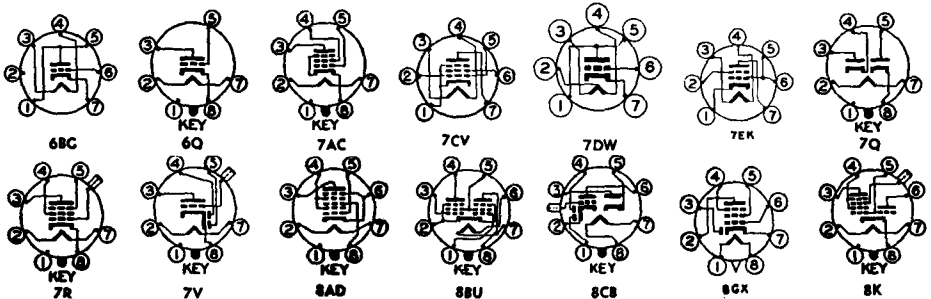

Service	Plate Volts	Screen Volts	Neg Grid Volts	Plate Milli-am-peres	Screen Milli-am-peres	R <sub>p</sub> , Ohms	G <sub>m</sub> , μmhos	μ Factor	Load for Rated Out-put, Ohms	Power Out-put, Watts	Tube Type
Class A Amplifier	90 250	—	0 8.0	10 9.0	—	6,700§ 7,700§	3,000 2,600	20 20	—	—	12G4
Direct-Coupled Amplifier	12.6, 12.6 <sub>2</sub>	—	0 <sub>1</sub>	3.0,† 7.2†	—	8,500§	2,600	22	—	2,000	0.025
Characteristics given are with pin 7 connected directly to pin 3. R <sub>p</sub> , G <sub>m</sub> , and μ are measured with respect to the grid voltage of input section (section 1) and the plate current and plate voltage of output section (section 2).											
Class A Amplifier	90 250	—	0 8.0	10 9.0	—	6,700§ 7,700§	3,000 2,600	20 20	—	—	12H4
Half-Wave Rectifier	Max d-c output current per plate = 8 ma; max peak inverse voltage = 420 volts; max rms supply voltage per plate = 150 volts; max peak current per plate = 48 ma										12H6
Class A Amplifier	90 250	—	0 8.0	10 9.0	—	6,700 7,700	3,000 2,600	20 20	—	—	12J5 12J5-GT
Class A Amplifier Class A Amplifier	250 250	100 —	3.0 8.0	2.0 6.5	0.5 —	1,000,000* 10,500	1,225 1,900	— 20	—	—	12J7-GT
Class A Amplifier AM De-tector	12.6	12.6	E <sub>ce1</sub> = 0	14	3.0	4,000§	5,400	R <sub>g1</sub> = 2.2 meg			12J8
Max d-c output current ♣ = 5.0 ma; voltage drop <sub>1</sub> : 5.0 volts at 8.5 ma d-c; voltage drop <sub>2</sub> : 5.0 volts at 12 ma d-c											
Class A Amplifier	12.6	—	2.5	8.0	—	600	9,000	—	800	0.040	12K5
E <sub>ce1</sub> = 12.6 volts; I <sub>ce1</sub> = 85 ma (Note: grid 1 is space-charge grid, grid 2 is control grid)											
Class A Amplifier	250	125	3.0	10.5	2.6	600,000§	1,650	—	—	—	12K7-GT
Converter	250	100	3.0	2.5	6.0	600,000§	350 #	E <sub>b</sub> (Triode Osc) = 100 I <sub>b</sub> (Triode) = 3.8 ma			12K8 12K8-GT
Class A Amplifier	200 110	125 110	R <sub>k</sub> = 180 7.5	46† 49†	2.2† 4.0†	28,000§ 13,000§	8,000 8,000	—	4,000 2,000	3.8 2.1	12L6-GT¶
Class A Amplifier ♣	180	180	9.0	13†	2.8†	160,000	2,150	—	10,000	1.0	12L8-GT
Class A Amplifier	250	—	3.0	1.0	—	58,000	1,200	70	—	—	12Q7-GT
Vertical Deflection Amplifier	110 45	110 110	8.5 0	40 120	3.3 17	13,000 —	7,000 —	—	—	—	12R5¶
Max positive pulse plate voltage ⊠ = 1,500 volts; max screen dissipation = 1.0 watts; max d-c cathode current = 45 ma											
Class A Amplifier	200	85	2.0	5.0	1.5	1,000,000§	2,000	—	—	—	12S7
Class A Amplifier	250	—	2.0	0.9	—	91,000	1,100	100	—	—	12S8-GT
Converter	250 100	100 100	2.0 2.0	3.5 3.3	8.5 8.5	1,000,000§ 500,000§	450 # 425 #	—	—	—	12SA7 12SA7-GT

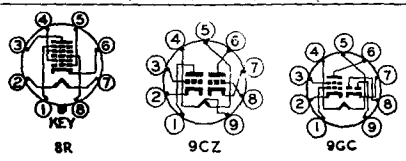

§ Approximate.  
 ▲ Without external shield.  
 † Zero signal.  
 ◆ Grids 3 and 5 are screen. Grid 4 is signal-input grid.  
 # Conversion transconductance.  
 ♣ Maximum.

♥ Grids 2 and 4 are screen. Grid 3 is signal-input grid.  
 \* Screen supply voltage.  
 ⊠ Absolute maximum rating.  
 † Plate-to-plate.  
 ♣ Per section.  
 ◆ Design maximum rating.  
 ⊕ For both sections.  
 \* Minimum.  
 ¶ Heater warm-up time controlled for series-warm service.  
 § Plate supply voltage.  
 # Input plate.  
 ‡—The duration of the pulse voltage must not exceed 15 percent of one scanning cycle.  
 1—Section 1.  
 2—Section 2.  
 †—A resistor of 3 ohms must be put in series with heater.

Tube Type	Classification by Construction	Base Connections	Outline Dwg	Filament Volts	Filament Amp	Max Plate Watts	Max Plate Volts	Max Screen Volts	Capacitance in Micromicrofarads		
									Input	Output	Grid-plate
<b>12SC7</b>	High-Mu Twin Triode	8S	8-1	12.6	0.15	—	250	—	—	—	—
<b>12SF5</b> <i>12SF5-GT</i>	High-Mu Triode	6AB	8-1 9-11	12.6	0.15	—	300	—	4.0	3.6	2.4
<b>12SF7</b> <i>12SF7-GT</i>	Diode Remote-Cutoff Pentode	7AZ	8-1 9-18	12.6	0.15	3.5	300	150	5.5 5.5	6.0 6.0	0.004♣ 0.004♣
<b>12SG7</b>	Semi-Remote-Cutoff RF Pentode	8BK	8-1	12.6	0.15	3.0	300	150	8.5	7.0	0.003♣
<b>12SH7</b>	Sharp-Cutoff RF Pentode	8BK	8-1	12.6	0.15	3.0	300	150	8.5	7.0	0.003♣
<b>12SJ7</b> <i>12SJ7-GT</i>	Sharp-Cutoff Pentode	8N	8-1 9-12	12.6	0.15	2.5	300	150	Pentode Connection		
						2.5	250	—	Triode Connection (G <sub>2</sub> , G <sub>3</sub> & P tied)		
<b>12SK7</b> <i>12SK7-GT</i>	Remote-Cutoff RF Pentode	8N	8-1 9-12	12.6	0.15	4.0	300	150	6.0 6.5	7.0 7.5	0.003♣ 0.005♣
<i>12SL7-GT</i>	High-Mu Twin Triode	8BD	9-11	12.6	0.15	1.0♣	300	—	—	—	—
<i>12SN7-GT</i>	Medium-Mu Twin Triode	8BD	9-11 or 9-41	12.6	0.3	3.5♣	300	—	2.8 <sub>1</sub> ▲ 3.0 <sub>2</sub> ▲	0.8 <sub>1</sub> ▲ 1.2 <sub>2</sub> ▲	3.8 <sub>1</sub> ▲ 4.0 <sub>2</sub> ▲
<i>12SN7-GTA</i>	Medium-Mu Twin Triode	8BD	9-11 or 9-41	12.6	0.3	5.0⊕ 5.0⊕ 7.5⊕	450	—	2.2 <sub>1</sub> ▲ 2.6 <sub>2</sub> ▲	0.7▲	4.0 <sub>1</sub> ▲ 3.8 <sub>2</sub> ▲
<b>12SQ7</b> <i>12SQ7-GT</i>	Duplex-Diode High-Mu Triode	8Q	8-1 9-12	12.6	0.15	0.5	300	—	3.2 4.2▲	3.0 3.4▲	1.6 1.8▲
<b>12SR7</b> <i>12SR7-GT</i>	Duplex-Diode Medium-Mu Triode	8Q	8-1 9-11	12.6	0.15	2.5	250	—	3.6 3.5	2.8 3.8	2.4 2.3
<b>12SW7</b>	Duplex-Diode Medium-Mu Triode	8Q	8-1	12.6	0.15	2.5	250	—	3.0	2.8	2.4
<i>12SX7-GT</i>	Medium-Mu Twin Triode	8BD	9-11	12.6	0.3	2.5♣	300	—	3.0 <sub>1</sub> 2.8 <sub>2</sub>	0.8 <sub>1</sub> 1.2 <sub>2</sub>	3.6
<b>12SY7</b> <i>12SY7-GT</i>	Pentagrid Converter	8R♥ 8AD♥	8-1 9-12	12.6	0.15	—	300	100	Osc I <sub>g1</sub> =0.5 ma R <sub>g1</sub> =20,000 ohms Osc I <sub>g1</sub> =0.1 ma R <sub>g1</sub> =20,000 ohms		
<i>12U7</i>	Twin Triode	9A	6-2	12.6	0.15	—	30	—	1.8	2.0	1.5
<i>12V6-GT</i>	Beam Power Amplifier	7AC	9-11 or 9-41	12.6	0.225	12	315	285	Single Tube		
									2 Tubes, Push-Pull		

Metal tubes are shown in bold-face type, miniature tubes in italics.

♣Subminiature type.

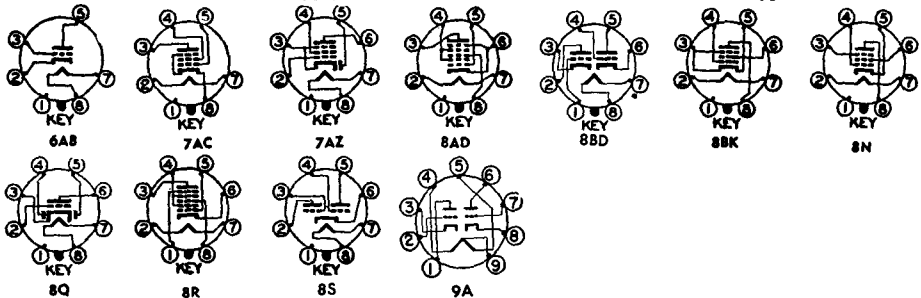



Service	Plate Volts	Screen Volts	Neg Grid Volts	Plate Milli-amperes	Screen Milli-amperes	R <sub>p</sub> , Ohms	G <sub>m</sub> , $\mu$ mhos	$\mu$ Factor	Load for Rated Output, Ohms	Power Output, Watts	Tube Type
Class A Amplifier ♣	250	—	2.0	2.0	—	53,000§	1,325	70	—	—	12SC7
Class A Amplifier	250	—	2.0	0.9	—	66,000	1,500	100	—	—	12SF5 12SF5-GT
Class A Amplifier	250 100	100 100	1.0 1.0	12.4 12	3.3 3.4	700,000§ 200,000§	2,050 1,975	—	—	—	12SF7 12SF7-GT
Class A Amplifier	250 250 100	150 125 100	2.5 1.0 1.0	9.2 11.8 8.2	3.4 4.4 3.2	1,000,000* 900,000 250,000	4,000 4,700 4,100	—	—	—	12SG7
Class A Amplifier	250	150	1.0	10.8	4.1	900,000§	4,900	—	—	—	12SH7
Class A Amplifier	250	100	3.0	3.0	0.8	1,000,000*	1,650	—	—	—	12SJ7
Class A Amplifier	250	—	8.5	9.2	—	7,600§	2,500	19	—	—	12SJ7-GT
Class A Amplifier	250 100	100 100	3.0 1.0	9.2 13	2.6 4.0	800,000§ 120,000§	2,000 2,350	—	—	—	12SK7 12SK7-GT
Class A Amplifier ♣	250	—	2.0	2.3	—	44,000	1,600	70	—	—	12SL7-GT
Class A Amplifier ♣	250 90	— —	8.0 0	9.0 10	—	7,700 6,700	2,600 3,000	20 20	—	—	12SN7-GT
Class A Amplifier ♣	250 90	— —	8.0 0	9.0 10	—	7,700§ 6,700§	2,600 3,000	20 20	—	—	12SN7-GTA
Vertical Deflection Amplifier ♣	Max positive pulse plate voltages ⊠ = 1,500 volts; max d-c cathode current = 20 ma										
Class A Amplifier	250 100	— —	2.0 1.0	1.1 0.5	—	85,000§ 110,000§	1,175 925	100 100	—	—	12SQ7 12SQ7-GT
Class A Amplifier	250	—	9.0	9.5†	—	8,500	1,900	16	10,000	0.3	12SR7 12SR7-GT
Class A Amplifier	250 26.5	—	9.0 R <sub>g</sub> = 2 meg	9.5 1.1	—	8,500 15,500	1,900 1,100	16 17	—	—	12SW7
Class A Amplifier ♣	250 26.5	—	8.0 R <sub>g</sub> = 05 mcg	9.0 1.8	—	7,700 11,500	2,600 1,800	20 21	—	—	12SX7-GT
Converter Converter	250 28	100 28	2.0 1.0	3.5 0.5	8.5 1.8	1,000,000§ —	450 # 250 #	—	—	—	12SY7 12SY7-GT
Class A Amplifier ♣	12.6	—	0	1.0	—	12,500§	1,600	20	—	—	12U7
Class A Amplifier	315 250 180	225 250 180	13 12.5 8.5	34† 45† 29†	2.2† 4.5† 3.0†	80,000§ 50,000§ 50,000§	3,750 4,100 3,700	— — —	8,500 5,000 5,500	5.5 4.5 2.0	12V6-GT
Class AB <sub>1</sub> Amplifier	285 250	285 250	19 70	70† 5.0†	4.0† 5.0†	70,000§ 60,000§	3,600 3,750	— —	8,000† 10,000†	14 10	

§ Approximate.

▲ Without external shield.

† Zero signal.

♣ Grids 3 and 5 are screen. Grid 4 is signal-input grid.

# Conversion transconductance.

♣ Maximum.

♥ Grids 2 and 4 are screen. Grid 3 is signal-input grid.

\* Screen supply voltage.

⊠ Absolute maximum rating.

† Plate-to-plate.

♣ Per section.

♣ Design maximum rating.

⊕ For both sections.

\* Minimum.

† Heater warm-up time controlled for series-string service.

‡ Plate supply voltage.

|| Input plate.

§—The duration of the pulse voltage must not exceed 15 percent of one scanning cycle.

1—Section 1.

2—Section 2.

‡—A resistor of 3 ohms must be put in series with heater.

Tube Type	Classification by Construction	Base Connections	Out-line Dwg	Fila-ment Volts	Fila-ment Amp	Max Plate Watts	Max Plate Volts	Max Screen Volts	Capacitance in Micromicrofarads		
									Input	Out-put	Grid-plate
12W6-GT	Beam Power Amplifier	7AC	9-11 or 9-41	12.6	0.6	10 7.5	300 300	150 —	Pentode Connection Triode Connection (G <sub>2</sub> & P tied)		
<i>12X4</i>	Full-Wave High-Vacuum Rectifier	5BS	5-3	12.6	0.3	—	Tube Voltage Drop: ♦ 22 v at 70 ma d-c				
12Z3	Half-Wave High-Vacuum Rectifier	4G	12-5	12.6	0.3	—	Tube Voltage Drop: 17 v at 110 ma d-c				
14A4	Medium-Mu Triode	5AC	9-30	12.6	0.15	2.5	300	—	3.4	3.0	4.0
14A5	Beam Power Amplifier	6AA	9-30	12.6	0.15	7.5	250	250	—	—	—
14A7/12B7	Remote-Cutoff Pentode	8V	9-30	12.6	0.15	4.0	300	125	6.0	7.0	0.005 ♣
14AF7	Medium-Mu Twin Triode	8AC	9-30	12.6	0.15	2.5 ♣	300	—	2.2	1.6	2.3
14B6	Duplex-Diode High-Mu Triode	8W	9-30	12.6	0.15	0.5	300	—	—	—	—
14B8	Pentagrid Converter	8X♦	9-30	12.6	0.15	1.0	300	100	Osc I <sub>g1</sub> = 0.4 ma R <sub>g1</sub> = 50,000 ohms		
14C5	Beam Power Amplifier	6AA	9-31	12.6	0.225	12	315	285	—	—	—
14C7	Sharp-Cutoff Pentode	8V	9-30	12.6	0.15	1.0	300	100	6.0	6.5	0.007 ♣
14E6	Duplex-Diode High-Mu Triode	8W	9-30	12.6	0.15	2.5	250	—	—	—	—
14E7	Duplex-Diode Remote-Cutoff Pentode	8AE	9-30	12.6	0.15	2.0	250	100	4.6	5.3	0.005 ♣
14F7	High-Mu Twin Triode	8AC	9-30	12.6	0.15	1.0 ♣	250	—	—	—	—
14F8	High-Frequency Twin Triode	8BW	9-32	12.6	0.15	3.5 ♣ 3.5 ⊕	300	—	2.8	1.4	1.6
14H7	Semi-Remote-Cutoff RF Pentode	8V	9-30	12.6	0.15	2.5	300	150	8.0	7.0	0.004 ♣
14J7	Triode-Heptode Converter	8BL	9-30	12.6	0.15	0.5 1.25	300 150	100 —	Osc I <sub>g1</sub> = 0.4 ma R <sub>g1</sub> = 50,000 ohms Triode Section		
<i>14K7</i>	Triode-Hexode Converter	8GY	T-X	14.0	0.1	1.5 0.8	250 175	125 —	Hexode Section Triode Section		
<i>14L7</i>	Duplex-Diode-Triode	8GZ	T-X	14.0	0.1	1.0	250	—	—	—	—

Metal tubes are shown in bold-face type, miniature tubes in italics.

♣Subminiature type.

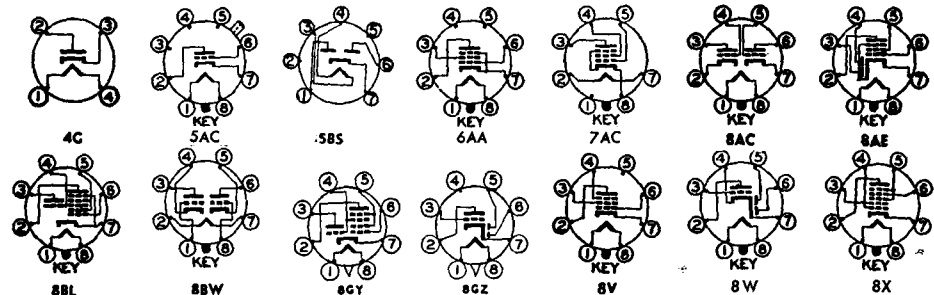

Service	Plate Volts	Screen Volts	Neg Grid Volts	Plate Milli-amperes	Screen Milli-amperes	$R_p$ , Ohms	$G_m$ , $\mu$ mhos	$\mu$ Factor	Load for Rated Out-put, Ohms	Power Out-put, Watts	Tube Type
Class A Amplifier	200	125	$R_k = 180$	46†	2.2†	28,000§	8,000	—	4,000	3.8	12W6-GT¶
	110	110	7.5	49†	4.0†	13,000§	8,000	—	2,000	2.1	
Vertical Deflection Amplifier	225	—	30	22	—	1,600§	3,800	6.2	—	—	
Max positive pulse plate voltage; □ = 1,200 volts; max d-c cathode current = 60 ma											
Full-Wave Rectifier	Max d-c output current = 70 ma; max peak inverse voltage = 1,250 volts; rms supply voltage per plate = 325 volts; max peak current per plate = 210 ma										12X4
Half-Wave Rectifier	Max d-c output current = 55 ma; max peak inverse voltage = 700 volts; max rms supply voltage = 235 volts; max peak current = 330 ma										12Z3
Class A Amplifier	250	—	8.0	9.0	—	7,700§	2,600	20	—	—	14A4
	90	—	0	10	—	6,700§	3,000	20	—	—	
Class A Amplifier	250	250	12.5	30†	3.5†	70,000§	3,000	—	7,500	2.8	14A5
Class A Amplifier	250	100	3.0	9.2	2.6	800,000§	2,000	—	—	—	14A7/12B7
Class A Amplifier ♦	250	—	10	9.0	—	7,600	2,100	16	—	—	14AF7
Class A Amplifier	250	—	2.0	0.9	—	91,000§	1,100	100	—	—	14B6
	100	—	1.0	0.4	—	110,000§	900	100	—	—	
Converter	250	100	3.0	3.5	2.7	360,000§	550 #	E <sub>c2</sub> (Osc Plate) = 250 thru 20,000 ohms I <sub>c2</sub> = 4.0 ma			14B8
Class A Amplifier	315	225	13	34†	2.2†	77,000§	3,750	—	8,500	5.5	14C5
Class A Amplifier	250	100	3.0	2.2	0.7	1,000,000§	1,575	—	—	—	14C7
Class A Amplifier	250	—	9.0	9.5	—	8,500	1,900	16	—	—	14E6
Class A Amplifier	250	100	3.0	7.5	1.6	700,000§	1,300	—	—	—	14E7
Class A Amplifier ♦	250	—	2.0	2.3	—	44,000§	1,600	70	—	—	14F7
Class A Amplifier ♦	250	—	R <sub>k</sub> = 500	6.0	—	—	3,300	48	—	—	14F8
Class A Amplifier	250	150	$R_k = 180$	10	3.2	800,000§	4,000	—	—	—	14H7
	100	100	1.5	7.5	2.6	350,000§	4,000	—	—	—	
Converter	250	100	3.0	1.4	2.8	1,500,000§	290 #	E <sub>b</sub> (Triode Osc) = 250 thru 20,000 ohms I <sub>b</sub> (Triode) = 5.0 ma			14J7
Converter	200	85	2.0	3.0	3.0	1,000,000*	750 #	—	—	—	14K7
	100	—	0	10	—	—	2,800	22	—	—	
Class A Amplifier	170	—	1.6	1.5	—	42,000§	1,650	70	—	—	14L7

§ Approximate.

▲ Without external shield.

† Zero signal.

♦ Grids 3 and 5 are screen. Grid 4 is signal-

input grid.

# Conversion transconductance.

◆ Maximum.

▼ Grids 2 and 4 are screen. Grid 3 is signal-

input grid.

✱ Screen supply voltage.

□ Absolute maximum rating.

† Plate-to-plate.

◆ Per section.

◆ Design maximum rating.

⊗ For both sections.

\* Minimum.

¶ Heater warm-up time controlled for series-string service.

§ Plate supply voltage.

|| Input plate.

— The duration of the pulse voltage must not exceed 15 percent of one scanning cycle.

1—Section 1.

2—Section 2.

1—A resistor of 3 ohms must be put in series with heater.

Tube Type	Classification by Construction	Base Connections	Out-line Dwg	Filament Volts	Filament Amp	Max Plate Watts	Max Plate Volts	Max Screen Volts	Capacitance in Micromicrofarads		
									Input	Output	Grid-plate
14N7	Medium-Mu Twin Triode	8AC	9-31	12.6	0.3	2.5 $\uparrow$	300	—	—	—	—
14Q7	Pentagrid Converter	8AL $\heartsuit$	9-30	12.6	0.15	1.0	300	100	Osc $I_{g1} = 0.5$ ma $R_{g1} = 20,000$ ohms		
14R7	Duplex-Diode Remote-Cutoff Pentode	8AE	9-30	12.6	0.15	2.0	250	125	5.6	5.3	0.004 $\uparrow$
14S7	Triode-Heptode Converter	8BL	9-30	12.6	0.15	0.6	300	100	Osc $I_{g1} = 0.4$ ma $R_{g1} = 50,000$ ohms Triode Section		
14W7	Sharp-Cutoff RF Pentode	8BJ	9-30	12.6	0.225	—	300	150	—	—	—
14X7	Duplex-Diode High-Mu Triode	8BZ	9-31	12.6	0.15	—	300	—	—	—	—
14Y4	Full-Wave High-Vacuum Rectifier	5AB	9-30	12.6	0.3	—	Tube Voltage Drop: $\uparrow$ 22 v at 70 ma d-c				
15	Sharp-Cutoff RF Pentode	5F	12-6	2.0 DC	0.22	—	135	67.5	2.35 $\blacktriangle$	7.80 $\blacktriangle$	0.01
15A6	Sharp-Cutoff Pentode	9AR	6-4	15.0	0.3	9.0	250	250	—	—	—
15A8 $\nabla$	Triode-Pentode	8GS	9-49	15.0	0.6	10 2.5 7.5	300 300	150	Pentode Section — Triode Section Pentode Section-Triode Connection G and P tied		
16A5	Power Amplifier Pentode	9BL	6-4	16.5	0.3	9.0	250	250	11 $\blacktriangle$	5.9 $\blacktriangle$	1.0 $\clubsuit$ $\blacktriangle$
17AV5-GA $\nabla$	Beam Power Amplifier	6CK	T-X	16.8	0.45	11	550 $\clubsuit$	175	14 $\blacktriangle$	7.0 $\blacktriangle$	0.5 $\blacktriangle$
17AX4-GT $\nabla$	Half-Wave High-Vacuum Rectifier	4CG	9-11 or 9-41	16.8	0.45	4.8	Tube Voltage Drop: 32 v at 250 ma d-c				
17C5 $\nabla$	Beam Power Amplifier	7CV	5-3	16.8	0.45	5.5	135	117	13 $\blacktriangle$	9.0 $\blacktriangle$	0.55 $\blacktriangle$
17DQ6 $\nabla$	Beam Power Amplifier	6AM	T-X	16.8	0.45	15	550 $\clubsuit$	175	15 $\blacktriangle$	7.0 $\blacktriangle$	0.55 $\blacktriangle$
17H3 $\nabla$	Half-Wave High-Vacuum Rectifier	9FK	6-3	17.5	0.3	3.0 $\blacklozenge$	Tube Voltage Drop: 22 v at 140 ma d-c				
17Z3	Half-Wave High-Vacuum Rectifier	9CB	T-X	17	0.3	—	—	—	—	—	—
18A5 $\nabla$	Beam Power Amplifier	6CK	9-15 or 9-43	18.5	0.3	9.0 $\blacklozenge$	350 $\blacklozenge$	160 $\blacklozenge$	13 $\blacktriangle$	7.0 $\blacktriangle$	0.7 $\blacktriangle$

Metal tubes are shown in bold-face type, miniature tubes in italics.

◊Subminiature type.

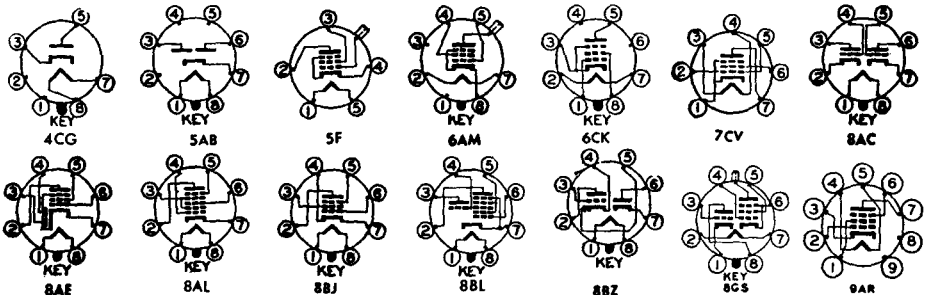

Service	Plate Volts	Screen Volts	Neg Grid Volts	Plate Milli-am-peres	Screen Milli-am-peres	R <sub>p</sub> ' Ohms	G <sub>m</sub> ' μmhos	μ Factor	Load for Rated Out-put, Ohms	Power Out-put, Watts	Tube Type
Class A Amplifier †	250	—	8.0	9.0	—	7,700	2,600	20	—	—	14N7
Converter	250	100	2.0	3.5	8.5	1,000,000‡	550 #	—	—	—	14Q7
Class A Amplifier	250 100	100 100	1.0 1.0	5.7 5.5	2.1 2.2	1,000,000‡ 350,000‡	3,200 3,000	—	—	—	14R7
Converter	250	100	2.0	1.8	3.0	1,250,000‡	525 #	(E <sub>b</sub> Triode Osc) = 250 thru 20,000 ohms I <sub>b</sub> (Triode) = 5.0 ma		—	14S7
Class A Amplifier	300	150	R <sub>k</sub> = 160	10	3.9	300,000	5,800	—	—	—	14W7
Class A Amplifier	250	—	1.0	1.9	—	67,000	1,500	100	—	—	14X7
Full-Wave Rectifier	Max d-c output current = 70 ma; max peak inverse voltage = 1250 volts; max rms supply voltage per plate = 325 volts; max peak current per plate = 210 ma										14Y4
Class A Amplifier	135	67.5	1.5	1.85	0.3	800,000	750	—	—	—	15
Class A Amplifier	180	180	2.9	36	4.6	100,000	10,000	—	—	—	15A6
Class A Amplifier Vertical Deflection Amplifier	110	110	7.5	45	4.0	13,000‡	7,300	—	—	—	15A8¶
	250	—	8.0	9.0	—	7,700‡	2,600	20	—	—	
	225	—	30	25	—	1,600‡	3,800	6.0	—	—	
Max positive pulse voltage; □ = 1,200 volts; max d-c cathode current = 40 ma											
Class A Amplifier	170	170	10.4	53	10	20,000	9,000	—	3,000	4.0	16A5
Horizontal Deflection Amplifier	250 60	150 150	22.5 0	57 260	2.1 26	14,500‡	5,900	—	—	—	17AV5-GA¶
Max positive pulse plate voltage; □ = 5,500 volts; max screen dissipation = 2.5 watts; max d-c cathode current = 110 ma											
TV Damper Service	Max d-c output current = 125 ma; max peak inverse voltage □ = 4,400 volts; max peak current = 750 ma										17AX4-GT¶
Class A Amplifier	110	110	7.5	49†	4.0†	10,000‡	7,500	—	2,500	1.9	17C5¶
Horizontal Deflection Amplifier	250	150	22.5	75	2.4	20,000‡	6,000	—	—	—	17DQ6¶
	60	150	0	300	27	—	—	—	—	—	
Max positive pulse plate voltage; □ = 6,000 volts; max screen dissipation = 2.5 watts; max d-c cathode current = 120 ma											
TV Damper Service	Max d-c output current ♦ = 75 ma; max peak inverse voltage ♦ = 2,000 volts; max peak current ♦ = 450 ma										17H3¶
TV Damper Service	Max d-c output current = 150 ma; max peak inverse voltage = 4,500 volts; max peak current = 450 ma										17Z3
Horizontal Deflection Amplifier	200	125	17	40	1.1	27,000‡	4,800	—	—	—	18A5¶
	60	125	0	165	15	—	—	—	—	—	
Max positive pulse plate voltage; ♦ = 3,000 volts; max screen dissipation ♦ = 2.5 watts; max d-c cathode current ♦ = 90 ma											

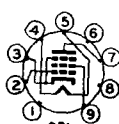

- ♣ Per section.
- ♠ Maximum.
- ‡ Approximate.
- # Conversion transconductance.
- ▼ Grids 2 and 4 are screen. Grid 3 is signal-input grid.
- ▲ Without external shield.
- The duration of the pulse voltage must not exceed 15 percent of one scanning cycle.
- † Zero signal.
- ‡ Plate supply voltage.
- Absolute maximum rating.
- ♦ Design maximum rating.
- ¶ Heater warm-up time controlled for series-string service.

Tube Type	Classification by Construction	Base Connections	Out-line Dwg	Fila-ment Volts	Fila-ment Amp	Max Plate Watts	Max Plate Volts	Max Screen Volts	Capacitance in Micromicrofarads		
									Input	Out-put	Grid-plate
19	Twin-Triode Power Amplifier	6C	12-5	2.0 DC	0.26	—	135	—	Both Sections in Push-pull		
19AQ5	Beam Power Amplifier	7BZ	5-3	18.9	0.15	12	250	250	—	—	—
19AU4†	Half-Wave High-Vacuum Rectifier	4CG	9-44	18.9	0.6	6.0	Tube Voltage Drop: 25 v at 350 ma d-c				
19AU4-GTA†	Half-Wave High-Vacuum Rectifier	4CG	9-44	18.9	0.6	6.0	Tube Voltage Drop: 25 v at 350 ma d-c				
19BG6-G 19BG6-GA	Beam Power Amplifier	5BT	16-5 T-X	18.9	0.3	20	700‡	350	12	6.5	0.34
19C8	Triple-Diode, High-Mu Triode	9E	6-2	18.9	0.15	1.0	250	—	—	—	—
19J6	Medium-Mu Twin Triode	7BF	5-2	18.9	0.15	1.5♣	300	—	2.0▲	0.4▲	1.5▲
19T8	Triple-Diode High-Mu Triode	9E	6-2	18.9	0.15	1.0	300	—	1.6▲	1.0▲	2.2▲
19V8	Triple-Diode, High-Mu Triode	9AH	6-2	18.9	0.15	1.0	300	—	—	—	—
19X3	Half-Wave High-Vacuum Rectifier	9BM	6-4	19	0.3	—	Tube Voltage Drop: 16 volts at 180 ma d-c				
19X8	Triode-Pentode Converter	9AK	6-2	18.9	0.15	2.0	250	250	Pentode Section		
						1.5	250	—	Triode Section		
19Y3	Half-Wave High-Vacuum Rectifier	9BM	6-4	19	0.3	—	Tube Voltage Drop: 15 volts at 180 ma d-c				
20	Power Amplifier Triode	4D	9-25	3.3 DC	0.132	—	135	—	2.0	2.3	4.1
21A6	Beam Power Amplifier	9AS	T-X	21.5	0.3	8.0	250	250	—	—	—
21B6	Beam Power Amplifier	9AS	T-X	21.5	0.3	8.0	250	250	—	—	—
22	Sharp-Cutoff RF Tetrode	4K	14-2	3.3 DC	0.132	—	135	67.5	3.5	10.0	0.02♣
24A	Sharp-Cutoff RF Tetrode	5E	14-2	2.5	1.75	—	250	90	5.3▲	10.5▲	0.007♣
25A6 25A6-GT	Power Amplifier Pentode	7S	8-6 9-11	25.0	0.3	5.3	160	135	8.5	12.5	0.2

Metal tubes are shown in bold-face type, miniature tubes in italics.      †Subminiature type.

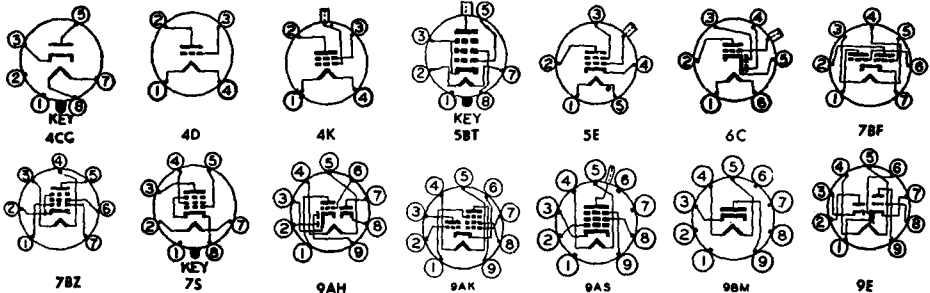

Service	Plate Volts	Screen Volts	Neg Grid Volts	Plate Milli-am-peres	Screen Milli-am-peres	R <sub>p</sub> , Ohms	G <sub>m</sub> , μmhos	μ Fac-tor	Load for Rated Out-put, Ohms	Power Out-put, Watts	Tube Type
Class B Amplifier	135	—	0	5.0† ♣	—	Input Signal = 0.170 watt‡		—	10,000‡	2.1‡	19
Class A Amplifier	250 180	250 180	12.5 8.5	45† 29†	4.5† 3.0†	52,000‡ 58,000‡	4,100 3,700	—	5,000 5,500	4.5 2.0	19AQ5
TV Damp-er Service, TV Damp-er Service,	Max d-c output current = 175 ma; max peak inverse voltage = 4,500 volts; max peak current = 1,050 ma Max d-c output current = 190 ma; max peak inverse voltage = 4,500 volts; max peak current = 1,150 ma										19AU4¶ 19AU4-GTA¶
Horizontal Deflection Amplifier	250 60	250 250	15 0	75 180	4 18	25,000‡	6,000	—	—	—	19BG6-G 19BG6-GA
Max positive pulse plate voltage; = 6,600 volts; max screen dissipation = 3.2 watts; max d-c cathode current = 110 ma											
Class A Amplifier	100	—	1.0	0.5	—	80,000	1,250	100	—	—	19C8
Class A Amplifier ♣	100	—	R <sub>k</sub> = 150 ⊕	8.5	—	7,100	5,300	38	—	—	19J6
Class A Amplifier	250 100	—	3.0 1.0	1.0 0.8	—	58,000‡ 54,000‡	1,200 1,300	70 70	—	—	19T8
Class A Amplifier	250 100	—	3.0 1.0	1.0 0.8	—	58,000‡ 54,000‡	1,200 1,300	70 70	—	—	19V8
TV Damp-er Service,	Max d-c output current = 180 ma; max peak inverse voltage = 4,000 volts; max peak current = 400 ma										19X3
Class A Amplifier	250	150	R <sub>k</sub> = 200	7.7	1.6	750,000‡	4,600	—	—	—	19X8
Class A Amplifier	100	—	R <sub>k</sub> = 100	8.5	—	6,900‡	5,800	40	—	—	
Half-Wave Rectifier	Max d-c output current = 180 ma; max peak inverse voltage = 700 volts; max rms supply voltage = 250 volts										19Y3
Class A Amplifier	135	—	22.5	6.5†	—	6,300	525	3.3	6,500	0.110	20
Horizontal Deflection Amplifier	180 180	180 180	23 0	45 430	3.0 29	—	6,500	—	—	—	21A6
Max positive pulse plate voltage = 7,000 volts; max screen dissipation = 4.5 watts; max d-c cathode current = 150 ma											
Horizontal Deflection Amplifier	180 180	180 180	23 0	45 430	3.0 29	—	6,500	—	—	—	21B6
Max positive pulse plate voltage = 7,000 volts; max screen dissipation = 4.5 watts; max d-c cathode current = 150 ma											
Class A Amplifier	135	67.5	1.5	3.7	1.3	325,000	500	—	—	—	22
Class A Amplifier	250	90	3.0	4.0	1.7 ♣	600,000	1,050	—	—	—	24A
Class A Amplifier	160	120	18	33†	6.5†	42,000	2,375	—	5,000	2.2	25A6 25A6-GT

‡ Approximate.

▲ Without external shield.

† Zero signal.

◆ Grids 3 and 5 are screen. Grid 4 is signal-input grid.

# Conversion transconductance.

♣ Maximum.

◆ Grids 2 and 4 are screen. Grid 3 is signal-input grid.

\* Screen supply voltage.

⊕ Absolute maximum rating.

† Plate-to-plate.

♣ Per section.

⊕ Design maximum rating.

¶ For both sections.

\* Minimum.

¶ Heater warm-up time controlled for series-string service.

‡ Plate supply voltage.

|| Input plate.

3—The duration of the pulse voltage must not exceed 15 percent of one scanning cycle.

1—Section 1.

2—Section 2.

4—A resistor of 3 ohms must be put in series with heater.

Tube Type	Classification by Construction	Base Connections	Outline Dwg	Filament Volts	Filament Amp	Max Plate Watts	Max Plate Volts	Max Screen Volts	Capacitance in Micromicrofarads		
									Input	Output	Grid-plate
25A7-GT	Half-Wave Rectifier Power Amplifier Pentode	8F	9-11	25.0	0.3	2.25	117	—	—	—	—
25AC5-GT	Triode Power Amplifier	6Q	9-11	25.0	0.3	10	180	—	2 tubes, Push-pull		
25AV5-GA	Beam Power Amplifier	6CK	T-X	25.0	0.3	11	550	175	14▲	7.0▲	0.5▲
25AV5-GT	Beam Power Amplifier	6CK	9-11 or 9-41	25.0	0.3	11	550	175	14▲	7.0▲	0.7▲
25AX4-GT	Half-Wave High-Vacuum Rectifier	4CG	9-11 or 9-41	25.0	0.3	4.8	Tube Voltage Drop: 32 v at 250 ma d-c				
25B5	Direct-Coupled Power Amplifier	6D	12-1	25.0	0.3	8.5 1.1	180	—	—	—	—
25B6-G	Power Amplifier Pentode	7S	14-3	25.0	0.3	12.5	200	135	—	—	—
25B8-GT	Triode Remote-Cutoff Pentode	8T	9-24	25.0	0.15	—	100	100	Pentode Section		
						—			Triode Section		
<i>25BK5</i>	Beam Power Amplifier	9BQ	6-3	25.0	0.3	9.0	250	250	13▲	5.0▲	0.6▲
25BQ6-GA 25BQ6-GTB	Beam Power Amplifier	6AM	T-X 9-49 or 9-50	25.0	0.3	11	600	200	15▲	7.0▲	0.6▲
25BQ6-GT	Beam Power Amplifier	6AM	9-49 or 9-50	25.0	0.3	11	550	175	15▲	7.5▲	0.6▲
<i>25C5</i>	Beam Power Amplifier	7CV	5-3	25.0	0.3	5.5	135	117	13▲	9.0▲	0.55▲
25C6-G 25C6-GA	Beam Power Amplifier	7AC	14-3 T-X	25.0	0.3	12.5	200	135	—	—	—
<i>25CA5</i>	Beam Power Amplifier	7CV	5-3	25.0	0.3	5.0	130	130	15▲	9.0▲	0.5▲
25CD6-G 25CD6-GA†	Beam Power Amplifier	5BT	16-5	25.0	0.6	15	700	175	25▲	9.5▲	0.6▲
25CD6-GB†	Beam Power Amplifier	5BT	T-X	25.0	0.6	20	700	175	22▲	8.5▲	1.1▲

Metal tubes are shown in bold-face type, miniature tubes in italics.

◎Subminiature type.

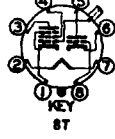
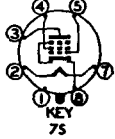
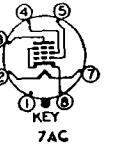
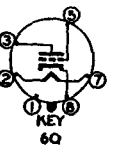
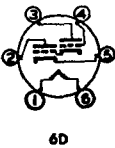
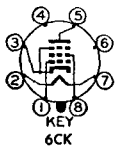
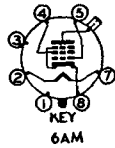
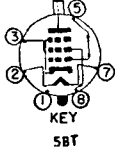
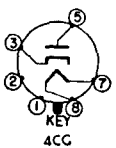



Service	Plate Volts	Screen Volts	Neg Grid Volts	Plate Milli-amperes	Screen Milli-amperes	R <sub>p</sub> , Ohms	G <sub>m</sub> , μmhos	μ Factor	Load for Rated Output, Ohms	Power Output, Watts	Tube Type
Class A Amplifier Half-Wave Rectifier	100	100	15	20.5†	4.0†	50,000	1,800	—	4,500	0.77	25A7-GT
Max d-c output current = 75 ma; max peak inverse voltage = 350 v; max rms supply voltage = 117 v; max peak current = 450 ma											
Class B Amplifier	180	—	0	4.0†	—	Peak Input Signal = 0.810 watt		—	4,800 ‡	6.0	25AC5-GT
Horizontal Deflection Amplifier	250 60	150 150	22.5 0	57 260	2.1 26	14,500§	5,900	—	—	—	25AV5-GA
Max positive pulse plate voltage ⊕ = 5,500 volts; max screen dissipation = 2.5 watts; max d-c cathode current = 110 ma											
Horizontal Deflection Amplifier	250 60	150 150	22.5 0	55 225	2.1 25	20,000§	5,500	—	—	—	25AV5-GT
Max positive pulse plate voltage ⊕ = 5,500 volts; max screen dissipation = 2.5 watts; max d-c cathode current = 110 ma											
TV Damp-er Services	Max d-c output current = 125 ma; max peak inverse voltage ⊕ = 4,400 volts max peak current = 750 ma										25AX4-GT
Class A Amplifier	180	100	0	46	5.8	15,000	2,300	—	4,000	3.8	25B5
Class A Amplifier	200	135	23	62†	1.8†	18,000	5,000	—	2,500	7.1	25B6-G
Class A Amplifier	100	100	3.0	7.6	2.0	185,000	2,000	—	—	—	25B8-GT
Class A Amplifier	100	—	1.0	0.6	—	75,000	1,500	112	—	—	
Class A Amplifier	250	250	5.0	35†	3.5†	100,000§	8,500	—	6,500	3.5	25BK5
Horizontal Deflection Amplifier	250 60	150 150	22.5 0	57 260	2.1 26	14,500§	5,900	—	—	—	25BQ6-GA 25BQ6-GTB
Max positive pulse plate voltage ⊕ = 6,000 volts; max screen dissipation = 2.5 watts; max d-c cathode current = 110 ma											
Horizontal Deflection Amplifier	250 60	150 150	22.5 0	55 225	2.1 25	20,000§	5,500	—	—	—	25BQ6-GT
Max positive pulse plate voltage ⊕ = 5,500 volts; max screen dissipation = 2.5 watts; max d-c cathode current = 110 ma											
Class A Amplifier	110	110	7.5	49†	4.0†	10,000§	7,500	—	2,500	1.9	25C5
Class A Amplifier	200	135	14	61†	2.2†	18,300†	7,100	—	2,600	6.0	25C6-G 25C6-GA
Class A Amplifier	125 110	125 110	4.5 4.0	37† 32†	4.0† 3.5†	15,000§ 16,000§	9,200 8,100	—	4,500 3,500	1.5 1.1	25CA5
Horizontal Deflection Amplifier	175 60	175 100	30 0	75 230	5.5 21	7,200§	7,700	—	—	—	25CD6-G 25CD6-GA¶
Max positive pulse plate voltage ⊕ = 6,600 volts; max screen dissipation = 3.0 watts; max d-c cathode current = 200 ma											
Horizontal Deflection Amplifier	175 60	175 100	30 0	75 230	5.5 21	7,200§	7,700	—	—	—	25CD6-GB¶
Max positive pulse plate voltage ⊕ = 7,000 volts; max screen dissipation = 3.0 watts; max d-c cathode current = 200 ma											

§ Approximate.

▲ Without external shield.

† Zero signal.

‡ Grids 3 and 5 are screen. Grid 4 is signal-

input grid.

# Conversion transconductance.

◆ Maximum.

♥ Grids 2 and 4 are screen. Grid 3 is signal-

input grid.

\* Screen supply voltage.

⊕ Absolute maximum rating.

† Plate-to-plate.

‡ Per section.

◆ Design maximum rating.

⊗ For both sections.

\* Minimum.

¶ Heater warm-up time controlled for series-string service.

§ Plate supply voltage.

|| Input plate.

— The duration of the pulse voltage must not exceed 15 percent of one scanning cycle.

— Section 1.

— Section 2.

— A resistor of 3 ohms must be put in series with heater.

Tube Type	Classification by Construction	Base Connections	Out-line Dwg	Filament Volts	Filament Amp	Max Plate Watts	Max Plate Volts	Max Screen Volts	Capacitance in Micromicrofarads		
									Input	Output	Grid-plate
25CU6	Beam Power Amplifier	6AM	T-X	25.0	0.3	11	600♣	200	15▲	7.0▲	0.6▲
25D8-GT	Diode-Triode-Pentode	8AF	9-23	25.0	0.15	—	100	100	Pentode Section Triode Section		
25DN6♣	Beam Power Amplifier	5BT	T-X	25.0	0.6	15	700♣	175	22▲	11.5▲	0.8▲
25DQ6	Beam Power Amplifier	6AM	T-X	25.0	0.3	15	550♣	175	15▲	7.0▲	0.55▲
25E5	Beam Power Amplifier	8GT	T-X	25.0	0.3	10	250	250	—	—	—
<i>25F5</i>	Beam Power Amplifier	7CV	5-3	25.0	0.15	4.5	135	117	—	—	—
<b>25L6</b>	Beam Power Amplifier	7AC	8-6	25.0	0.3	10	200	117	16.0	13.5	0.3
25L6-GT	Beam Power Amplifier	7AC	9-11 or 9-41	25.0	0.3	10	200	125	15▲	10▲	0.8▲
25N6-G	Direct-Coupled Power Amplifier	7W	12-3	25.0	0.3	8.5 1.1	180 180	—	—	—	—
25U4-GT	Half-Wave High-Vacuum Rectifier	4CG	9-13	25.0	0.3	—	Tube Voltage Drop: 21 v at 250 ma d-c				
25W4-GT	Half-Wave High-Vacuum Rectifier	4CG	9-11 or 9-41	25.0	0.3	3.5	Tube Voltage Drop: 21 v at 250 ma d-c				
25W6-GT	Beam Power Amplifier	7AC	9-11 or 9-41	25.0	0.3	10 7.5	300	150	Pentode Connection		
							300	—	Triode Connection (G <sub>2</sub> & P tied)		
25X6-GT	High-Vacuum Rectifier Doubler	7Q	9-11	25.0	0.15	—	Tube Voltage Drop: ♣ 25 v at 120 ma d-c				
25Y5	High-Vacuum Rectifier Doubler	6E	12-5	25.0	0.3	—	—	—	—	—	—
<b>25Z4</b>	Half-Wave High-Vacuum Rectifier	5AA	8-1	25.0	0.3	—	Tube Voltage Drop: 20.5 v at 250 ma d-c				
25Z5	High-Vacuum Rectifier Doubler	6E	12-5	25.0	0.3	—	Tube Voltage Drop: ♣ 22 v at 150 ma d-c				

Metal tubes are shown in bold-face type, miniature tubes in *italics*.

♣Subminiature type.

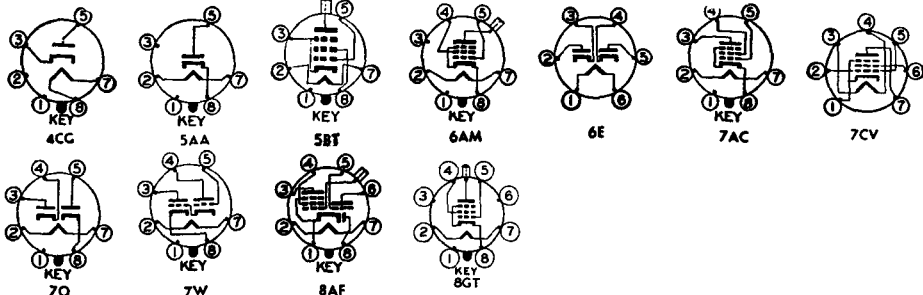

Service	Plate Volts	Screen Volts	Neg Grid Volts	Plate Milli-am-peres	Screen Milli-am-peres	R <sub>p</sub> , Ohms	G <sub>m</sub> , μmhos	μ Factor	Load for Rated Out-put, Ohms	Power Out-put, Watts	Tube Type
Horizontal Deflection Amplifier	250 60	150 150	22.5 0	57 260	2.1 26	14,500§	5,900	—	—	—	25CU6
	Max positive pulse plate voltage ⊞ = 6,000 volts; max screen dissipation = 2.5 watts; max d-c cathode current = 110 ma										
Class A Amplifier	100	100	3.0	8.5	2.7	200,000	1,900	—	—	—	25D8-GT
Class A Amplifier	100	—	1.0	0.5	—	91,000	1,100	—	—	—	
Horizontal Deflection Amplifier	125 50	125 100	18 0	70 240	6.3 30	4,000§	9,000	—	—	—	25DN6¶
	Max positive pulse plate voltage ⊞ = 6,600 volts; max screen dissipation = 3.0 watts; max d-c cathode current = 200 ma										
Horizontal Deflection Amplifier	250 60	150 150	22.5 0	75 300	2.4 27	20,000§	6,000	—	—	—	25DQ6
	Max positive pulse plate voltage ⊞ = 6,000 volts; max screen dissipation = 2.5 watts; max d-c cathode current = 120 ma										
Horizontal Deflection Amplifier	100	100	7.7	100	7.0	5,300	14,000	—	—	—	25E5
	Max positive pulse plate voltage ⊞ = 7,000 volts; max screen dissipation = 5.0 watts; max d-c cathode current = 200 ma										
Class A Amplifier	110	110	7.5	36†	3.0†	16,000§	5,800	—	2,500	1.2	25F6
Class A Amplifier	200 110	110 110	8.0 7.5	50† 49†	2.0† 4.0†	30,000§ 13,000§	9,500 9,000	—	3,000 2,000	4.3 2.1	25L6
Class A Amplifier	200	125	R <sub>k</sub> = 180 7.5	46†	2.2†	28,000§	8,000	—	4,000	3.8	25L6-GT
Class A Amplifier	110	110	0	49†	4.0†	13,000§	8,000	—	2,000	2.1	
Class A Amplifier	180	100	0	46	5.8	15,000	2,300	—	4,000	3.8	25N6-G
Half-Wave Rectifier TV Damp-er Service	Max d-c output current = 125 ma; max peak inverse voltage = 1250 volts; rms supply voltage = 350 volts; max peak current = 600 ma										25U4-GT
TV Damp-er Service	Max d-c output current = 125 ma; max peak inverse voltage ⊞ = 3850 volts; max peak current = 750 ma										25W4-GT
Class A Amplifier	200	125	R <sub>k</sub> = 180 7.5	46†	2.2†	28,000§	8,000	—	4,000	3.8	25W6-GT
Vertical Deflection Amplifier	110	110	0	49†	4.0†	13,000§	8,000	—	2,000	2.1	
	225	—	30	22	—	1,600§	3,800	6.2	—	—	
	Max positive pulse plate voltage ⊞ = 1200 volts; max d-c cathode current = 60 ma										
Rectifier or Doubler	Max d-c output current per plate = 60 ma; rms supply voltage per plate = 125 volts										25X6-GT
Rectifier or Doubler	Max d-c output current per plate = 42 ma; max peak inverse voltage = 700 volts; max rms supply voltage per plate = 250 volts										25Y5
Half-Wave Rectifier	Max d-c output current = 125 ma; max peak inverse voltage = 700 volts, max rms supply voltage = 235 volts; max peak current = 750 ma										25Z4
Rectifier or Doubler	Max d-c output current per plate = 75 ma; max peak inverse voltage = 700 volts; max rms supply voltage per plate = 235 volts; max peak current per plate = 450 ma										25Z5

§ Approximate.

▲ Without external shield.

† Zero signal.

♦ Grids 3 and 5 are screen. Grid 4 is signal-input grid.

# Conversion transconductance.

♣ Maximum.

♥ Grids 2 and 4 are screen. Grid 3 is signal-input grid.

✱ Screen supply voltage.

⊞ Absolute maximum rating.

‡ Plate-to-plate.

♠ Per section.

⊕ Design maximum rating.

⊙ For both sections.

\* Minimum.

¶ Heater warm-up time controlled for series-string service.

§ Plate supply voltage.

|| Input plate.

‡ The duration of the pulse voltage must not exceed 15 percent of one scanning cycle.

1—Section 1.

2—Section 2.

4—A resistor of 3 ohms must be put in series with heater.

Tube Type	Classification by Construction	Base Connections	Out-line Dwg	Filament Volts	Filament Amp	Max Plate Warts	Max Plate Volts	Max Screen Volts	Capacitance in Micromicrofarads		
									Input	Out-put	Grid-plate
<b>25Z6</b> <i>25Z6-GT</i>	High-Vacuum Rectifier Doubler	7Q	8-6 9-11	25.0	0.3	—	Tube Voltage Drop: $\blacklozenge$ 22 v at 150 ma d-c				
26	Medium-Mu Triode	4D	14-1	1.5	1.05	—	180	—	2.8	2.5	8.1
<i>26A6</i>	Remote-Cutoff RF Pentode	7BK	5-2	26.5	0.07	5.3	250	100	6.0	5.0	0.0035
26A7-GT	Twin-Pentode Power Amplifier	8BU	9-33 or 9-44	26.5	0.6	2.0 $\blacklozenge$	50	50	16.0 $\blacktriangle$	13.0 $\blacktriangle$	1.2 $\blacktriangle$
<i>26C6</i>	Duplex-Diode Medium-Mu Triode	7BT	5-2	26.5	0.07	2.5	250	—	1.8	1.4	2.0
<i>26CG6</i>	Remote-Cutoff Pentode	7BK	5-2	26.5	0.07	4.0	300	150	5.0	5.0	0.008 $\blacklozenge$
<i>26D6</i>	Pentagrid Converter	7CH $\heartsuit$	5-2	26.5	0.07	1.0	300	100	Osc $I_{g1} = 0.5$ ma $R_{g1} = 20,000$ ohms		
26E6-G	Beam Power Amplifier	7S	T-X	26.5	0.3	12.5	200	135	—	—	—
<i>26Z5</i>	Full-Wave High-Vacuum Rectifier	9BS	6-2	26.5	0.2	—	Tube Voltage Drop: $\blacklozenge$ 22 v at 100 ma d-c				
27	Medium-Mu Triode	5A	12-5	2.5	1.75	—	275	—	3.1	2.3	3.3
28D7	Double Beam Power Amplifier	8BS	9-31	28.0	0.4	3.0 $\blacklozenge$	100	67.5	—	—	—
28Z5	Full-Wave High-Vacuum Rectifier	5AB	9-31	28.0	0.24	—	Tube Voltage Drop: $\blacklozenge$ 40 v at 100 ma d-c				
30	Medium-Mu Triode	4D	12-5 or 9-26	2.0 DC	0.06	—	180	—	3.0 $\blacktriangle$	2.2 $\blacktriangle$	6.0 $\blacktriangle$
31	Power-Amplifier Triode	4D	12-5	2.0 DC	0.13	—	180	—	3.5	2.7	5.7
<i>31A3</i>	Half-Wave High-Vacuum Rectifier	8HB	6-3	31.0	0.1	—	—	—	—	—	—
32	Sharp-Cutoff RF Tetrode	4K	14-2	2.0 DC	0.06	—	180	67.5	5.3 $\blacktriangle$	10.5 $\blacktriangle$	0.015
32L7-GT	Half-Wave Rectifier Beam Power Amplifier	8Z	9-11	32.5	0.3	—	90	90	—	—	—
33	Power Amplifier Pentode	5K	14-1	2.0 DC	0.26	—	180	180	8.0	12.0	1.0

Metal tubes are shown in bold-face type, miniature tubes in *italics*.  $\circ$ Subminiature type.

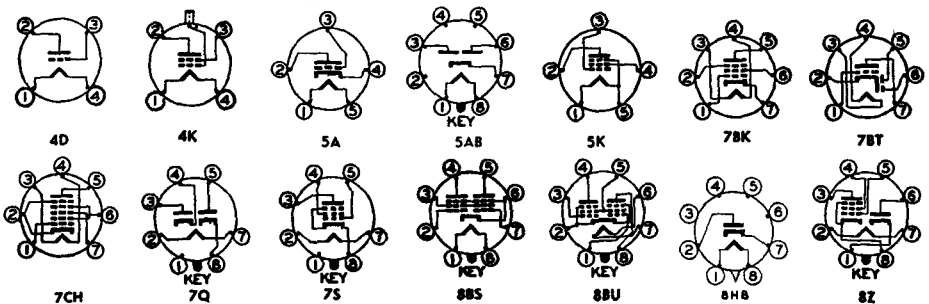

Service	Plate Volts	Screen Volts	Neg Grid Volts	Plate Milli-am-peres	Screen Milli-am-peres	R <sub>p</sub> Ohms	G <sub>m</sub> μmhos	μ Factor	Load for Rated Out-put, Ohms	Power Out-put, Watts	Tube Type
Rectifier or Doubler	Max d-c output current per plate = 75 ma; max peak inverse voltage = 700 volts; max rms supply voltage per plate = 235 volts; max peak current per plate = 450 ma										25Z6 25Z6-GT
Class A Amplifier	180	—	14.5	6.2	—	7,300	1,150	8.3	—	—	26
Class A Amplifier	250	100	R <sub>k</sub> = 125	10.5	4.0	1,000,000	4,000	—	—	—	28A6
	26.5	26.5	R <sub>g</sub> = 2 meg	1.7	0.7	250,000	2,000	—	—	—	
Class A Amplifier ♠	26.5	26.5	4.5	20†	1.9†	—	5,700	—	1,500	0.18	26A7-GT
Class A Amplifier	250	—	9.0	9.5	—	8,500	1,900	16	—	—	26C6
	26.5	—	R <sub>g</sub> = 2 meg	1.1	—	15,500	1,100	17	—	—	
Class A Amplifier	250	150	8.0	9.0	2.3	720,000	2,000	—	—	—	28CG6
Converter	250	100	1.5	3.0	7.8	1,000,000§	475 #	—	—	—	28D6
Class A Amplifier	200	135	14	61†	3.0†	18,000	7,100	—	2,600	6.0	26E6-G
Full-Wave Rectifier	Max d-c output current per plate = 50 ma; max peak inverse voltage = 1250 volts; rms supply voltage per plate = 325 v; max peak current per plate = 300 ma										26Z5
Class A Amplifier	250	—	21	5.2	—	9,250	975	9.0	—	—	27
Class A Amplifier ♠	28	28	3.5	12.5†	1.0†	4,200	3,400	—	4,000	0.100	28D7
Full-Wave Rectifier	Max d-c output current = 100 ma; max peak inverse voltage = 1250 volts; max rms supply voltage per plate = 325 volts; max peak current per plate = 300 ma										28Z5
Class A Amplifier	180	—	13.5	3.1	—	10,300§	900	9.3	—	—	30
Class A Amplifier	180	—	30	12.3†	—	3,600	1,050	3.8	5,700	0.375	31
Half-Wave Rectifier	Max d-c output current = 100 ma; max rms supply voltage = 250 volts										31A3
Class A Amplifier	180	67.5	3.0	1.7	0.4	1,200,000	650	—	—	—	32
Class A Amplifier	90	90	7.0	27†	2.0†	17,000	4,800	—	2,600	1.0	32L7-GT
	90	90	5.0	38†	3.0†	15,000	6,000	—	2,600	0.8	
Half-Wave Rectifier	Max d-c output current = 60 ma; max rms supply voltage = 125 v										
Class A Amplifier	180	180	18	22†	5.0†	55,000§	1,700	—	6,000	1.4	33

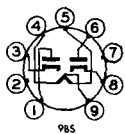

- § Approximate.
- ▲ Without external shield.
- † Zero signal.
- ‡ Grids 3 and 5 are screen. Grid 4 is signal-input grid.
- # Conversion transconductance.
- ♣ Maximum.
- ▼ Grids 2 and 4 are screen. Grid 3 is signal-input grid.
- \* Screen supply voltage.
- ⊖ Absolute maximum rating.
- ‡ Plate-to-plate.
- ♣ Per section.
- ◆ Design maximum rating.
- ⊕ For both sections.
- \* Minimum.
- ¶ Heater warm-up time controlled for series-string service.
- || Plate supply voltage.
- || Input plate.
- The duration of the pulse voltage must not exceed 15 percent of one scanning cycle.
- 1— Section 1.
- 2— Section 2.
- ← A resistor of 3 ohms must be put in series with heater.

Tube Type	Classification by Construction	Base Connections	Out-line Dwg	Filament Volts	Filament Amp	Max Plate Watts	Max Plate Volts	Max Screen Volts	Capacitance in Micromicrofarads		
									Input	Output	Grid-plate
<b>34</b>	Remote-Cutoff RF Pentode	<b>4M</b>	14-2	2.0 DC	0.06	—	180	67.5	6.0▲	11.0▲	0.015♣
<b>35/51</b>	Remote-Cutoff RF Tetrode	<b>5E</b>	14-2	2.5	1.75	—	275	90	5.3▲	10.5▲	0.007♣
<b>35A5</b>	Beam Power Amplifier	<b>6AA</b>	9-31	35.0	0.15	8.5	200	125	—	—	—
<b>35B6</b>	Beam Power Amplifier	<b>7BZ</b>	5-3	35.0	0.15	4.5	117	117	11▲	6.5▲	0.4▲
<b>35C6</b>	Beam Power Amplifier	<b>7CV</b>	5-3	35.0	0.15	4.5	117	117	12▲	9.0▲	0.6▲
<b>35CD6-GA†</b>	Beam Power Amplifier	<b>5BT</b>	T-X	35.0	0.45	20	700♣	175	22▲	8.5▲	1.1▲
<b>35L6-GT</b>	Beam Power Amplifier	<b>7AC</b>	9-11 or 9-41	35.0	0.15	8.5	200	125	—	—	—
<b>35W4</b>	Half-Wave High-Vacuum Rectifier	<b>5BQ</b>	5-3	35.0	0.15	—	Tube Voltage Drop: 18 v at 200 ma d-c				
<b>35Y4</b>	Half-Wave High-Vacuum Rectifier	<b>5AL</b>	9-31	35.0	0.15	—	Tube Voltage Drop: 18 v at 200 ma d-c				
<b>35Z3</b>	Half-Wave High-Vacuum Rectifier	<b>4Z</b>	9-31	35.0	0.15	—	Tube Voltage Drop: 18 v at 200 ma d-c				
<b>35Z4-GT</b>	Half-Wave High-Vacuum Rectifier	<b>5AA</b>	9-11	35.0	0.15	—	Tube Voltage Drop: 18 v at 200 ma d-c				
<b>35Z5-GT</b>	Half-Wave High-Vacuum Rectifier	<b>6AD</b>	9-11 or 9-41	35.0	0.15	—	Tube Voltage Drop: 18 v at 200 ma d-c				
<b>35Z6-G</b>	High-Vacuum Rectifier Doubler	<b>7Q</b>	14-3	35.0	0.3	—	Tube Voltage Drop: 20v at 220 ma d-c				
<b>36</b>	Sharp-Cutoff RF Tetrode	<b>5E</b>	12-6	6.3	0.3	0.8	250	90.0	3.8▲	9.0▲	0.007♣
<b>37</b>	Medium-Mu Triode	<b>5A</b>	12-5	6.3	0.3	—	250	—	3.5	2.9	2.0
<b>38</b>	Power Amplifier Pentode	<b>5F</b>	12-6	6.3	0.3	—	250	250	3.5	7.5	0.30

Metal tubes are shown in bold-face type, miniature tubes in italics.      ©Subminiature type.

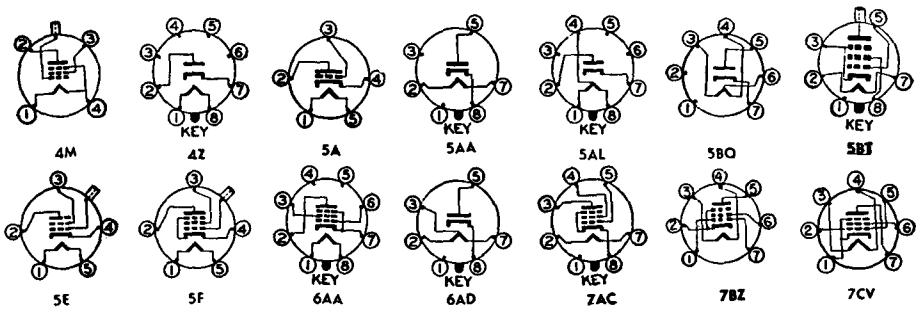

Service	Plate Volts	Screen Volts	Neg Grid Volts	Plate Milli-amperes	Screen Milli-amperes	$R_p$ , Ohms	$G_m$ , $\mu$ mhos	$\mu$ Factor	Load for Rated Output, Ohms	Power Output, Watts	Tube Type
Class A Amplifier	180	67.5	3.0	2.8	1.0	1,000,000	620	—	—	—	34
Class A Amplifier	250	90	3.0	6.5	2.5♣	400,000	1,050	—	—	—	35/51
Class A Amplifier	200	125	$R_k = 180$	43†	2.0†	34,000§	6,100	—	5,000	3.0	35A5
	110	110	7.5	40†	3.0†	14,000§	5,800	—	2,500	1.5	
Class A Amplifier	110	110	7.5	40†	3.0†	—	5,800	—	2,500	1.5	35B5
Class A Amplifier	110	110	7.5	40†	3.0†	—	5,800	—	2,500	1.5	35C5
Horizontal Deflection Amplifier	175	175	30	75	5.5	7,200§	7,700	—	—	—	35DC6-GA¶
	60	100	0	230	21	—	—	—	—	—	
Class A Amplifier	200	125	$R_k = 180$	43†	2.0†	34,000§	6,100	—	5,000	3.0	35L6-GT
	110	110	7.5	40†	3.0†	14,000§	5,800	—	2,500	1.5	
Half-Wave Rectifier	Max d-c output current = 100 ma; max peak inverse voltage = 330 volts; rms supply voltage = 117 volts; max peak current = 600 ma. With panel lamp #40 or #47 between pins 4 and 6 and no shunting resistor, max d-c output current = 60 ma. With panel lamp and 250 ohm shunting resistor (max), max d-c output = 90 ma										35W4
Half-Wave Rectifier	Max d-c output current = 100 ma; max peak inverse voltage = 700 volts; max rms supply voltage = 235 volts; max peak current = 600 ma. With panel lamp #40 or #47 between pins 1 and 4 and no shunting resistor, max d-c output current = 60 ma. With panel lamp and 250 ohm shunting resistor (max), max d-c output = 90 ma										35Y4
Half-Wave Rectifier	Max d-c output current = 100 ma; max peak inverse voltage = 700 volts; rms supply voltage = 235 volts, max peak current = 600 ma										35Z3
Half-Wave Rectifier	Max d-c output current = 100 ma; max peak inverse voltage = 700 volts; max rms supply voltage = 235 volts; max peak current = 600 ma										35Z4-GT
Half-Wave Rectifier	Max d-c output current = 100 ma; max peak inverse voltage = 700 volts; max rms supply voltage = 235 volts; max peak current = 600 ma. With panel lamp #40 or #47 between pins 2 and 3 and no shunting resistor, max d-c output current = 60 ma. With panel lamp and 250 ohm shunting resistor (max), max d-c output = 90 ma										35Z5-GT
Rectifier or Doubler	Max d-c output current per plate = 110 ma; max peak inverse voltage = 700 volts; max rms supply voltage per plate = 235 volts; max peak current per plate = 660 ma										35Z6-G
Class A Amplifier	250	90	3.0	3.2	1.7♣	550,000	1,080	—	—	—	36
Class A Amplifier	250	—	18	7.5	—	8,400	1,100	9.2	—	—	37
Class A Amplifier	250	250	25	22	3.8	100,000	1,200	—	10,000	2.5	38

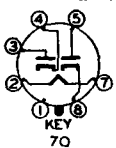

§ Approximate.

▲ Without external shield.

† Zero signal.

◆ Grids 3 and 5 are screen. Grid 4 is signal-input grid.

# Conversion transconductance.

♣ Maximum.

▼ Grids 2 and 4 are screen. Grid 3 is signal-input grid.

✖ Screen supply voltage.

☐ Absolute maximum rating.

‡ Plate-to-plate.

♣ Per section.

◆ Design maximum rating.

⊕ For both sections.

\* Minimum.

¶ Heater warm-up time controlled for series-string service.

§ Plate supply voltage.

|| Input plate.

— The duration of the pulse voltage must not exceed 15 percent of one scanning cycle.

1—Section 1.

2—Section 2.

4—A resistor of 3 ohms must be put in series with heater.

Tube Type	Classification by Construction	Base Connections	Out-line Dwg	Fila-ment Volts	Fila-ment Amp	Max Plate Watts	Max Plate Volts	Max Screen Volts	Capacitance in Micromicrofarads		
									Input	Out-put	Grid-plate
39/44	Remote-Cutoff RF Pentode	5F	12-6	6.3	0.3	1.5	250	90	3.8▲	10.0▲	0.007♣
40	Medium-Mu Triode	4D	14-1	5.0 DC	0.25	—	180	—	2.8	2.2	2.0
41	Power Amplifier Pentode	6B	12-5	6.3	0.4	8.5	315	285	—	—	—
42	Power Amplifier Pentode	6B	14-1	6.3	0.7	11	375	285	—	—	—
43	Power Amplifier Pentode	6B	14-1	25.0	0.3	5.3	160	135	8.5	12.5	0.2
45	Power Amplifier Triode	4D	14-1	2.5	1.5	10	275	—	4.0	3.0	7.0
<i>45A5</i>	Power Amplifier Pentode	8GW	T-X	45.0	0.1	9.0	250	250	11▲	8.3▲	1.0♣
<i>46Z5</i>	Half-Wave High-Vacuum Rectifier	5AM	5-2	45.0	0.075	—	Tube Voltage Drop: 23 v at 130 ma d-c				
45Z5-GT	Half-Wave High-Vacuum Rectifier	6AD	9-11	45.0	0.15	—	Tube Voltage Drop: 16 v at 200 ma d-c				
46	Dual-Grid Power Amplifier	5C	16-1	2.5	1.75	10	400	—	Single tube (G <sub>2</sub> & P tied)		
47	Power Amplifier Pentode	5B	16-1	2.5	1.75	—	250	250	8.6	13.0	1.2
48	Power Amplifier Tetrode	6A	16-1	30.0 DC	0.4	—	125	100	—	—	—
49	Dual-Grid Power Amplifier	5C	14-1	2.0 DC	0.12	—	135	—	Single tube (G <sub>2</sub> & P tied)		
50	Power Amplifier Triode	4D	T-X	7.5	1.25	25	450	—	4.2	3.4	7.1
50A5	Beam Power Amplifier	6AA	9-31	50.0	0.15	10	200	125	—	—	—
50AX6-G	Full-Wave High-Vacuum Rectifier	7Q	14-3	50.0	0.3	—	Tube Voltage Drop: 21 v at 250 ma d-c				
<i>50B5</i>	Beam Power Amplifier	7BZ	5-3	50.0	0.15	5.5	135	117	13.0▲	6.5▲	0.50▲
<i>50BK5</i>	Beam Power Amplifier	9BQ	6-3	50.0	0.15	9.0	250	250	13▲	5.0▲	0.6▲
<i>50C5</i>	Beam Power Amplifier	7CV	5-3	50.0	0.15	5.5	135	117	13.0▲	9.0▲	0.55▲

Metal tubes are shown in bold-face type, miniature tubes in italics.

♣Subminiature type.

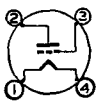

4D

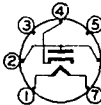

5AM

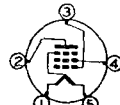

5B

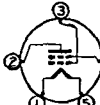

5C



5F



6A

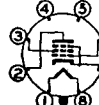

6AA

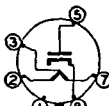

6AD

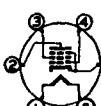

6B

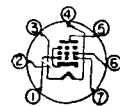

7BZ



7CV



7Q



8GW



9BQ



Service	Plate Volts	Screen Volts	Neg Grid Volts	Plate Milli-amperes	Screen Milli-amperes	R <sub>p</sub> , Ohms	G <sub>m</sub> , μmhos	μ Factor	Load for Rated Output, Ohms	Power Output, Watts	Tube Type
Class A Amplifier	250	90	3.0*	5.8	1.4	1,000,000	1,050	—	—	—	39/44
Class A Amplifier	180	—	3.0	0.2	—	150,000	200	30	250000	—	40
Class A Amplifier	250	250	18	32†	5.5†	90,000§	2,300	—	7,600	3.4	41
Class A Amplifier	285	285	20	38†	7.0†	78,000§	2,550	—	7,000	4.8	42
Class A Amplifier	160	120	18	33†	6.5†	42,000	2,375	—	5,000	2.2	43
Class A Amplifier	275	—	56	36†	—	1,700	2,050	3.5	4,600	2.0	45
Class A Amplifier	200	200	14.2	45	8.5	24,000	8,200	—	4,300	4.2	46A5
Half-Wave Rectifier	Max d-c output current = 65 ma; max peak inverse voltage = 350 v; max rms supply voltage = 117 volts; max peak current = 390 ma										46Z3
Half-Wave Rectifier	Max d-c output current = 100 ma; max peak inverse voltage = 700 volts; max rms supply voltage = 235 volts; max peak current = 600 ma. With panel lamp # 40 or # 47 between pins 2 and 3 and no shunting resistor, max d-c output current = 60 ma. With panel lamp and 250 ohm shunting resistor (max), max d-c output = 90 ma										45Z5-GT
Class A Amplifier	250	—	33	22†	—	2,380	2,350	5.6	6,400	1.25	46
Class A Amplifier	250	250	16.5	31†	6.0†	60,000	2,500	—	7,000	2.7	47
Class A Amplifier	125	100	20	56	9.5	—	3,900	—	1,500	2.5	48
Class A Amplifier	135	—	20	6.0	—	4,175	1,125	4.7	11,000	0.170 §	49
Class A Amplifier	450	—	84	55	—	1,800	2,100	3.8	4,350	4.6	50
Class A Amplifier	200	125	R <sub>k</sub> = 180	46†	2.2†	28,000§	8,000	—	4,000	3.8	50A5
Class A Amplifier	110	110	7.5	49†	4.0†	13,000§	8,000	—	2,000	2.1	
Full-Wave Rectifier	Max d-c output current = 250 ma; max peak inverse voltage = 1250 volts; rms supply voltage per plate = 350 volts; max peak current per plate = 600 ma										50AX6-G
TV Damp-er Service <sub>3</sub>	Max d-c output current per plate = 125 ma; max peak inverse voltage = 2000 volts; max peak current per plate = 600 ma										
Class A Amplifier	110	110	7.5	49†	4.0†	10,000§	7,500	—	2,500	1.9	60B6
Class A Amplifier	250	250	5.0	3.5†	3.5†	100,000§	8,500	—	6,500	3.5	60BK6
Class A Amplifier	110	110	7.5	49†	4.0†	10,000§	7,500	—	2,500	1.9	60C6

§ Approximate.

▲ Without external shield.

† Zero signal.

♦ Grids 3 and 5 are screen. Grid 4 is signal-input grid.

# Conversion transconductance.

♣ Maximum.

▼ Grids 2 and 4 are screen. Grid 3 is signal-input grid.

✱ Screen supply voltage.

☐ Absolute maximum rating.

† Plate-to-plate.

♣ Per section.

◆ Design maximum rating.

Ⓢ For both sections.

\* Minimum.

† Heater warm-up time controlled for series-string service.

‡ Plate supply voltage.

|| Input plate.

§—The duration of the pulse voltage must not exceed 15 percent of one scanning cycle.

1—Section 1.

2—Section 2.

4—A resistor of 3 ohms must be put in series with heater.

Tube Type	Classification by Construction	Base Connections	Out-line Dwg	Fila-ment Volts	Fila-ment Amp	Max Plate Watts	Max Plate Volts	Max Screen Volts	Capacitance in Micromicrofarads		
									Input	Out-put	Grid-plate
50C6-G 50C6-GA	Beam Power Amplifier	7AC	14-3 T-X	50	0.15	12.5	200	200*	—	—	—
50CD6-G	Beam Power Amplifier	5BT	16-5	50.0	0.3	15	700‡	175	25▲	9.5▲	0.6▲
50L6-GT	Beam Power Amplifier	7AC	9-11 or 9-41	50.0	0.15	10	200	125	—	—	—
50X6	High-Vacuum Rectifier-Doubler	7AJ	9-31	50.0	0.15	—	Tube Voltage Drop: ♦ 22 v at 150 ma d-c				
50Y6-GT	High-Vacuum Rectifier-Doubler	7Q	9-11	50.0	0.15	—	Tube Voltage Drop: ♦ 22 v at 150 ma d-c				
50Y7-GT	High-Vacuum Rectifier-Doubler	8AN	9-11 or 9-41	50.0	0.15	—	Tube Voltage Drop: ♦ 22 v at 150 ma d-c				
50Z6-G	High-Vacuum Rectifier-Doubler	7Q	14-3	50.0	0.3	—	—	—	—	—	—
50Z7-G	High-Vacuum Rectifier-Doubler	8AN	12-7	50.0	0.15	—	Tube Voltage Drop: ♦ 21 v at 130 ma d-c				
53	Twin Triode Power Amplifier	7B	14-1	2.5	2.0	1.0♦	300	—	Both Sections in Push-pull Both Sections in Parallel		
55	Duplex-Diode Medium-Mu Triode	6G	12-6	2.5	1.0	—	250	—			
56	Medium-Mu Triode	5A	12-5	2.5	1.0	1.3	250	—			
57	Sharp-Cutoff Pentode	6F	12-2	2.5	1.0	0.75 1.75	300 250	125	Pentode Connection Triode Connection (G <sub>2</sub> , G <sub>3</sub> , & P Tied)		
58	Remote-Cutoff RF Pentode	6F	12-2	2.5	1.0	2.25	300	100	—	—	—
59	Power Amplifier Pentode	7A	16-1	2.5	2.0	10	250	250	—	—	—
70A7-GT	Half-Wave Rectifier Beam Power Amplifier	8AB	9-11	70.0	0.15	—	110	110	—	—	—
									Tube Voltage Drop: 14 v at 120 ma d-c		

Metal tubes are shown in bold-face type, miniature tubes in *italics*. ©Subminiature type.

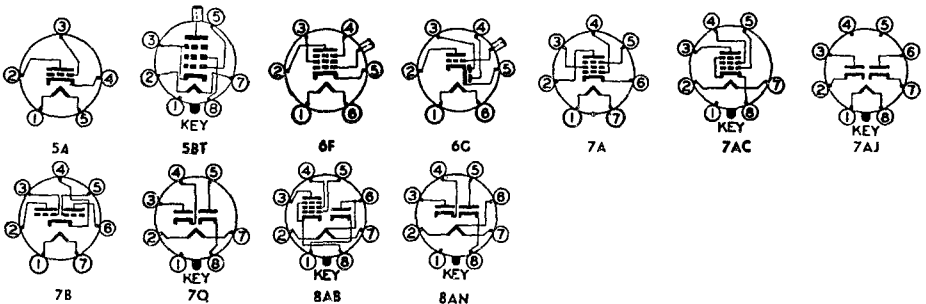

Service	Plate Volts	Screen Volts	Neg Grid Volts	Plate Milli-amperes	Screen Milli-amperes	R <sub>p</sub> ' Ohms	G <sub>m</sub> ' μmhos	μ Factor	Load for Rated Output, Ohms	Power Output, Watts	Tube Type
Class A Amplifier	135 200	135 135	13.5 14	58† 61†	3.5† 2.2†	9,300§ 18,300§	7,000 7,100	—	2,000 2,600	3.6 6.0	50C6-G 50C6-GA
Horizontal Deflection Amplifier	175 60	175 100	30 0	75 230	5.5 21	7,200§	7,700	—	—	—	50CD6-G
	Max positive pulse plate voltage; ⊕ = 6600 volts; max screen dissipation = 3.0 watts; max d-c cathode current = 200 ma										
Class A Amplifier	200 110	125 110	R <sub>k</sub> = 180 7.5	46† 49†	2.2† 4.0†	28,000§ 13,000§	8,000 8,000	—	4,000 2,000	3.8 2.1	50L6-GT
Rectifier or Doubler	Max d-c output current per plate = 75 ma; max peak inverse voltage = 700 volts; rms supply voltage per plate = 235 volts; max peak current per plate = 450 ma										50X6
Rectifier or Doubler	Max d-c output current per plate = 75 ma; max peak inverse voltage = 700 volts; max rms supply voltage per plate = 235 volts; max peak current per plate = 450 ma										50Y6-GT
Rectifier or Doubler	Max d-c output current per plate = 75 ma; max peak inverse voltage = 700 volts; max rms supply voltage per plate = 235 volts; max peak current per plate = 450 ma With panel lamp # 40 or # 47 between pins 6 and 7 and no shunting resistor, max d-c output current per plate = 60 ma. With panel lamp and 250 ohm shunting resistor (max), max d-c output per plate = 65 ma.										50Y7-GT
Rectifier or Doubler	Max d-c output current per plate = 125 ma; max peak inverse voltage = 700 volts; max rms supply voltage per plate = 235 volts; max peak current per plate = 750 ma										50Z6-G
Rectifier or Doubler	Max d-c output current per plate = 65 ma; max peak inverse voltage = 700 volts; max rms supply voltage per plate = 235 volts; max peak current per plate = 400 ma. Ratings also apply with panel lamp 292 or 292A between pins 6 and 7.										50Z7-G
Class B Amplifier	300	—	0.0	17.5†	—	—	—	—	8,000	10§	53
Class A Amplifier	294	—	6.0	7.0	—	11,000	3,200	35	—	—	53
Class A Amplifier	250	—	20	8.0†	—	7,500	1,100	8.3	20,000	0.350	55
Class A Amplifier	250	—	13.5	5.0	—	9,500	1,450	13.8	—	—	56
Class A Amplifier	250	100	3.0	2.0	0.5	1,000,000*	1,225	—	—	—	57
Class A Amplifier	250	—	8.0	6.5	—	10,500	1,900	20	—	—	57
Class A Amplifier	250	100	3.0	8.2	2.0	800,000§	1,600	—	—	—	58
Class A Amplifier	250	250	18	35	9.0	40,000	2,500	—	6,000	3.0	59
Class A Amplifier	110	110	7.5	40†	3.0†	—	5,800	—	2,500	1.5	70A7-GT
Half-Wave Rectifier	Max d-c output current = 60 ma; max rms supply voltage = 125 volts. A panel lamp must be connected between pins 6 and 7.										

§ Approximate.

▲ Without external shield.

† Zero signal.

‡ Grids 3 and 5 are screen. Grid 4 is signal-input grid.

# Conversion transconductance.

♣ Maximum.

♦ Grids 2 and 4 are screen. Grid 3 is signal-input grid.

\* Screen supply voltage.

⊕ Absolute maximum rating.

‡ Plate-to-plate.

♣ Per section.

◆ Design maximum rating.

⊕ For both sections.

\* Minimum.

¶ Heater warm-up time controlled for series-string service.

§ Plate supply voltage.

|| Input plate.

♣—The duration of the pulse voltage must not exceed 15 percent of one scanning cycle.

1—Section 1.

2—Section 2.

4—A resistor of 3 ohms must be put in series with heater.

Tube Type	Classification by Construction	Base Connections	Out-line Dwg	Fila-ment Volts	Fila-ment Amp	Max Plate Watts	Max Plate Volts	Max Screen Volts	Capacitance in Micromicrofarads		
									Input	Out-put	Grid-plate
70L7-GT	Half-Wave Rectifier Beam Power Amplifier	8AA	9-15	70.0	0.15	—	117	117	—	—	—
									Tube Voltage Drop: 20 v at 140 ma d-c		
71-A	Power-Amplifier Triode	4D	14-1	5.0	0.25	—	180	—	3.2	2.9	7.5
75	Duplex-Diode High-Mu Triode	6G	12-6	6.3	0.3	—	250	—	—	—	—
76	Medium-Mu Triode	5A	12-5	6.3	0.3	—	250	—	3.5	2.5	2.8
77	Sharp-Cutoff Pentode	6F	12-6	6.3	0.3	0.75	300	100	4.7▲	11.0▲	0.007
78	Remote-Cutoff RF Pentode	6F	12-6	6.3	0.3	2.75	300	150	4.5	11.0	0.007
									◆		
79	Twin-Triode Power Amplifier	6H	12-6	6.3	0.6	11.5⊕	250	—	Both Sections in Push-pull		
80	Full-Wave High-Vacuum Rectifier	4C	14-1	5.0	2.0	—	Tube Voltage Drop: ◆ 60 v at 125 ma d-c				
81	Half-Wave High-Vacuum Rectifier	4B	T-X or 16-1	7.5	1.25	—	Tube Voltage Drop: 91 v at 170 ma d-c				
82	Full-Wave Mercury-Vapor Rectifier	4C	14-1	2.5	3.0	—	Tube Voltage Drop: § 15 v				
83	Full-Wave Mercury-Vapor Rectifier	4C	16-1	5.0	3.0	—	Tube Voltage Drop: § 15 v				
83-V	Full-Wave High-Vacuum Rectifier	4AD	14-1	5.0	2.0	—	Tube Voltage Drop: ◆ 25 v at 175 ma d-c				
84/6Z4	Full-Wave High-Vacuum Rectifier	5D	12-5	6.3	0.5	—	Tube Voltage Drop: ◆ 20 v at 60 ma d-c				
85	Duplex Diode Medium-Mu Triode	6G	12-6	6.3	0.3	—	250	—	1.5	4.3	1.5
89	Power-Amplifier Pentode	6F	12-6	6.3	0.4	—	250	—	Triode connection (G <sub>1</sub> , G <sub>2</sub> , & P tied) Pentode connection		
							250	250			
V99 X99	Low-Mu Triode	4E 4D	T-X 9-25	3.3 DC	0.063	—	90	—	2.5	2.5	3.3
117L7/ M7-GT	Half-Wave Rectifier Beam Power Amplifier	8AO	9-15	117	0.09	6.0	117	117	—	—	—
									Tube Voltage Drop: 16 v at 150 ma d-c		
117N7-GT	Half-Wave Rectifier Beam Power Amplifier	8AV	9-15	117	0.09	5.5	117	117	—	—	—
									Tube Voltage Drop: 16 v at 150 ma d-c		

Metal tubes are shown in bold-face type, miniature tubes in italics.

⊕ Subminiature type.

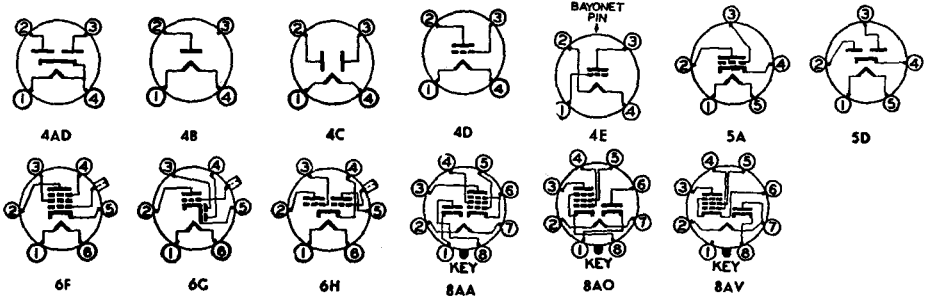

Service	Plate Volts	Screen Volts	Neg Grid Volts	Plate Milli-amperes	Screen Milli-amperes	R <sub>p</sub> , Ohms	G <sub>m</sub> , μmhos	μ Factor	Load for Rated Output, Ohms	Power Output, Watts	Tube Type
Class A Amplifier Half-Wave Rectifier	110	110	7.5	40†	3.0†	15,000	7,500	—	2,000	1.8	70L7-GT
	Max d-c output current = 70 ma; max peak inverse voltage = 350 volts; max rms supply voltage = 117 volts; max peak current = 420 ma										
Class A Amplifier	180	—	40.5	20†	—	1,750	1,700	3.0	4,800	0.790	71-A
Class A Amplifier	250	—	2.0	0.9	—	91,000§	1,100	100	—	—	75
Class A Amplifier	250	—	13.5	5.0	—	9,500	1,450	13.8	—	—	76
Class A Amplifier	250	100	3.0	2.3	0.5	1,000,000*	1,250	—	—	—	77
Class A Amplifier	250	125	3.0	10.5	2.6	600,000§	1,650	—	—	—	78
Class B Amplifier	250	—	0	10.5†	—	Input signal = .380 watt		—	14,000	8.0§	79
	‡										
Full-Wave Rectifier	Max d-c output current = 125 ma; max peak inverse voltage = 1400 volts; rms supply voltage per plate = 350 volts; max peak current per plate = 400 ma										80
Half-Wave Rectifier	Max d-c output current = 85 ma; max peak inverse voltage = 2000 volts; max rms supply voltage = 700 volts; max peak current = 500 ma										81
Full-Wave Rectifier	Max d-c output current = 115 ma; max peak inverse voltage = 1,550 volts; max rms supply voltage per plate = 450 volts; max peak current per plate = 600 ma										82
Full-Wave Rectifier	Max d-c output current = 225 ma; max peak inverse voltage = 1,550 volts; max rms supply voltage per plate = 450 volts; max peak current per plate = 1,000 ma										83
Full-Wave Rectifier	Max d-c output current = 175 ma; max peak inverse voltage = 1400 volts; max rms supply voltage per plate = 375 volts; max peak current per plate = 525 ma										83-V
Full-Wave Rectifier	Max d-c output current = 60 ma; max peak inverse voltage = 1,250 volts; max rms supply voltage per plate = 325 volts; max peak current per plate = 180 ma										84/6Z4
Class A Amplifier	250	—	20	8†	—	7,500	1,100	8.3	20,000	0.350	85
Class A Amplifier	250	—	31	32†	—	2,600	1,800	4.7	5,500	0.900	89
Class A Amplifier	250	250	25	32†	5.5†	70,000	1,800	—	6,750	3.4	
Class A Amplifier	90	—	4.5	2.5	—	15,500	425	6.6	—	—	V99 X99
Class A Amplifier Half-Wave Rectifier	105	105	5.2	43†	4†	17,000§	5,300	—	4,000	0.85	117L7/ M7-GT
	Max d-c output current = 75 ma; max peak inverse voltage = 350 volts; max rms supply voltage = 117 volts; max peak current = 450 ma										
Class A Amplifier Half-Wave Rectifier	100	100	6.0	51†	5†	16,000§	7,000	—	3,000	1.2	117N7-GT
	Max d-c output current = 75 ma; max peak inverse voltage = 350 volts; max rms supply voltage = 117 volts; max peak current = 450 ma										

§ Approximate.

▲ Without external shield.

† Zero signal.

♦ Grids 3 and 5 are screen. Grid 4 is signal-

input grid.

# Conversion transconductance.

♣ Maximum.

▼ Grids 2 and 4 are screen. Grid 3 is signal-

input grid.

\* Screen supply voltage.

⊙ Absolute maximum rating.

‡ Plate-to-plate.

♣ Per section.

⊕ Design maximum rating.

⊕ For both sections.

\* Minimum.

† Heater warm-up time controlled for series-string service.

‡ Plate supply voltage.

|| Input plate.

♣ The duration of the pulse voltage must not exceed 15 percent of one scanning cycle.

1—Section 1.

2—Section 2.

4—A resistor of 3 ohms must be put in series with heater.

Tube Type	Classification by Construction	Base Connections	Out-line Dwg	Fila-ment Volts	Fila-ment Amp	Max Plate Watts	Max Plate Volts	Max Screen Volts	Capacitance in Micromicrofarads		
									Input	Out-put	Grid-plate
117P7-GT	Half-Wave Rectifier Beam Power Amplifier	8AV	9-15	117	0.09	6.0	117	117	—	—	—
<i>117Z3</i>	Half-Wave High-Vacuum Rectifier	4CB	5-3	117	0.04	—	Tube Voltage Drop: 16 v at 150 ma d-c				
117Z4-GT	Half-Wave High-Vacuum Rectifier	5AA	9-5	117	0.04	—	Tube Voltage Drop: 22.5 v at 180 ma d-c				
117Z6-GT	High-Vacuum Rectifier Doubler	7Q	9-11	117	0.075	—	Tube Voltage Drop: ♦ 15.5 v at 120 ma d-c				
182-B/ 482B	Power Amplifier Triode	4D	14-1	5.0	1.25	—	250	—	—	—	—

Metal tubes are shown in bold-face type, *miniature tubes in italics.*      ♦Subminiature type.

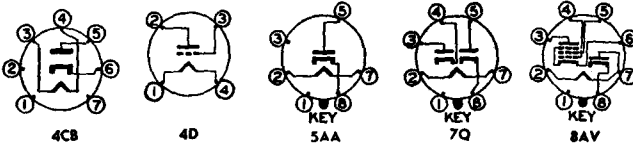

Service	Plate Volts	Screen Volts	Neg Grid Volts	Plate Milli-amperes	Screen Milli-amperes	R <sub>p</sub> , Ohms	G <sub>m</sub> , $\mu$ mhos	$\mu$ Factor	Load for Rated Output, Ohms	Power Output, Watts	Tube Type
Class A Amplifier Half-Wave Rectifier	105	105	5.2	43†	4†	17,000§	5,300	—	4,000	0.85	117P7-GT
Half-Wave Rectifier	Max d-c output current = 75 ma; max peak inverse voltage = 350 volts; max rms supply voltage = 117 volts; max peak current = 450 ma										
Half-Wave Rectifier	Max d-c output current = 90 ma; max peak inverse voltage = 330 volts; max rms supply voltage = 117 volts; max peak current = 540 ma										
Half-Wave Rectifier	Max d-c output current = 90 ma; max peak inverse voltage = 350 volts; max rms supply voltage = 117 volts; max peak current = 540 ma										
Rectifier or Doubler	Max d-c output current per plate = 60 ma; max peak inverse voltage = 700 volts; max rms supply voltage per plate = 235 volts; max peak current per plate = 360 ma										
Class A Amplifier	250	—	35	18	—	—	1,500	5.0	—	—	182-B/482B

§ Approximate.

▲ Without external shield.

† Zero signal.

◆ Grids 3 and 5 are screen. Grid 4 is signal-

input grid.

# Conversion transconductance.

♣ Maximum.

♥ Grids 2 and 4 are screen. Grid 3 is signal-

input grid.

✱ Screen supply voltage.

⊖ Absolute maximum rating.

‡ Plate-to-plate.

♣ Per section.

⊕ Design maximum rating.

⊕ For both sections.

\* Minimum.

¶ Heater warm-up time controlled for series-string service.

‡ Plate supply voltage.

|| Input plate.

3—The duration of the pulse voltage must not exceed 15 percent of one scanning cycle.

1—Section 1.

2—Section 2.

4—A resistor of 3 ohms must be put in series with heater.





# CLASSIFICATION CHART—FIVE-STAR TYPES

## Special-Quality Tubes for Critical Applications

Classification			Sub-Miniature	7-Pin Miniature	9-Pin Miniature	Metal	Octal
DIODES	Low-Current Rectifiers		5896	5726			
	Full-Wave Power Rectifiers			6202	6203		6087
TRIODES	Single	$\mu < 40$	5718	6135			
		$\mu > 40$	5719				
	Twin	$\mu < 40$	6021 6111		5670 5814-A 6386		
		$\mu > 40$	6112		5751 6072 6201 6414 6829		
PENTODES	Voltage Amplifiers	Sharp-Cutoff	5840 6205	5654 6136 6265		6134	
		Remote-Cutoff	5899	5749		6137	
		Dual-Control	5636	5725			
	Power Amplifiers		5902	6005	5686		
HEPTODES				5750			
THYRATRONS				5727			

Special-Purpose Tubes

# CLASSIFICATION CHART—SPECIAL-PURPOSE TYPES

Category	DIODES		TRIODES		PENTODES			HEP-TODES	TRI-ODE-PEN-TODES	THY-RAT-RONS
	High Voltage	Twin	Single	Twin	Sharp-Cutoff	Re-mote-Cutoff	Power Amplifier	Dual Control		
Computer Types				5844 5963 5964 5965 6211 6463				5915-A		6525
Low-Microphonic Types				12AY7	1620 5879			1612		
Mobile Communications Types		6663		6679 6680 6681	6661	6660 6662	6669 6677		6678	
Low-Power Transmitting Types							2E30 807			
Miscellaneous Types	2X2-A	5R4-GY 5R4-GYA	6J4 5810 9002	5687 5681 5692	6AS6 6693 6485 9001	9003	6AN5 5824 5881 6046			2D21 6D4 502-A
Cold-Cathode (Glow-Discharge) Types	VOLTAGE REGULATORS				GAS-TRIODE					
	75 Volts	90 Volts	105 Volts	150 Volts						
	OA3	OB3	OB2 OC3	OA2 OD3	OA4-G					

Tube Type	Classification by Construction	Base Connections	Out-line Dwg	Fila-ment Volts	Fila-ment Amp	Max Plate Watts	Max Plate Volts	Max Screen Volts	Capacitance in Micromicrofarads		
									Input	Out-put	Grid-plate
183/483	Power Amplifier Triode	4D	14-1	5.0	1.25	—	250	—	—	—	—
485	Medium-Mu Triode	5A	12-5	3.0	1.25	—	180	—	—	—	—
502-A	Thyratron	6BS	8-1	6.3	0.6	—	Anode voltage drop = 8 volts				
512AX	AF Pentode	512AX	2-2	0.625	0.02	—	45	45	2.0▲	1.5▲	0.045▲
807	Beam Power Amplifier	5AW	16-2	6.3	0.9	25☐ 25☐	400 600	— 300	Triode Connection Two Tubes, Push-pull Pentode Connection Two Tubes, Push-pull		
950	Power Amplifier Pentode	5K	14-1	2.0 DC	0.12	—	135	135	—	—	—
954	Detector Amplifier Pentode (Acorn)	5BB	4-3	6.3	0.15	1.5	250	100	3.4	3.0	0.007♣
955	Medium-Mu Triode (Acorn)	5BC	4-1	6.3	0.15	1.6	250	—	1.0▲	0.4▲	1.3▲
						—	180	—	—	—	—
956	Remote-Cutoff RF Pentode (Acorn)	5BB	4-3	6.3	0.15	1.7	250	100	3.1	2.5	0.009♣
957	Medium-Mu Triode (Acorn)	5BD	4-1	1.25 DC	0.05	—	135	—	0.25	0.5	1.1
958-A	Medium-Mu Triode (Acorn)	5BD	4-1	1.25 DC	0.1	0.6	135	—	0.45	0.6	2.5
						—	135	—	—	—	—
959	Sharp-Cutoff Pentode (Acorn)	5BE	4-3	1.25 DC	0.05	—	145	67.5	1.8	2.5	0.015♣
1612	Pentagrid Mixer (Special 6L7)	7T	8-4	6.3	0.3	1.5	250	100	—	—	—
1620	Sharp-Cutoff Pentode (Special 6J7)	7R	8-4	6.3	0.3	—	250	100	7.0	12.0	0.005♣
1621	Power-Amplifier Pentode (Special 6F6)	7S	8-6	6.3	0.7	7.9	300	300	2 tubes, Push-pull		
1622	Beam Power Amplifier (Special 6L6)	7AC	10-1	6.3	0.9	13.8	300	250	2 tubes, Push-pull		
1629	Electron-Ray Indicator	7AL	T-X	12.6	0.15	—	250	Max target voltage = 250 Min target voltage = 125			
1631	Beam Power Amplifier	7AC	10-1	12.6	0.45	16	360	270	2 tubes, Push-pull		
1632	Beam Power Amplifier	7AC	8-6	12.6	0.6	5.5	117	117	—	—	—

Metal tubes are shown in bold-face type, miniature tubes in *italics*.

☉Subminiature type.

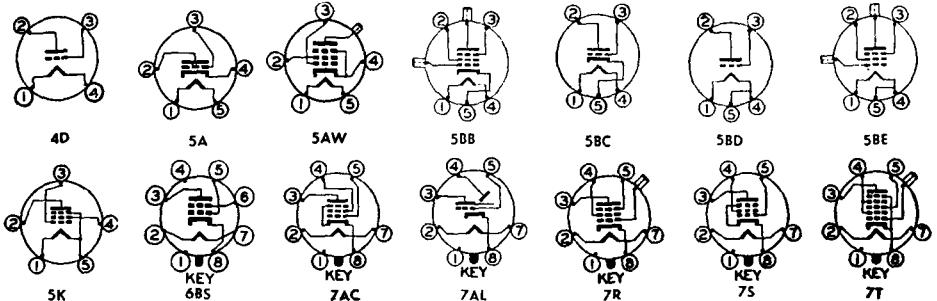

Service	Plate Volts	Screen Volts	Neg Grid Volts	Plate Milli-am-peres	Screen Milli-am-peres	R <sub>p</sub> ' Ohms	G <sub>m</sub> ' μmhos	μ Factor	Load for Rated Output, Ohms	Power Output, Watts	Tube Type
Class A Amplifier	250	—	60	30	—	1,750	1,700	3.0	—	—	183/483
Class A Amplifier	180	—	9.0	5.8	—	8,900	1,400	12.5	—	—	485
Controlled Rectifier	Max d-c cathode current $\square = 100$ ma; max peak inverse voltage $\square = 1,300$ volts; max peak cathode current $\square = 1.0$ ampere										502-A
Class A Amplifier	22.5	22.5	0.625	0.125	0.040	1,250,000	160	—	—	—	512AX $\odot$
Class AB <sub>1</sub> Amplifier	400	—	45	60†	—	—	—	—	3,000‡	30§	807
Class AB <sub>2</sub> Amplifier	600	300	30	60†	5.0†	—	—	—	6,400‡	80§	
Class A Amplifier	135	135	16.5	7.0†	2.0†	105,300	950	—	13,500	0.450	950
Class A Amplifier	250 90	100 90	3.0 3.0	2.0 1.2	0.7 0.5	1,000,000* 1,000,000	1,400 1,100	— —	— —	— —	954
Class A Amplifier	250	—	7.0	6.3	—	11,400	2,200	25	—	—	955
Class C Amplifier	180	—	5.0	4.5†	—	12,500	2,000	25	20,000	0.135	
	90	—	2.5	2.5	—	14,700	1,700	25	—	0.5	
Class A Amplifier	250	100	3.0	6.7	2.7	700,000§	1,800	—	—	—	956
Class A Amplifier	135	—	5.0	2.0	—	20,800§	650	13.5	—	—	957
Class A Amplifier	135	—	7.5	3.0	—	10,000§	1,200	12	—	—	958-A
Class C Amplifier	135	—	20	7.0	—	Input signal = 0.035 watt		—	—	0.6	
Class A Amplifier	135	67.5	3.0	1.7	0.4	800,000§	600	—	—	—	959
Class A Amplifier	250	100	3.0	5.3	6.5	600,000	1,100	E <sub>cs</sub> = -3.0 volts		—	1612
Class A Amplifier	250 100	100 100	3.0 3.0	2.0 2.0	0.5 0.5	1,000,000* 1,000,000	1,225 1,185	— —	— —	— —	1620
Class A Amplifier	300	300	30	38†	6.5†	—	—	—	4,000‡	5	1621
Class A Amplifier	300	250	20	86†	4†	—	—	—	4,000‡	10	1622
Tuning Indicator	Plate voltage = 250 thru 1 meg; Target voltage = 250 (E <sub>g</sub> = -8 volts; Shadow = 0°) (E <sub>g</sub> = 0 volts, Shadow = 90°; Plate current = 0.24 ma, Target current § = 4 ma)										1629
Class AB <sub>1</sub> Amplifier	360	270	22.5	88†	5†	—	—	—	6,600‡	26.5	1631
Class A Amplifier	110	110	7.5	49†	4†	13,000§	9,000	—	2,000	2.1	1632



512-AX

- § Approximate.
- ▲ Without external shield.
- † Zero signal.
- ‡ Grids 3 and 5 are screen. Grid 4 is signal-input grid.
- # Conversion transconductance.
- ◆ Maximum.
- ♥ Grids 2 and 4 are screen. Grid 3 is signal-input grid.
- ✱ Screen supply voltage.
- ◻ Absolute maximum rating.
- ‡ Plate-to-plate.
- ◆ Per section.
- ◊ Design maximum rating.

- ⊗ For both sections.
- \* Minimum.
- ¶ Heater warm-up time controlled for series-string service.
- § Plate supply voltage.
- || Input plate.
- ||—The duration of the pulse voltage must not exceed 15 percent of one scanning cycle.
- 1—Section 1.
- 2—Section 2.
- ⊖ A resistor of 3 ohms must be put in series with heater.

Tube Type	Classification by Construction	Base Con- nections	Out- line Dwg	Fila- ment Volts	Fila- ment Amp	Max Plate Watts	Max Plate Volts	Max Screen Volts	Capacitance in Micromicrofarads		
									Input	Out- put	Grid- plate
1633	Medium-Mu Twin Triode	8BD	9-11	25.0	0.15	2.5♣	300	—	—	—	—
1634	High-Mu Twin Triode (Special 12SC7)	8S	8-1	12.6	0.15	—	250	—	—	—	—
1635	Twin-Triode Power Amplifier	8B	9-11	6.3	0.6	3.0♣	300	—	Both sections in push-pull		
1644	Twin-Pentode Power Amplifier (Special 12L8-GT)	8BU	9-11	12.6	0.15	2.5♣	180	180	5.0▲	6.0▲	0.7▲
1664	Half-Wave High-Vacuum Rectifier	2Z	T-X	1.4	0.05	—	—	—	—	—	—
5590	RF Pentode	7BD	5-1	6.3	0.15	1.7	180	140	3.40	2.90	0.01
5591	Sharp-Cutoff RF Pentode (Special 6AK5)	7BD	5-1	6.3	0.15	1.7	180	140	4.0	2.8	0.02♣
5608-A	Medium-Mu Twin-Triode	7B	14-1	2.5	2.0	5.5♣	350	—	—	—	—
5610	Medium-Mu Triode	6CG	5-2	6.3	0.15	3.0	300	—	—	—	—
5633♣	Remote-Cutoff RF Pentode	5633	T-X	6.3	0.15	0.8	150	140	4.0▲	2.2▲	0.015♣▲
5634♣	Remote-Cutoff RF Pentode	5633	T-X	6.3	0.15	0.8	150	140	4.4▲	2.2▲	0.015♣▲
5635♣	Medium-Mu Twin Triode	8DB	3-1	6.3	0.45	1.25♣	150	—	2.6	1.6	1.2
5636♣	Dual-Control Pentode	8DC	3-1	6.3	0.15	0.65♣	165♣	155♣	—	—	—
5637♣	High-Mu Triode	5637	3-2	6.3	0.15	0.3	150	—	2.6▲	0.7▲	1.4▲
5638♣	Amplifier Pentode	5638	3-2	6.3	0.15	0.6	150	140	4.0	6.5	0.19
5639♣	Video Pentode	8DL	3-3	6.3	0.45	3.8♣	165♣	155♣	9.5	7.5	0.10♣
5640♣	Beam Power Amplifier	5640	3-4	6.3	0.45	3.5	150	140	9.0	7.0	0.18
5641♣	Half-Wave Rectifier	6CJ	3-3	6.3	0.45	—	Tube Voltage Drop: 23 v at 90 ma d-c				
5642♣	Half-Wave High-Voltage Rectifier	5642	T-X	1.25	0.2	—	Tube Voltage Drop: 30 v at 4.0 ma d-c				
5645♣	Medium-Mu Triode	5645	T-X	6.3	0.15	1.0	150	—	2.2	3.0	1.7

Metal tubes are shown in bold-face type, miniature tubes in *italics*.      ♣Subminiature type.

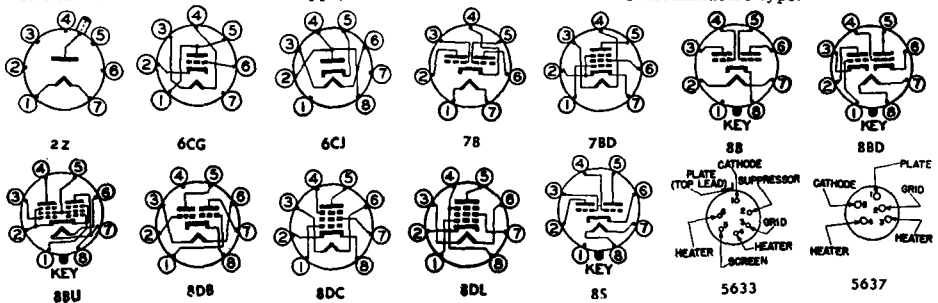

Service	Plate Volts	Screen Volts	Neg Grid Volts	Plate Milli-am-peres	Screen Milli-am-peres	$R_p$ , Ohms	$G_m$ , $\mu$ mhos	$\mu$ Factor	Load for Rated Out-put, Ohms	Power Out-put, Watts	Tube Type
Class A Amplifier ♠	250	—	8	11.5	—	6,900	2,600	18	—	—	1633
Class A Amplifier ♠	250	—	2	2.0	—	53,000§	1,325	70	—	—	1634
Class B Amplifier	300	—	0	6.6†	—	—	—	—	12,000 †	10.4	1635
Class A Amplifier ♠	180	180	9	13†	2.8†	160,000	2,150	—	10,000	1.0	1644
Half-Wave Rectifier	Max d-c output current = 1.0 ma; max peak inverse voltage = 4,300 volts; rms supply voltage = 1,500 volts; max peak current = 6 ma										1654
Class A Amplifier	90	90	$R_k = 820$	3.9	1.4	300,000	2,000	—	—	—	5590
Class A Amplifier	180	120	$R_k = 180$ $R_k = 180$	7.7	2.4	500,000§	5,100	—	—	—	5591
	120	120		7.5	2.5	300,000§	5,000	—	—	—	
Class A Amplifier ♠	300	—	6.0	6.0	—	13,000	2,450	32	—	—	5608-A
Class A Amplifier	90	—	1.5	17	—	3,500	4,000	14	—	—	5610
Class A Amplifier	100	100	$R_k = 150$	7.0	2.8	200,000	3,400	—	—	—	5633 ●
Class A Amplifier	100	100	$R_k = 150$	6.5	2.5	240,000§	3,500	—	—	—	5634 ●
Class A Amplifier ♠	100	—	$R_k = 100 \oplus$	4.8	—	10,000	3,800	38	—	—	5635 ●
Gated Amplifier	100	100	$R_k = 150$ $R_k = 150$	5.3	3.6	110,000§	3,200	G <sub>2</sub> tied to cathode			5636 ●
	100	100		4.0	5.8	50,000§	1,950	E <sub>c3</sub> = -1.0 volts			
Class A Amplifier	100	—	$R_k = 820$	1.4	—	26,000	2,700	70	—	—	5637 ●
Class A Amplifier	100	100	$R_k = 270$	4.8	1.25	150,000	3,300	—	—	—	5638 ●
Class A Amplifier	150	100	$R_k = 100$	21	4.0	50,000	9,000	—	—	—	5639 ●
Class A Amplifier	100	100	9.0	31†	2.2†	15,000	5,000	—	3,000	1.25	5640 ●
Half-Wave Rectifier	Max d-c output current $\square = 50$ ma; max peak inverse voltage $\square = 930$ volts; rms supply voltage per plate = 275 volts; max peak current $\square = 300$ ma										5641 ●
TV Flyback Rectifiers	Max d-c output current = 0.25 ma; max peak inverse voltage = 10,000 volts; max peak current = 5.0 ma										5642 ●
Class A Amplifier	100	—	$R_k = 560$	5.0	—	7,400	2,700	20	—	—	5645 ●

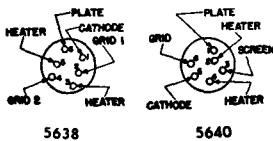

5638

5640

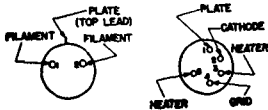

5642

5645

- ♠ Per section.
- § Approximate.
- † Zero Signal.
- ‡ Plate-to-plate.
- ▲ Without external shield.
- ◆ Maximum.
- ⊕ For both sections.
- ⊖ Absolute maximum rating.
- ⊔ The duration of the pulse voltage must not exceed 15 percent of one scanning cycle.
- ◆ Design maximum rating.

Tube Type	Classification by Construction	Base Connections	Out-line Dwg	Fila-ment Volts	Fila-ment Amp	Max Plate Watts	Max Plate Volts	Max Screen Volts	Capacitance in Micromicrofarads		
									Input	Out-put	Grid-plate
5646	High-Mu Triode	5645	T-X	6.3	0.15	0.3	150	—	2.2▲	1.0▲	1.3▲
5647	High-Frequency Diode	5647	T-X	6.3	0.15	—	Tube Voltage Drop: 2.8 v at 18 ma d-c				
6654	Sharp-Cutoff RF Pentode	7BD	5-1	6.3	0.175	1.55	200	155	4.0	2.9	0.02
6670	High-Frequency Twin Triode	8CJ	6-1	6.3	0.35	1.4	330	—	2.2▲	1.0▲	1.1▲
5672	Power Amplifier Pentode	5672	2-1	1.25 DC	0.05	—	90	90	—	—	—
5675	Medium-Mu Triode (Pencil)	5675	T-X	6.3	0.135	5.0	150	—	2.3▲	0.09▲	1.3▲
5676	Medium-Mu Triode	5676	T-X	1.25 DC	0.12	—	135	—	1.3	4.0	2.0
5677	Medium-Mu Triode	5677	T-X	1.25 DC	0.06	—	135	—	1.3	3.8	2.0
5678	Pentode Amplifier	1AD4	T-X	1.25 DC	0.05	—	90	67.5	3.3	3.8	0.01
5679	Twin Diode (Special 7A6)	7CX	9-30	6.3	0.15	—	Tube Voltage Drop: 11 v at 16 ma d-c				
6686	Beam Power Amplifier	9G	6-2	6.3	0.35	8.25	275	275	6.5	8.5	0.08
6687	Medium-Mu Twin Triode	9H	6-2	{ 6.3 12.6 }	{ 0.9 0.45 }	4.2	300	—	4.0▲	0.61▲ 0.52▲	4.0▲
5690	Full-Wave High-Vacuum Rectifier	5690	T-X	{ 12.6 6.3 }	{ 1.2 2.4 }	—	Tube Voltage Drop: 17 v at 150 ma d-c				
5691	High-Mu Twin Triode (Special 6SL7-GT)	8BD	9-37	6.3	0.6	1.0	275	—	—	—	—
5692	Medium-Mu Twin Triode (Special 6SN7-GT)	8BD	9-37	6.3	0.6	1.75	275	—	—	—	—
5693	Sharp-Cutoff Pentode (Special 6SJ7)	8N	8-1	6.3	0.3	2.0	300	125	5.3	6.2	0.005
5694	Medium-Mu Twin Triode	8CS	14-3	6.3	0.8	5.5	300	—	Both Sections in Parallel		
5702	RF Pentode	5702	3-7	6.3	0.2	—	180	140	4.4	3.5	0.03
5703	Medium-Mu Triode	5703	3-6	6.3	0.2	3.0	250	—	2.6	0.7	1.2
5704	Diode	5704	T-X	6.3	0.15	—	Tube Voltage Drop: 2 v at 9 ma d-c				

Metal tubes are shown in bold-face type, miniature tubes in *italics*.      ● Subminiature type.

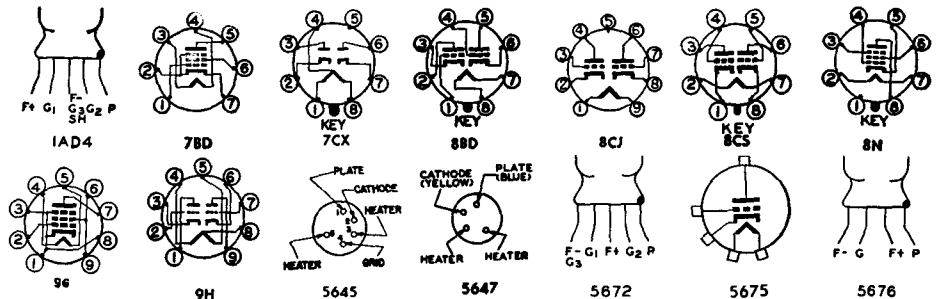

Service	Plate Volts	Screen Volts	Neg Grid Volts	Plate Milli-am-peres	Screen Milli-am-peres	R <sub>p</sub> , Ohms	G <sub>m</sub> , μmhos	μ Factor	Load for Rated Out-put, Ohms	Power Out-put, Watts	Tube Type
Class A Amplifier	100	—	R <sub>k</sub> = 820	1.4	—	29,000	2,400	70			5646 ●
Half-Wave Rectifier	Max d-c output current ⊕ = 10 ma; max peak inverse voltage ⊕ = 460 volts; max rms supply voltage ⊕ = 165 volts; max peak current ⊕ = 60 ma										5647 ●
Class A Amplifier	120	120	R <sub>k</sub> = 200	7.5	2.5	340,000§	5,000	—			5654
Class A Amplifier ♦	150	—	R <sub>k</sub> = 240	8.2	—	6,400‡	5,500	35	—	—	5670
Class A <sub>1</sub> Amplifier	300	—	R <sub>k</sub> = 800 ⊕	9.8†	—	—	—	—	27,000 ‡	1.0	
Class A Amplifier	67.5	67.5	6.5	3.25	1.1	—	650	—	20,000	0.065	5672 ●
Class A Amplifier	135	—	R <sub>k</sub> = 68	24	—	3,225	6,200	20	—	—	5675
Class A Amplifier	135	—	5.0	4.0	—	—	1,600	15	—	—	5676 ●
Class A Amplifier	135	—	6.0	1.9	—	—	650	13.5	—	—	5677 ●
Class A Amplifier	67.5	67.5	0	1.8	0.48	1,000,000	1,100	—	—	—	5678 ●
Half-Wave Rectifier	Max d-c output current per plate = 8 ma; max rms supply voltage per plate = 150 volts; max peak current per plate = 45 ma										5679
Class A Amplifier	250	250	12.5	27†	3.0†	45,000§	3,100	—	9,000	2.7	5686
Class C Amplifier	250	250	50	40	10.5	Input Signal = 0.15 watt§		—	—	6.5‡	
Class A Amplifier ♦	180	—	7.0	21	—	2,100	8,250	17.5	—	—	5687
	250	—	12.5	12.5	—	3,000‡	5,500	16.5	—	—	
Full-Wave Rectifier	Max d-c output current = 125 ma; max peak inverse voltage = 1,120 volts; rms supply voltage per plate = 350 volts; max peak current per plate = 375 ma										5690
Class A Amplifier ♦	250	—	2.0	2.3	—	44,000	1,600	70	—	—	5691
Class A Amplifier ♦	250	—	9.0	6.5	—	9,100	2,200	20	—	—	5692
Class A Amplifier	250	100	3.0	3.0	0.85	1,000,000 *	1,650	—	—	—	5693
Class A Amplifier	294	—	6.0	7.0	—	11,000	3,200	35	—	—	5694
	250	—	5.0	6.0	—	11,300	3,100	35	—	—	
Class A Amplifier	120	120	R <sub>k</sub> = 200	7.5	2.5	340,000	5,000	—			5702 ●
Class A Amplifier	120	—	R <sub>k</sub> = 220	9.0	—	—	5,000	25			5703 ●
Half-Wave Rectifier	Max d-c output current = 9 ma; max peak inverse voltage = 420 volts; max rms supply voltage = 150 volts; max peak current = 54 ma										5704 ●

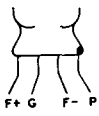

5677

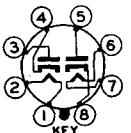

5690



5702

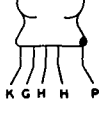

5703

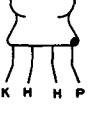

5704

- ▲ Without external shield.
- ⊕ Absolute maximum rating.
- ♦ Maximum.
- ◆ Per Section
- 1—Section 1.
- ⊕ For both sections.
- † Zero signal.
- ‡ Approximate.
- ‡ Plate-to-plate.
- †—Section 2.
- \* Minimum.
- ◆ Design maximum rating.

Tube Type	Classification by Construction	Base Connections	Out-line Dwg	Filament Volts	Filament Amp	Max Plate Watts	Max Plate Volts	Max Screen Volts	Capacitance in Micromicrofarads		
									Input	Output	Grid-plate
5718	Medium-Mu Triode	8DK	3-1	6.3	0.15	1.0	165	—	2.4	2.4	1.3
5719	High-Mu Triode	8DK	3-1	6.3	0.15	0.3	165	—	1.9	2.2	0.8
5725	Dual-Control RF Pentode	7CM	5-1	6.3	0.175	1.55	200	155	4.0	3.0	0.01
5726	Twin Diode	6BT	5-1	6.3	0.30	—	Tube Voltage Drop: 10 v at 60 ma d-c				
5727	Thyratron	7BN	5-2	6.3	0.6	—	Anode voltage drop = 8 volts				
5731	Power Amplifier Triode (Acorn)	5BC	4-1	6.3	0.15	—	250	—	1.0	0.4	1.3
5732	Remote-Cutoff RF Pentode (Special 6K7)	7R	8-4	6.3	0.3	2.75	300	125	7.0	12	0.005
5744	High-Mu Triode	5744	3-6	6.3	0.2	—	250	—	—	—	—
5749	Remote-Cutoff RF Pentode	7BK	5-2	6.3	0.3	3.1	330	150	5.5	5.5	0.0035
5760	Pentagrid Converter	7CH	5-2	6.3	0.3	1.1	330	110	Osc $I_{g1} = 0.5$ ma $R_{g1} = 20,000$ ohms		
5761	High-Mu Twin Triode	9A	6-2	{ 6.3 12.6 }	{ 0.35 0.175 }	0.7	330	—	1.4	0.46 0.36 <sub>2</sub>	1.4
5784	Dual-Control RF Pentode	5702	3-7	6.3	0.2	1.7	180	140	3.9	3.0	0.03
5785	Half-wave High-Voltage Rectifier	5785	T-X	1.25 DC	0.015	—	Tube Voltage Drop: 17 v at 0.1 ma d-c				
5797	Semi-Remote-Cutoff RF Pentode	8CY	3-2	26.5	0.045	0.8	50	50	4.2	3.2	0.024
5798	Medium-Mu Twin Triode	8CZ	3-2	26.5	0.09	0.2	50	—	1.9	1.7	1.7
5814 5814-A	Medium-Mu Twin Triode	9A	6-2	{ 6.3 12.6 }	{ 0.35 0.175 }	2.7	330	—	1.6	0.51 0.42	1.5
5824	Beam Power Amplifier (Special 25B6-G)	7AC	14-3 or 9-11 or 9-41	25.0	0.3	12.5	200	135	—	—	—
5825	Half-Wave High-Voltage Rectifier	4P	T-X	1.6	1.25	—	Tube Voltage Drop: 1,750 v at 40 ma d-c				
5829	Twin Diode	5829	2-3	6.3	0.15	—	Tube Voltage Drop: 5 v at 15 ma d-c				

Metal tubes are shown in bold-face type, miniature tubes in *italics*. ©Subminiature type.

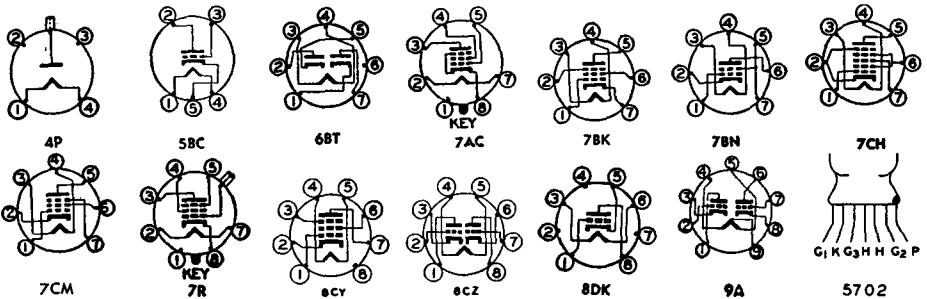



Service	Plate Volts	Screen Volts	Neg Grid Volts	Plate Milli-am-peres	Screen Milli-am-peres	$R_p$ , Ohms	$G_m$ , $\mu$ mhos	$\mu$ Factor	Load for Rated Output, Ohms	Power Output, Watts	Tube Type
Class A Amplifier	100	—	$R_k = 150$	8.5	—	4,650§	5,800	27	—	—	5718 ●
Class A Amplifier	100	—	$R_k = 1,500$	0.73	—	41,000§	1,700	70	—	—	5719 ●
Class A Amplifier	120	120	2.0	5.2	3.5	—	3,200	$E_{c3} = 0$ volts	—	—	5725
Half-Wave Rectifier	Max d-c output current per plate □ = 10 ma; max peak inverse voltage □ = 360 volts; rms supply voltage per plate = 117 volts; max peak current per plate □ = 60 ma										5726
Controlled Rectifier	Max d-c cathode current □ = 100 ma; max peak inverse voltage □ = 1,300 volts; max peak cathode current □ = 500 ma										5727
Class A Amplifier	250	—	7.0	6.3	—	11,400	2,200	25	—	—	5731
Class A Amplifier	250	100	3	7.0	1.7	800,000§	1,450	—	—	—	5732
Class A Amplifier	250	—	$R_k = 500$	4.0	—	—	4,000	70	—	—	5744 ●
Class A Amplifier	250	100	$R_k = 68$	11	4.2	1,000,000§	4,400	—	—	—	5749
	100	100	$R_k = 68$	10.8	4.4	250,000§	4,300	—	—	—	5749
Converter	250	100	1.5	2.6	7.5	1,000,000§	475 #	—	—	—	5750
Class A Amplifier ♣	250	—	3.0	1.0	—	58,000	1,200	70	—	—	5751
	100	—	1.0	0.8	—	58,000	1,200	70	—	—	5751
Class A Amplifier	120	120	2.0	5.2	3.5	—	$3,200 E_{c3} = 0$ volts		—	—	5784 ●
	120	120	2.0	3.6	4.8	—	$1,850 E_{c3} = -3.0$ volts		—	—	5784 ●
Half-Wave Rectifier	Max d-c output current = 0.1 ma; max peak current = 0.45 ma; max peak inverse voltage = 3,500 volts with supply impedance = 1 meg min.										5785 ●
Class A Amplifier	26.5	26.5	0	2.8	0.9	70,000§	3,450	—	—	—	5797 ●
Class A Amplifier ♣	26.5	—	0	2.0	—	7,100§	3,400	24	—	—	5798 ●
Class A Amplifier ♣	250	—	8.5	10.5	—	7,700§	2,200	17.	—	—	5814
	100	—	0	11.8	—	6,250§	3,100	19.5	—	—	5814-A
Class A Amplifier	135	135	22	61†	2.5†	15,000§	5,000	—	1,700	4.3	5824
Half-Wave Rectifier	Max d-c output current □ = 2 ma; max peak inverse voltage □ = 60,000 volts, rms supply voltage = 21,200 volts; max peak current □ = 40 ma										5825
Half-Wave Rectifier	Max d-c output current per plate = 5 ma; max peak inverse voltage = 330 volts; rms supply voltage per plate = 117 volts; max peak current per plate = 30 ma										5829 ●



5744



5785



5829

□ Absolute maximum rating.

§ Approximate.

♣ Per section.

♠ Maximum.

♣ Grids 2 and 4 are screen. Grid 3 is signal input grid.

# Conversion transconductance.

▲ Without external shield.

1—Section 1.

2—Section 2.

† Zero signal.

◆ Design maximum rating.



Service	Plate Volts	Screen Volts	Neg Grid Volts	Plate Milli-am-peres	Screen Milli-am-peres	R <sub>p</sub> ' Ohms	G <sub>m</sub> ' μmhos	μ Fac-tor	Load for Rated Out-put, Ohms	Power Out-put, Watts	Tube Type
Full-Wave Rectifier	Max d-c output current = 65 ma; max peak inverse voltage = 1,375 volts; rms supply voltage per plate = 300 volts; max peak current per plate = 270 ma										5838
Full-Wave Rectifier	Max d-c output current = 65 ma; max peak inverse voltage = 1,375 volts; rms supply voltage per plate = 300 volts; max peak current per plate = 270 ma										5839
Class A Amplifier	100	100	R <sub>k</sub> = 150	7.5	2.4	260,000	5,000	—	—	—	5840 ⊙
Class A Amplifier	150	—	R <sub>k</sub> = 62	26	—	1,800	24,000	43	—	—	5842
Class A Amplifier { Frequency Halfer {	100	—	R <sub>k</sub> = 470	4.8	—	7,550§	3,700	28	—	—	5844
	150 ‡ 150 ‡	—	0 10	4.8* 0.1 †	—	R <sub>g1</sub> = 47,000 ohms R <sub>g1</sub> = 47,000 ohms	—	—	20,000 20,000	—	
Class A Amplifier	150	150	R <sub>k</sub> = 110	13	4.5	—	12,500	—	—	—	5847
Class A Amplifier	125	125	7.5	5.5	0.9	175,000	1,600	—	—	—	5851 ⊙
Full-Wave Rectifier	Max d-c output current = 65 ma; max peak inverse voltage = 1,375 volts; rms supply voltage per plate = 300 volts; max peak current per plate = 270 ma										5852
Class A Amplifier	45	45	2.0	0.8	0.25	350,000	550	—	50,000	0.0095	5854 ⊙
Class A Amplifier	315	225	13	34	2.2	77,000	3,750	—	8,500	5.5	5871
Class A Amplifier †	150	—	3.0	9.0	—	—	2,900	22	—	—	5873 ⊙
Class A Amplifier	90	90	0	3.5	1.0	—	2,500	—	—	—	5875 ⊙
Class A Amplifier	250	—	R <sub>k</sub> = 75	18	—	8,625	6,500	56	—	—	5876
Class A Amplifier Class A Amplifier	250	100	3.0	1.8	0.4	2,000,000	1,000	—	—	—	5879
	250	—	8.0	5.5	—	13,700	1,530	21	—	—	
Class A Amplifier Class AB <sub>1</sub> Amplifier	350	250	18	53 ‡	2.5 ‡	48,000	5,200	—	4,200	11.3	5881
	250	250	14	75 ‡	4.3 ‡	30,000	6,100	—	2,500	6.7	
	360	270	22.5	88 ‡	5.0 ‡	—	—	—	3,800	18	
	360	270	22.5	88 ‡	5.0 ‡	—	—	—	6,600	26.5	
Shunt Regulator	30,000	200	60	0	0	—	Peak G <sub>1</sub> signal = 0 volts				5890
	30,000	200	60	0.06	0	—	Peak G <sub>1</sub> signal = 20 volts				
	30,000	200	60	0.50	0	—	Peak G <sub>1</sub> signal = 45 volts				
Full-Wave Rectifier	Max d-c output current per plate ⊕ = 10 ma; max peak inverse voltage ⊕ = 460 volts; rms supply voltage per plate = 150 volts; max peak current per plate ⊕ = 60 ma										5896 ⊙
Class A Amplifier RF Oscillator	100	—	R <sub>k</sub> = 150	8.5	—	—	5,800	27	—	—	5897 ⊙
	150	—	—	20	—	Frequency = 500 mc				0.9	
Class A Amplifier	150	—	R <sub>k</sub> = 680	1.7	—	—	2,700	70	—	—	5898 ⊙

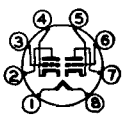

5073

- § Approximate.
- ▲ Without external shield.
- ‡ Zero signal.
- ◆ Grids 3 and 5 are screen. Grid 4 is signal-input grid.
- # Conversion transconductance.
- ♣ Maximum.
- ▼ Grids 2 and 4 are screen. Grid 3 is signal-input grid.
- ⊗ Screen supply voltage.
- ⊕ Absolute maximum rating.
- ‡ Plate-to-plate.
- † Per section.
- ⊕ Design maximum rating.
- ⊗ For both sections.
- \* Minimum.
- ‡ Heater warm-up time controlled for series-string service.
- § Plate supply voltage.
- || Input plate.
- ‡—The duration of the pulse voltage must not exceed 15 percent of one scanning cycle.
- 1—Section 1.
- 2—Section 2.
- †—A resistor of 3 ohms must be put in series with heater.

Tube Type	Classification by Construction	Base Connections	Out-line Dwg	Fila-ment Volts	Fila-ment Amp	Max Plate Watts	Max Plate Volts	Max Screen Volts	Capacitance in Micromicrofarads		
									Input	Out-put	Grid-plate
5899 ●	Semi-Remote-Cutoff RF Pentode	8DL	3-1	6.3	0.15	0.85	165	155	4.2	3.4	0.015
5900 ●	Semi-Remote-Cutoff RF Pentode	8DL	3-1	6.3	0.15	1.1	165	155	4.4	3.4	0.015
5901 ●	Sharp-Cutoff RF Pentode	8DL	3-1	6.3	0.15	1.1	165	155	4.2	3.4	0.015
5902 ●	Beam Power Amplifier	8DL	3-3	6.3	0.45	4.1	165	155	6.5	7.5	0.11
5903 ●	High-Frequency Twin Diode	8DJ	3-1	26.5	0.075	—	Tube Voltage Drop: 4.5 v at 18 ma d-c				
5904 ●	Medium-Mu Triode	8DK	3-1	26.5	0.045	—	55	—	2.4	2.2	1.8
5905 ●	Sharp-Cutoff RF Pentode	8DL	3-1	26.5	0.045	—	55	55	4.4	3.4	0.015
5906 ●	Sharp-Cutoff RF Pentode	8DL	3-1	26.5	0.045	1.1	165	155	4.2	3.4	0.015
5907 ●	Remote-Cutoff RF Pentode	8DL	3-1	26.5	0.045	—	55	55	4.0	3.4	0.015
5908 ●	Dual-Control RF Pentode	8DC	3-1	26.5	0.045	—	55	55	Ec <sub>3</sub> = 0 volts		
5910	Sharp-Cutoff Pentode	6AR	5-2	1.4 DC	0.05	—	90	90	3.6	7.5	0.008
5915 5915-A	Pentagrid Amplifier	7CH	5-2	6.3	0.3	1.0	250	125	Ec <sub>3</sub> = 0.0 volts Ec <sub>2</sub> = -10 volts Ec <sub>1</sub> = 0.0 volts		
5916 ●	Dual-Control Pentode	8DC	3-1	26.5	0.045	1.1	165	155	G <sub>3</sub> tied to cathode Ec <sub>2</sub> = -1 volt		
5980	Medium-Mu Twin Triode	7BF	5-3	6.3	0.4	1.5	150	—	—	—	—
5930	Low-Mu Power-Amplifier Triode (Special 2A3)	4D	T-X	2.5	2.5	15	360	—	—	—	—
5931	Full-Wave High-Vacuum Rectifier (Special 5U4-G)	5T	T-X	5.0	3.0	—	Tube Voltage Drop: 58 volts at 225 ma d-c				
5932	Beam Power Amplifier (Special 6L6-G)	7AC	T-X	6.3	0.9	21	400	300	—	—	—

Metal tubes are shown in bold-face type, miniature tubes in *italics*.

● Subminiature type.

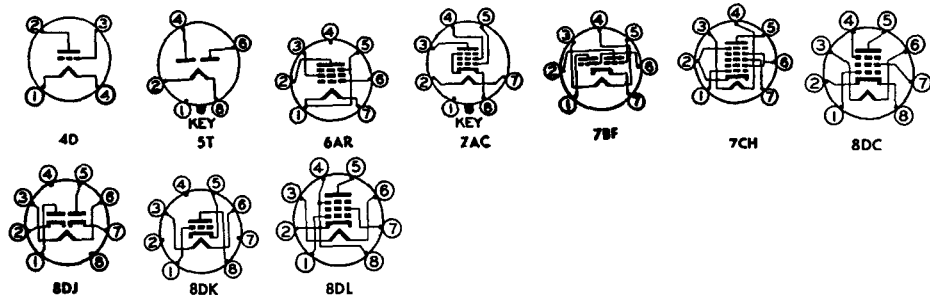

Service	Plate Volts	Screen Volts	Neg Grid Volts	Plate Milli-amperes	Screen Milli-amperes	$R_p'$ Ohms	$G_m'$ $\mu$ mhos	$\mu$ Factor	Load for Rated Output, Ohms	Power Output, Watts	Tube Type
Class A Amplifier	100	100	$R_k = 120$	7.2	2.0	260,000 $\S$	4,500	—	—	—	5899 $\bullet$
Class A Amplifier	100	100	$R_k = 120$	7.2	2.2	260,000	4,500	—	—	—	5900 $\bullet$
Class A Amplifier	100	100	$R_k = 150$	7.5	2.4	230,000	5,000	—	—	—	5901 $\bullet$
Class A Amplifier	110	110	$R_k = 270$	30	2.2	15,000 $\S$	4,200	—	3,000	1.0	5902 $\bullet$
Full-Wave Rectifier	Max d-c output current per plate $\square = 10$ ma; max peak inverse voltage $\square = 460$ volts; rms supply voltage per plate = 150 volts; max peak current per plate $\square = 60$ ma										5903 $\bullet$
Class A Amplifier	26.5	—	$R_g = 2.2$ meg	2.75	—	4,250 $\S$	4,700	20	—	—	5904 $\bullet$
Class A Amplifier	26.5	26.5	$R_g = 2.2$ meg	2.3	0.9	110,000	2,850	—	—	—	5905 $\bullet$
Class A Amplifier	100	100	$R_k = 150$	7.5	2.4	260,000	5,000	—	—	—	5906 $\bullet$
Amplifier Class A	26.5	26.5	$R_g = 2.2$ meg	2.7	1.1	100,000	3,000	—	—	—	5907 $\bullet$
Class A Amplifier	26.5	26.5	$R_g = 2.2$ meg	3.3	2.0	31,000 $\S$	2,200	—	—	—	5908 $\bullet$
Class A Amplifier	90	90	0	1.6	0.45	1,500,000	900 $\S$	—	—	—	5910
Gated Amplifier	150 $\S$	75	10	0	0	$R_{g1} = R_{g3} = 47,000$	—	20,000	—	—	5915
	150 $\S$	69 $\S$	0	0	14	$R_{g1} = R_{g3} = 47,000$	—	20,000	—	—	5915-A
	150 $\S$	71 $\S$	0	5.8	9.0	$R_{g1} = R_{g3} = 47,000$	—	20,000	—	—	
Class A Amplifier	100	100	$R_k = 150$	5.6	4.0	110,000 $\S$	3,200	—	—	—	5916 $\bullet$
	100	100	$R_k = 150$	4.0	5.8	50,000 $\S$	1,950	—	—	—	
Class A Amplifier $\clubsuit$	100	—	1.8	8.5	—	5,500	25	—	—	—	5920
Frequency Halfer $\clubsuit$	150 $\S$	—	0	4.5*	—	$R_{g1} = 47,000$ ohms	—	20,000	—	—	
	150 $\S$	—	10	0.2 $\clubsuit$	—	$R_{g1} = 47,000$ ohms	—	20,000	—	—	
Class A Amplifier	250	—	45	60 $\dagger$	—	800	5,250	4.2	2,500	3.5	5930
Full-Wave Rectifier	Max d-c output current $\square = 250$ ma; max peak inverse voltage $\square = 1,700$ volts; max rms supply voltage per plate $\square = 500$ volts; max peak current per plate $\square = 750$ ma										5931
Class A Amplifier	250	250	14	72 $\dagger$	5.0 $\dagger$	22,500	6,000	—	2,500	6.5	5932

$\S$  Approximate.

$\blacktriangle$  Without external shield.

$\dagger$  Zero signal.

$\blacklozenge$  Grids 3 and 5 are screen. Grid 4 is signal-input grid.

$\#$  Conversion transconductance.

$\#$  Maximum.

$\blacklozenge$  Grids 2 and 4 are screen. Grid 3 is signal-input grid.

$\blacklozenge$  Screen supply voltage.

$\square$  Absolute maximum rating.

$\dagger$  Plate-to-plate.

$\clubsuit$  Per section.

$\blacklozenge$  Design maximum rating.

$\oplus$  For both sections.

\* Minimum.

$\blacklozenge$  Heater warm-up time controlled for series-string service.

$\S$  Plate supply voltage.

$\blacklozenge$  Input plate.

$\blacklozenge$  The duration of the pulse voltage must not exceed 15 percent of one scanning cycle.

1—Section 1.

2—Section 2.

$\blacklozenge$  A resistor of 3 ohms must be put in series with heater.

Tube Type	Classification by Construction	Base Connections	Out-line Dwg	Fila-ment Volts	Fila-ment Amp	Max Plate Watts	Max Plate Volts	Max Screen Volts	Capacitance in Micromicrofarads		
									Input	Out-put	Grid-plate
<b>5961</b>	Pentagrid Converter (Special 6SA7)	8R ♠	8-1	6.3	0.3	1.0	300	100	Osc $I_{g1} = 0.5$ ma $R_{g1} = 20,000$ ohms		
<i>5963</i>	Medium-Mu Twin Triode	9A	6-2	{12.6 6.3}	{0.15 0.3}	2.5 ♣ □	250 □	—	1.9 ▲	0.5 <sub>1</sub> ▲ 0.35 <sub>2</sub> ▲	1.5 ▲
<i>5964</i>	High-Mu Twin Triode	7BF	5-2	6.3	0.45	1.5 ♣ □	250 □	—	2.1 ▲	0.4 ▲	1.3 ▲
<i>5965</i>	Twin Triode	9A	6-2	{12.6 6.3}	{0.225 0.45}	2.4 ♣ □ 4.4 ⊕ □	300	—	3.8 ▲	0.5 <sub>1</sub> ▲ 0.38 <sub>2</sub> ▲	3.0 ▲
5967 ●	Medium-mu Twin Triode	8DQ	3-8	1.25	0.12	—	50 □	—	0.9 ▲	0.9 ▲	1.7 ▲
5971 ●	Medium-Mu Triode	5971	2-1	1.25 DC	0.08	0.7	135	—	1.6 ▲	1.7 ▲	2.3 ▲
5975 ●	Medium-Mu Triode	5975	3-6	6.3	0.175	3.0	250	—	—	—	—
5977 ●	Medium-Mu Triode	8DK	3-1	6.3	0.15	1.2 ◆	180 ◆	—	2.0	2.2	1.3
5987 ●	Low-Mu Triode	8DM	3-4	6.3	0.45	4.0 □	165 □	—	3.2	5.0	3.2
5992	Beam Power Amplifier (Special 6V6-GT)	7AC	9-9	6.3	0.6	10	300	275	—	—	—
<i>5993</i>	Full-Wave High-Vacuum Rectifier	5993	6-3	6.3	0.8	—	—	—	—	—	—
5995 ●	Half-Wave High-Vacuum Rectifier	5995	T-X	6.3	0.3	—	Tube Voltage Drop: 25 volts at 100 ma d-c			—	—
5998	Low-Mu Twin Triode	8BD	16-3	6.3	2.4	13 ♣	250	—	—	—	—
6004	Full-Wave High-Vacuum Rectifier	2AJ	T-X	5.0	2.0	—	Tube Voltage Drop: ♣ 60 volts at 145 ma d-c			—	—
<i>6005</i>	Beam Power Amplifier	7BZ	5-3	6.3	0.45	11 ◆	275 ◆	275 ◆	Single Tube 2 Tubes, Push-pull		
<b>6006</b>	Semi-Remote-Cutoff RF Pentode (Special 6SG7)	8BK	8-1	6.3	0.3	3.0	300	200	8.5	7.0	0.004 ♣
6007 ●	Power Amplifier Pentode	512-AX	T-X	1.25 DC	0.0133	0.025	45	45	2.5 ▲	2.2 ▲	0.2 ♣ ▲
6008 ●	Sharp-Cutoff Pentode	512-AX	T-X	0.625 DC	0.0133	0.0015	45	45	1.5 ▲	1.5 ▲	0.2 ♣ ▲
6021 ●	Medium-Mu Twin Triode	8DG	3-1	6.3	0.3	0.8 ♣ ◆	165 ◆	—	2.4 ▲	0.28 <sub>1</sub> ▲ 0.32 <sub>2</sub> ▲	1.5 ▲

Metal tubes are shown in bold-face type, miniature tubes in *italics*. ● Subminiature type.

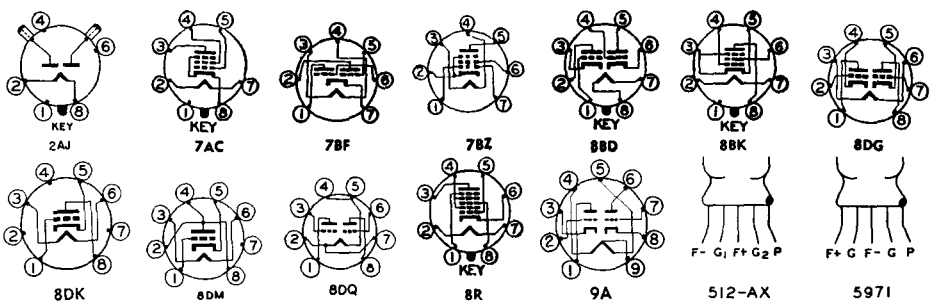

Service	Plate Volts	Screen Volts	Neg Grid Volts	Plate Milli-am-peres	Screen Milli-am-peres	$R_p$ , Ohms	$G_{m1}$ , $\mu$ mhos	$\mu$ Fac-tor	Load for Rated Out-put, Ohms	Power Out-put, Watts	Tube Type
Converter	250	100	2.0	3.5	8.5	1,000,000§	450 #	—	—	—	5961
Class A Amplifier $\blacklozenge$ Frequency Halfer $\blacklozenge$	67.5	—	0	8.5	—	6,600	3,200	21	—	—	5963
	150§ 150§	— —	15 0	0 5.1	— —	$R_{k1} = 47,000$ $R_{g1} = 47,000$	—	—	20,000 20,000	— —	
Class A Amplifier $\blacklozenge$ Frequency Halfer $\blacklozenge$	100	—	$R_k = 50 \oplus$	9.5	—	6,500	6,000	39	—	—	5964
	150§ 150§	— —	10 0	0 5.0	— —	$R_{g1} = 47,000$ $R_{g1} = 47,000$	—	—	20,000 20,000	— —	
Class A Amplifier $\blacklozenge$ Frequency Halfer $\blacklozenge$	150	—	$R_k = 220$	8.5	—	7,000§	6,700	47	—	—	5965
	150§ 150§	— —	— 5.5	10.5§ 0.15	— —	—	$I_c = 140 \mu$ amp	—	7,200 7,200	— —	
Class A Amplifier $\blacklozenge$	45	—	$E_{cc} = 0$	3.0	—	8,500	2,000	17	$R_g = 5.0$ meg	—	5967 ●
Class A Amplifier	135	—	2.5	4.0	—	—	2,150	23	—	—	5971 ●
Class A Amplifier	200	—	$R_k = 680$	12	—	4,000	4,000	16	—	—	5975 ●
Class A Amplifier	100	—	$R_k = 270$	10	—	—	4,500	16	—	—	5977 ●
Class A Amplifier	100	—	18	9.0	—	—	1,850	4.1	—	—	5987 ●
Class A Amplifier	250	250	12.5	45†	4.5†	45,000	4,000	—	5,000	4.0	5992
Full-Wave Rectifier	Max d-c output current = 60 ma; max peak inverse voltage = 1,250 volts; rms supply voltage per plate = 260 volts; max peak current per plate = 230 ma										5993
Half-Wave Rectifier	Max d-c output current = 45 ma; max peak inverse voltage = 850 volts; max rms supply voltage = 300 volts; max peak current = 275 ma										5995 ●
Class A Amplifier $\blacklozenge$	110	—	$R_k = 105$	100	—	350	15,500	5.4	—	—	5998
Full-Wave Rectifier	Max d-c output current = 120 ma; max peak inverse voltage = 1400 volts; rms supply voltage per plate = 375 volts; max peak current per plate = 375 ma										6004
Class A Amplifier $\blacklozenge$ Class AB1 Amplifier	250	250	12.5	45†	4.5†	52,000§	4,100	—	5,000	4.5	6005
	180	180	8.5	29†	3.0†	58,000§	3,700	—	5,500	2.0	
	250	250	15	70†	5†	—	—	—	10,000	10	
Class A Amplifier	250	150	2.5	9.2	3.4	1,000,000*	4,000	—	—	—	6006
Class A Amplifier	22.5	22.5	0.2	0.475	0.1	400,000	420	—	—	—	6007 ●
Class A Amplifier	22.5	18	1.15	0.05	0.01	4,000,000	100	—	—	—	6008 ●
Class A Amplifier $\blacklozenge$	100	—	$R_k = 150$	6.5	—	6,500§	5,400	35	—	—	6021 ●



5975

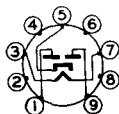

5993



5995

□ Absolute maximum rating.

▲ Without external shield.

1— Section 1.

2— Section 2.

◆ Per section.

§ Plate supply voltage.

§ Approximate.

† Zero signal.

‡ Plate-to-plate.

◆ Maximum.

\* Minimum.

◆ Design maximum rating.

# Conversion transconductance.

♥ Grids 2 and 4 are screen. Grid 3 is signal-

input grid.

⊕ For both sections.

Tube Type	Classification by Construction	Base Connections	Out-line Dwg	Fila-ment Volts	Fila-ment Amp	Max Plate Watts	Max Plate Volts	Max Screen Volts	Capacitance in Micromicrofarads		
									Input	Out-put	Grid-plate
<i>6028</i>	Sharp-Cutoff RF Pentode	7BD	5-1	20.0	0.05	1.7	180	140	4.0	2.8	0.02 ♣
<b>6029</b> Ⓞ	Medium-Mu Triode	5677	2-1	1.25 DC	0.2	1.0	135	—	1.3▲	1.4▲	1.6▲
<i>6042</i>	Medium-Mu Twin Triode	8BD	9-3	25.0	0.15	2.25 ♣	250	—	—	—	—
<i>6045</i>	Medium-Mu Twin Triode	7BF	5-2	6.3	0.35	1.6 ♣	330	—	2.0▲	0.451▲ 0.342▲	1.3▲
<i>6046</i>	Beam Power Amplifier (Special 25L6-GT)	7AC	9-11	25.0	0.3	10	200	125	—	—	—
<b>6049</b> Ⓞ	Semi-remote Cutoff RF Pentode	8DL	3-1	6.3	0.15	1.1	165	155	3.6	3.8	0.009 ♣
<b>6050</b> Ⓞ	High-Frequency Medium-Mu Triode	5677	2-1	1.25 DC	0.12	—	135	—	1.3	3.4	1.4
<i>6057</i>	High-Mu Twin Triode (Special 12AX7)	9A	6-2	{12.6 6.3}	{0.15 0.3}	1.0♣	300	—	1.6▲	0.461▲ 0.342▲	1.7▲
<i>6058</i>	Twin Diode (Special 6AL5)	6BT	5-2	6.3	0.3	—	—	—	—	—	—
<i>6059</i>	Sharp-Cutoff RF Pentode	9BC	6-2	6.3	0.15	1.75	300	125	4.25▲	4.0▲	0.01♣
<i>6060</i>	High-Frequency Twin Triode (Special 12AT7)	9A	6-2	{12.6 6.3}	{0.15 0.3}	2.5♣	350	—	2.25▲	0.4▲	1.6▲
<i>6061</i>	Beam Power Amplifier	9AM	6-3	6.3	0.45	12	315	285	—	—	—
<i>6063</i>	Full-Wave High-Vacuum Rectifier (Special 6X4)	5BS	5-3	6.3	0.6	—	—	—	—	—	—
<i>6064</i>	RF Pentode	7DB	5-2	6.3	0.3	2.5	250	250	7.8	3.9	0.01♣
<i>6065</i>	Remote-Cutoff RF Pentode	7DB	5-2	6.3	0.2	2.5	250	250	4.5	7.0	0.007 ♣
<i>6066</i>	Duplex-Diode High-Mu Triode (Special 6AT6)	7BT	5-2	6.3	0.3	—	300	—	—	—	—
<i>6067</i>	Medium-Mu Twin Triode (Special 12AU7)	9A	6-2	{12.6 6.3}	{0.15 0.3}	2.75 ♣	300	—	1.6▲	0.511▲ 0.352▲	1.5▲
<i>6072</i>	Twin Triode	9A	6-2	{12.6 6.3}	{0.175 0.35}	1.5 ♣	330	—	1.4▲	0.511▲ 0.382▲	1.5▲
<i>6080</i>	Low-Mu Twin Triode Power Amplifier (Special 6AS7-G)	8BD	T-X	6.3	2.5	13 ♣	250	—	6.0▲	2.2▲	8.0▲

Metal tubes are shown in bold-face type, miniature tubes in *italics*.

ⓄSubminiature type.

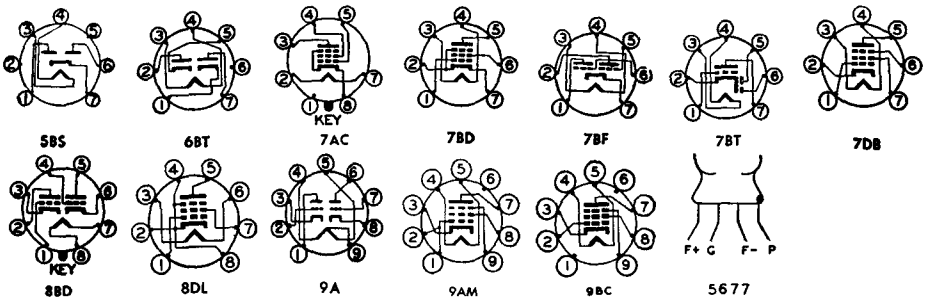



Service	Plate Volts	Screen Volts	Neg Grid Volts	Plate Milli-am-peres	Screen Milli-am-peres	R <sub>p</sub> , Ohms	G <sub>m</sub> , μmhos	μ Factor	Load for Rated Out-put, Ohms	Power Out-put, Watts	Tube Type
Class A Amplifier	120	120	R <sub>k</sub> = 180	7.5	2.5	300,000§	5,000	—	—	—	6028
Class A Amplifier	90	—	4.0	11	—	4,250§	2,000	8.5	—	—	6029 ●
Class A Amplifier ♦	250	—	9	6.5	—	9,100	2,200	20	—	—	6042
Class A Amplifier ♦	100	—	R <sub>k</sub> = 50 ⊕	9.0	—	5,900§	6,400	38	—	—	6045
Class A Amplifier	200	125	R <sub>k</sub> = 180	46†	2.2†	28,000§	8,000	—	4,000	3.8	6046
Relay Energizer	110 115‡ 115‡	110 115* 115*	7.5 0 25	49† 105 0.1§	4.0† 12.8 —	13,000§ R <sub>g</sub> <sup>1</sup> = 2 meg R <sub>g</sub> <sup>2</sup> = 1000 ohms	8,000	—	2,000 500 500	2.1 — —	—
Class A Amplifier	100	100	R <sub>k</sub> = 150	7.5	2.5	400,000§	3,550	—	—	—	6049 ●
Class A Amplifier	135	—	5	4.0	—	—	1,600	16	—	—	6050 ●
Class A Amplifier ♦	250	—	2	1.2	—	62,500	1,600	100	—	—	6057
Half-Wave Rectifier	Max d-c output current per plate = 9 ma; max peak inverse voltage = 420 volts; max rms supply voltage per plate = 150 volts; max peak current per plate = 54 ma										6058
Class A Amplifier	250	100	3	2.1	0.6	2,500,000	1,250	—	—	—	6059
Class A Amplifier ♦	250	—	2	10	—	10,000	5,500	55	—	—	6060
Class A Amplifier	250 315	250 225	12.5 13	45† 34†	4.5† 2.2†	52,000§ 77,000§	4,100 3,750	—	5,000 8,500	4.5 5.5	6061
Full-Wave Rectifier	Max d-c output current = 70 ma; max peak inverse voltage = 1250 volts; max rms supply voltage per plate = 325 volts; max peak current per plate = 210 ma										6063
Class A Amplifier	250	250	2.0	10	2.5	1,000,000	7,500	—	—	—	6064
Class A Amplifier	250	200	2.5	8.0	2.1	1,000,000	2,500	—	—	—	6065
Class A Amplifier	250	—	3.0	1.0	—	58,000	1,200	70	—	—	6066
Class A Amplifier ♦	250	—	8.5	10.5	—	7,700	2,200	17	—	—	6067
Class A Amplifier ♦	250	—	4.0	3.0	—	25,000§	1,750	44	—	—	6072
DC Amplifier ♦	135	—	R <sub>k</sub> = 250	125	—	280	7,000	2	—	—	6080

§ Approximate.  
 ▲ Without external shield.  
 † Zero signal.  
 ♦ Grids 3 and 5 are screen. Grid 4 is signal-input grid.  
 # Conversion transconductance.  
 ♣ Maximum.  
 ♥ Grids 2 and 4 are screen. Grid 3 is signal-input grid.  
 \* Screen supply voltage.  
 ⊕ Absolute maximum rating.  
 ‡ Plate-to-plate.  
 ♠ Per section.  
 ● Design maximum rating.

⊕ For both sections.  
 \* Minimum.  
 ¶ Heater warm-up time controlled for series-string service.  
 § Plate supply voltage.  
 || Input plate.  
 3—The duration of the pulse voltage must not exceed 15 percent of one scanning cycle.  
 1—Section 1.  
 2—Section 2.  
 4—A resistor of 3 ohms must be put in series with heater.

Tube Type	Classification by Construction	Base Connections	Out-line Dwg	Fila-ment Volts	Fila-ment Amp	Max Plate Watts	Max Plate Volts	Max Screen Volts	Capacitance in Micromicrofarads		
									Input	Out-put	Grid-plate
6082	Low-Mu Twin Triode Power Amplifier	8BD	T-X	26.5	0.6	13 $\blacklozenge$	250 $\square$	—	6.0 $\blacktriangle$	2.2 $\blacktriangle$	8.0 $\blacktriangle$
<i>6084</i>	AF Pentode	9BJ	6-3	6.3	0.3	1.0	300	200	5.1	7.1	0.025 $\clubsuit$
<i>6085</i>	Medium-Mu Twin Triode	9A	6-3	12.6 6.3	0.3 0.6	1.5 $\spadesuit$	300	—	2.8 <sub>1</sub> 2.7 <sub>2</sub>	1.2 <sub>1</sub> 1.3 <sub>2</sub>	2.6 <sub>1</sub> 2.7 <sub>2</sub>
<i>6086</i>	Pentode	9BK	6-3	18.0	0.1	2.1	210	210	8.8	3.6	0.015 $\clubsuit$
6087	Full-Wave High-Vacuum Rectifier	5L	9-41	5.0	2.0	—	Tube Voltage Drop: $\spadesuit$ 50 v at 125 ma d-c				
6088 $\bullet$	Power Amplifier Pentode	512-AX	2-1	1.25 DC	0.02	—	67.5 $\square$	67.5 $\square$	—	—	—
6092 $\bullet$	Power Amplifier Pentode	5672	2-1	1.25	0.05	—	67.5 $\square$	67.5 $\square$	—	—	—
<i>6094</i>	Beam Power Amplifier	9DH	T-X	6.3	0.6	12.5 $\square$	275 $\square$	275 $\square$	8.5 $\blacktriangle$	5.3 $\blacktriangle$	1.45 $\blacktriangle$
<i>6101</i>	Medium-Mu Twin Triode (Special 6J6)	7BF	5-2	6.3	0.45	0.85 $\spadesuit$	330 $\square$	—	2.0 $\blacktriangle$	0.4 $\blacktriangle$	1.5 $\blacktriangle$
6106	Full-Wave High-Vacuum Rectifier (Special 5Y3-GT)	5L	T-X	5.0	1.7	—	Tube Voltage Drop: $\spadesuit$ 60 v at 125 ma d-c				
6110 $\bullet$	Twin Diode	8DJ	3-1	6.3	0.15	—	Tube Voltage Drop: $\spadesuit$ 10 v at 15 ma d-c				
6111 $\bullet$	Medium-Mu Twin Triode	8DG	3-1	6.3	0.3	1.0 $\spadesuit$	165 $\diamond$	—	2.1	1.3 <sub>1</sub> 1.4 <sub>2</sub>	1.4
6112 $\bullet$	High-Mu Twin Triode	8DG	3-1	6.3	0.3	0.3 $\spadesuit$	165 $\diamond$	—	1.9	1.5	1.0
6113	High-Mu Twin Triode (Special 6SL7-GT)	8BD	9-11	6.3	0.3	1.0 $\spadesuit$	250	—	3.0	3.8	2.8
<b>6118</b>	Duplex-Diode High-mu Triode (Special 6Q7)	7V	8-4	6.3	0.3	—	300	—	5.0	3.8	1.4
6121 $\bullet$	Medium-mu Triode	5677	2-1	1.25	0.12	1.1 $\square$	185 $\square$	—	1.4 $\blacktriangle$	1.9 $\blacktriangle$	1.4 $\blacktriangle$
<i>6132</i>	RF Pentode (Special 6CH6)	9BA	6-3	6.3	0.75	12	275	275	14 $\blacktriangle$	5.0 $\blacktriangle$	0.25 $\clubsuit$
<b>6134</b>	Sharp-Cutoff RF Pentode	8N	8-1	6.3	0.45	3.0 $\diamond$	330 $\diamond$	165 $\diamond$	11	5.0	0.015 $\clubsuit$
<i>6135</i>	Medium-Mu Triode	6BG	5-2	6.3	0.175	3.4 $\diamond$	330 $\diamond$	—	1.5 $\blacktriangle$	0.7 $\blacktriangle$	1.4 $\blacktriangle$

Metal tubes are shown in bold-face type, miniature tubes in italics.  $\bullet$  Subminiature type.

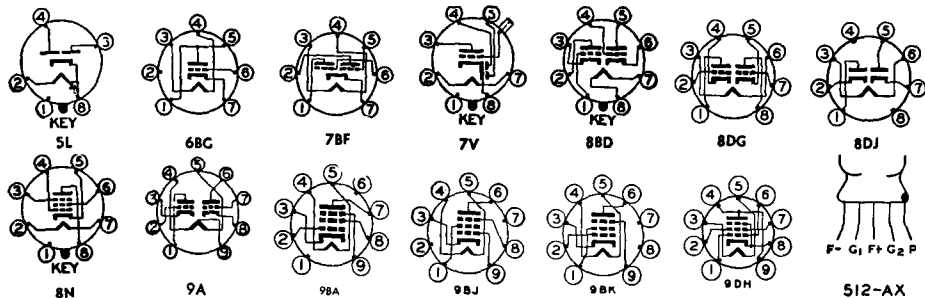

Service	Plate Volts	Screen Volts	Neg Grid Volts	Plate Milli-amperes	Screen Milli-amperes	R <sub>p</sub> ' Ohms	G <sub>m</sub> ' μmhos	μ Factor	Load for Rated Output, Ohms	Power Output, Watts	Tube Type
DC Amplifier ♠	135	—	R <sub>k</sub> = 250	125	—	280	7,000	2	—	—	6082
Class A Amplifier	250	100	2.0	3.0	0.55	1,800,000	1,850	—	—	—	6084
Class A Amplifier ♠	250	—	5.5	6	—	—	2,700	30	—	—	6085
Class A Amplifier	210	120	R <sub>k</sub> = 165	10	2.1	500,000	9,000	—	—	—	6086
Full-Wave Rectifier	Max d-c output current = 125 ma; max peak inverse voltage = 1400 volts; rms supply voltage per plate = 350 volts; max peak current per plate = 375 ma										6087
Class A Amplifier	45	45	1.25	0.65†	0.15†	700,000§	625	—	80,000	0.0105	6088 ●
Class A Amplifier	45	45	4.5	1.4	0.4	—	600	—	30,000	0.025	6092 ●
Class A Amplifier	250	250	12.5	45	3.5	32,000*	4,100	—	—	4.5	6094
Class A Amplifier ♠	100	—	R <sub>k</sub> = 50 ⊕	8.5	—	6,300	6,000	38	—	—	6101
Full-Wave Rectifier	Max d-c output current = 125 ma; max peak inverse voltage = 1,550 volts; rms supply voltage per plate = 350 volts; max peak current per plate = 415 ma										6106
Full-Wave Rectifier	Max d-c output current per plate □ = 4.4 ma; max peak inverse voltage □ = 460 volts; max rms supply voltage per plate □ = 165 volts; max peak current per plate □ = 26.5 ma										6110 ●
Class A Amplifier ♠	100	—	R <sub>k</sub> = 220	8.5	—	4,000§	5,000	20	—	—	6111 ●
Class A Amplifier ♠	150	—	R <sub>k</sub> = 820	1.75	—	28,000§	2,500	70	—	—	6112 ●
	100	—	R <sub>k</sub> = 1,500	0.8	—	39,000§	1,800	70	—	—	
Class A Amplifier ♠	250	—	2.0	2.3	—	44,000	1,600	70	—	—	6113
Class A Amplifier	250	—	3.0	1.0	—	58,000§	1,200	70	—	—	6118
	100	—	1.0	0.8	—	58,000§	1,200	70	—	—	
Class A Amplifier	135	—	5.0	4.0	—	9,400§	1,600	15	—	—	6121 ●
Class A Amplifier	250	250	4.5	40	6.0	50,000	11,000	—	—	—	6132
Class A Amplifier	300	150	R <sub>k</sub> = 160	10	2.5	1,000,000§	9,000	—	—	—	6134
Class A Amplifier	250	—	8.5	10.5	—	7,700§	2,200	17	—	—	6135
	100	—	0	11.8	—	6,250§	3,100	19.5	—	—	

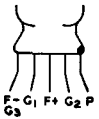

5672



5677

- § Approximate.
- ▲ Without external shield.
- † Zero signal.
- ◆ Grids 3 and 5 are screen. Grid 4 is signal-input grid.
- # Conversion transconductance.
- ♣ Maximum.
- ♠ Grids 2 and 4 are screen. Grid 3 is signal-input grid.
- ✱ Screen supply voltage.
- ⊕ Absolute maximum rating.
- ‡ Plate-to-plate.
- ♣ Per section.
- ⊕ Design maximum rating.

- ⊕ For both sections.
- \* Minimum.
- ¶ Heater warm-up time controlled for series-string service.
- § Plate supply voltage.
- || Input plate.
- ① The duration of the pulse voltage must not exceed 15 percent of one scanning cycle.
- 1—Section 1.
- 2—Section 2.
- ← A resistor of 3 ohms must be put in series with heater.

Tube Type	Classification by Construction	Base Connections	Out-line Dwg	Fila-ment Volts	Fila-ment Amp	Max Plate Watts	Max Plate Volts	Max Screen Volts	Capacitance in Micromicrofarads		
									Input	Out-put	Grid-plate
<i>6136</i>	Sharp-Cutoff RF Pentode	7BK	5-2	6.3	0.3	3.1 $\blacklozenge$	330 $\blacklozenge$	165 $\blacklozenge$	6.0 $\blacktriangle$	5.0 $\blacktriangle$	0.0035 $\blackclubsuit$
<b>6137</b>	Remote-Cutoff RF Pentode	8N	8-1	6.3	0.3	3.0 $\blacklozenge$	330 $\blacklozenge$	140 $\blacklozenge$	5.0	7.0	0.003 $\blackclubsuit$
6145	Sharp-Cutoff Pentode	8V	9-31	6.3	0.6	10	300	150	14	7.5	0.06 $\blackclubsuit$
6152 $\odot$	Low-mu Triode	5975	3-6	6.3	0.2	1.1 $\square$	180 $\square$	—	2.9 $\blacktriangle$	1.28 $\blacktriangle$	1.32 $\blacktriangle$
<i>6157</i>	Half-Wave High-Vacuum Rectifier	9BW	6-7	6.3	0.8	—	—	—	—	—	—
<i>6158</i>	Medium-Mu Twin Triode	9A	6-2	$\left\{ \begin{matrix} 12.6 \\ 6.3 \end{matrix} \right.$	$\left\{ \begin{matrix} 0.3 \\ 0.6 \end{matrix} \right.$	5.0 $\blackclubsuit$	300	—	2.3 $\blacktriangle$	$\left\{ \begin{matrix} 0.95_1 \\ 0.85_2 \end{matrix} \right.$ $\blacktriangle$	2.1 $\blacktriangle$
6169 $\odot$	High-Frequency Triode	8EE	3-1	6.3	0.15	3.0	250	—	2.5	2.6	1.6
6173	UHF Diode (Pencil)	6173	T-X	6.3	0.135	—	—	—	—	—	—
6180	Medium-Mu Twin Triode (Special 6SN7-GT)	8BD	9-3	6.3	0.6	2.25 $\blackclubsuit$	300	—	2.3 <sub>1</sub> $\blacktriangle$ 2.6 <sub>2</sub> $\blacktriangle$	2.5 <sub>1</sub> $\blacktriangle$ 2.7 <sub>2</sub> $\blacktriangle$	3.5 <sub>1</sub> $\blacktriangle$ 3.3 <sub>2</sub> $\blacktriangle$
6184 $\odot$	UHF Twin Diode	8EH	T-X	6.3	0.15	—	Tube Voltage Drop: $\blackclubsuit$ 5.0 v at 8.0 ma				
6193 $\odot$	High-Frequency Twin Triode	8DG	3-3	6.3	0.3	2.0 $\blackclubsuit$	250	—	2.75	2.20	1.46
6195 $\odot$	Beam Power Amplifier	6CL	T-X	$\left\{ \begin{matrix} 1.25 \\ 2.5 \\ DC \end{matrix} \right.$	$\left\{ \begin{matrix} 0.22 \\ 0.11 \end{matrix} \right.$	2.5	180	150	2.4	1.3	0.045
<i>6197</i>	Sharp-Cutoff Power Amplifier Pentode	9BV	6-3	6.3	0.65	7.5 $\square$	300 $\square$	250 $\square$	—	—	—
<i>6201</i>	High-Frequency Twin Triode	9A	6-2	$\left\{ \begin{matrix} 12.6 \\ 6.3 \end{matrix} \right.$	$\left\{ \begin{matrix} 0.15 \\ 0.3 \end{matrix} \right.$	2.5 $\blackclubsuit$ $\blacklozenge$	330 $\blacklozenge$	—	2.5 $\blacktriangle$	$\left\{ \begin{matrix} 0.45_1 \\ 0.38_2 \end{matrix} \right.$ $\blacktriangle$	1.6 $\blacktriangle$
<i>6202</i>	Full-Wave High-Vacuum Rectifier	5BS	5-3	6.3	0.6	—	Tube Voltage Drop: $\blackclubsuit$ 22 v at 50 ma d-c				
<i>6203</i>	Full-Wave High-Vacuum Rectifier	9CD	6-3	6.3	0.9	—	Tube Voltage Drop: $\blackclubsuit$ 22 v at 70 ma d-c				
6205 $\odot$	Sharp-Cutoff RF Pentode	8DC	3-1	6.3	0.15	0.9 $\blacklozenge$	165 $\blacklozenge$	155 $\blacklozenge$	4.2	3.4	0.015 $\blackclubsuit$
6206 $\odot$	Semi-Remote-Cutoff RF Pentode	8DC	3-1	6.3	0.15	0.85 $\blacklozenge$	165 $\blacklozenge$	155 $\blacklozenge$	4.2	3.4	0.015 $\blackclubsuit$
<i>6211</i>	Medium-Mu Twin Triode	9A	6-2	$\left\{ \begin{matrix} 12.6 \\ 6.3 \end{matrix} \right.$	$\left\{ \begin{matrix} 0.15 \\ 0.3 \end{matrix} \right.$	1.5 $\blackclubsuit$ $\square$	200 $\square$	—	2.9 $\blacktriangle$	$\left\{ \begin{matrix} 0.54_1 \\ 0.46_2 \end{matrix} \right.$ $\blacktriangle$	2.22 $\blacktriangle$

Metal tubes are shown in bold-face type, miniature tubes in *italics*.

$\odot$ Subminiature type.

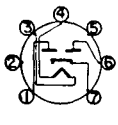

5BS



6CL

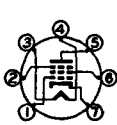

7BK

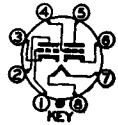

8BD

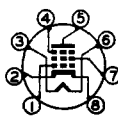

8DC

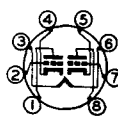

8DG

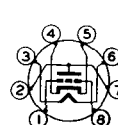

8EE

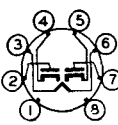

8EH

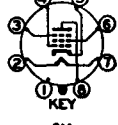

8N

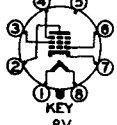

8V

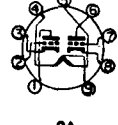

9A

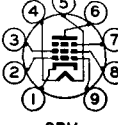

9BV



9BW



9CD

Service	Plate Volts	Screen Volts	Neg Grid Volts	Plate Milli-amperes	Screen Milli-amperes	R <sub>p</sub> , Ohms	G <sub>m</sub> , μmhos	μ Factor	Load for Rated Output, Ohms	Power Output, Watts	Tube Type
Class A Amplifier	250	150	R <sub>k</sub> = 68	10.6	4.3	1,000,000§	5,200	—	—	—	6136
	100	100	R <sub>k</sub> = 150	5.0	2.1	500,000§	3,900	—	—	—	
Class A Amplifier	250	100	3	9.2	2.6	800,000§	2,000	—	—	—	6137
	100	100	1	13	4.0	120,000§	2,350	—	—	—	
Pulse Amplifier	150	100	0	34	8	100,000	—	—	—	—	6145
	150	100	5.3	2.0♣	—	—	—	—	—	—	
	60	100	0	—	12♣	—	—	—	—	—	
Class A Amplifier	100	—	R <sub>k</sub> = 270	10	—	3,400§	5,100	17.5	—	—	6152⊙
Half-Wave Rectifier	Max d-c output current = 125 ma; max peak inverse voltage = 1000 volts; rms supply voltage = 350 volts; max peak current = 450 ma										6157
Class A Amplifier ♠	250	—	4.6	6.0	—	14,000	2,300	32	—	—	6158
Class A Amplifier	180	—	1.0	11.5	—	8,500	6,500	55	—	—	6169⊙
Half-Wave Rectifier	Max d-c output current ⊠ = 5.5 ma; max peak inverse voltage ⊠ = 375 volts; max peak current ⊠ = 50 ma										6173
Class A Amplifier ♠	250	—	9.0	6.5	—	9,100	2,200	20	—	—	6180
	100	—	0	10.6	—	8,000	2,500	20	—	—	
Full-Wave Rectifier	Max d-c output current = 20 ma; max peak inverse voltage = 450 volts; max rms supply voltage per plate = 200 volts; max peak current per plate = 50 ma										6184⊙
Class A Amplifier ♠	180	—	1.0	11.5	—	8,500	6,500	55	—	—	6193⊙
	90	—	0.50	4.5	—	9,000	5,800	50	—	—	
Class A Amplifier	125	125	7.5	9.0	1.5	120,000	2,100	—	—	—	6195⊙
Class A Amplifier	250	150	3.0	30	7.0	90,000	11,000	—	—	—	6197
Class A Amplifier ♠	250	—	R <sub>k</sub> = 200	10	—	10,900§	5,500	60	—	—	6201
	100	—	R <sub>k</sub> = 270	3.3	—	14,300§	4,000	57	—	—	
Full-Wave Rectifier	Max d-c output current ⊠ = 55 ma; max peak inverse voltage ⊠ = 1375 volts; rms supply voltage per plate = 325 volts; max peak current per plate ⊠ = 220 ma										6202
Full-Wave Rectifier	Max d-c output current ⊠ = 77 ma; max peak inverse voltage ⊠ = 1375 volts; rms supply voltage per plate = 325 volts; max peak current per plate ⊠ = 300 ma										6203
Class A Amplifier	100	100	R <sub>k</sub> = 150	7.5	2.4	260,000	5,000	—	—	—	6205⊙
Class A Amplifier	100	100	R <sub>k</sub> = 120	7.2	2.2	260,000	4,500	—	—	—	6206⊙
Class A Amplifier ♠	100	—	R <sub>k</sub> = 470	4.6	—	7,500	3,600	27	—	—	6211
	150‡	—	0	4.8*	—	R <sub>g1</sub> = 47,000 ohms	—	—	20,000	—	
	150‡	—	10♣	0.1	—	R <sub>g1</sub> = 47,000 ohms	—	—	20,000	—	



5975



6173

- ♠ Per section.  
 ⊠ Absolute maximum rating.  
 ▲ Without external shield.  
 — Section 1.  
 ‡ Approximate.  
 † Section 2.  
 ♣ Maximum.  
 ♠ Plate supply voltage.  
 \* Minimum.  
 † Zero Signal.  
 ⊙ For both sections.  
 ⊕ Design maximum rating.

Tube Type	Classification by Construction	Base Connections	Out-line Dwg	Fila-ment Volts	Fila-ment Amp	Max Plate Watts	Max Plate Volts	Max Screen Volts	Capacitance in Micromicrofarads		
									Input	Out-put	Grid-plate
6215	Half-Wave High-Voltage Rectifier	3C	T-X	1.25	0.2	—	Tube Voltage Drop: 56 v at 2.0 ma d-c				
<b>6216</b>	Beam Power Amplifier	9CE	6-3	6.3	1.2	10	300	200	13.2▲	6.7▲	0.37♣▲
6221●	Medium- $\mu$ Triode	8HF	3-1	6.3	0.175	3.3■	165■	—	—	—	—
6222●	High- $\mu$ Triode	8HF	3-1	6.3	0.175	0.55■	165■	—	—	—	—
6223●	Sharp-Cutoff Pentode	8DL	3-1	6.3	0.175	1.1■	165■	155■	4.2	3.4	0.015
6224●	Beam Power Amplifier	8DL	3-3	6.3	0.45	5.0■	165■	155■	6.5	7.5	0.2
6225●	Semi-remote Cutoff Pentode	8DL	3-1	6.3	0.175	1.1■	165■	155■	4.1	3.4	0.015
<i>6227</i>	Power Amplifier Pentode	9BA	6-4	6.3	0.75	8.0■	300■	300■	—	—	—
6245●	Sharp-Cutoff Pentode	5702	3-6	6.3	0.2	1.85■	200■	155■	4.35	3.15	0.03♣
6247●	High- $\mu$ Triode	8FO	3-2	6.3	0.2	1.6■	275■	—	—	—	—
<i>6265</i>	Sharp-Cutoff RF Pentode	7CM	5-2	6.3	0.175	2.0	300	150	5.2▲	4.4▲	0.004♣▲
<i>6267</i>	Power Amplifier Pentode	9BJ	6-2	6.3	0.2	1.0	300	200	—	—	—
6281●	Sharp-Cutoff AF Pentode	5672	2-2	0.625	0.02	—	25■	25■	2.5	3.4	0.01♣
6286●	Medium- $\mu$ Triode	5677	2-1	1.25	0.125	0.45■	100■	—	1.3▲	2.1▲	1.6▲
<i>6287</i>	Beam Power Amplifier	9CT	T-X	6.3	0.6	13.2■	275■	275■	8.0▲	9.0▲	1.1♣▲
6305	Half-Wave High-Voltage Rectifier	6305	T-X	4.0	0.5	—	—	—	—	—	—
6320●	High- $\mu$ Twin Triode	8DG	T-X	6.3	0.085	0.6♣	150	—	1.0	1.4	0.6
6321●	Low- $\mu$ Twin Triode	8DG	T-X	6.3	0.085	0.6♣	150	—	1.0	1.4	0.55
6325	Full-Wave High-Vacuum Rectifier	6325	T-X	6.3	2.7	—	—	—	—	—	—
6327	Beam Power Amplifier	6327	T-X	6.3	1.8	35■	1,650■	330	13▲	13▲	0.6♣▲

Metal tubes are shown in bold-face type, miniature tubes in italics. ●Subminiature type.

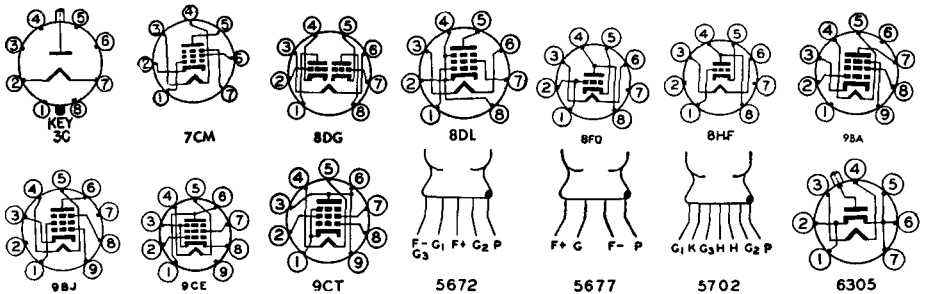

Service	Plate Volts	Screen Volts	Neg Grid Volts	Plate Milli-am-peres	Screen Milli-am-peres	R <sub>p</sub> , Ohms	G <sub>m</sub> , μmhos	μ Factor	Load for Rated Out-put, Ohms	Power Out-put, Watts	Tube Type
Half-Wave Rectifier	Max d-c output current = 1.0 ma; max peak inverse voltage = 18,000 volts; max peak current = 8.0 ma										6215
Class A Amplifier Filter Reactor	200	100	6.0	47†	2.0†	38,000	8,800	—	4,500	3.8	6216
	100	100	3.0	72	3.0	18,500§	12,500	R <sub>g1</sub> = 0.1 meg			
Class A Amplifier	100	—	R <sub>k</sub> = 150	8.5	—	4,700§	5,800	27	—	—	6221 ●
Class A Amplifier	100	—	R <sub>k</sub> = 1500	0.7	—	41,000§	1,700	70	—	—	6222 ●
Class A Amplifier	100	100	R <sub>k</sub> = 150	7.5	2.4	175,000*	5,000	—	—	—	6223 ●
Class A Amplifier	110	110	R <sub>k</sub> = 270	30	2.0	10,000	4,200	—	—	—	6224 ●
Class A Amplifier	100	100	R <sub>k</sub> = 120	7.2	2.0	175,000*	4,500	—	—	—	6225 ●
Class A Amplifier	200	200	R <sub>k</sub> = 130	30	4.1	90,000	9,000	E <sub>c3</sub> = 0 volts	7,000	2.7	6227
Class A Amplifier	120	120	R <sub>k</sub> = 200	7.5	2.6	—	5,000	E <sub>c3</sub> = 0 volts		—	6245 ●
	20	30	0	2.5	1.5♣	—	3,275	E <sub>c3</sub> = 0 volts		—	
Class A Amplifier	250	—	R <sub>k</sub> = 500	4.2	—	22,600§	2,650	60	—	—	6247 ●
Class A Amplifier	250	150	R <sub>k</sub> = 100	7.4	2.9	1,000,000§	4,600	—	—	—	6265
Class A Amplifier	250	140	2.0	3.0	0.6	2,500,000	2,000	E <sub>c3</sub> = 0 volts		—	6267
Class A Amplifier	15	15	1.0	0.05	0.02	2,000,000	105	—	—	—	6281 ●
Class A Amplifier	67.5	—	2.0	6.0	—	5,500§	2,100	11.5	—	—	6286 ●
Class A Amplifier	250	250	12.5	46†	5.0†	55,000	4,100	—	6,000	4.5	6287
Half-Wave Rectifier	Max d-c output current = 5 ma; max peak inverse voltage = 12,500 volts; max rms supply voltage = 5500 volts; max peak current = 40 ma										6305
Class A Amplifier ♣	100	—	R <sub>k</sub> = 680	—	—	33,000§	1,800	60	—	—	6320 ●
Class A Amplifier ♣	100	—	R <sub>k</sub> = 680	—	—	9,400§	1,700	16	—	—	6321 ●
Full-Wave Rectifier	Max d-c output current ☐ = 250 ma; max peak inverse voltage ☐ = 2200 volts; rms supply voltage per plate ☐ = 780 volts; max peak current per plate ☐ = 550 ma										6325
Class A Amplifier	400	300	40	75	3.5	20,000§	5,500	—	—	—	6327
	250	250	22.5	120	7.0	—	8,000	—	—	—	

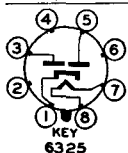

KEY  
6325

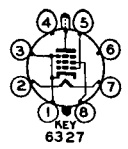

KEY  
6327

- § Approximate.
- ▲ Without external shield.
- † Zero signal.
- ◆ Grids 3 and 5 are screen. Grid 4 is signal-input grid.
- # Conversion transconductance.
- ♣ Maximum.
- ♠ Grids 2 and 4 are screen. Grid 3 is signal-input grid.
- ✱ Screen supply voltage.
- ☐ Absolute maximum rating.
- † Plate-to-plate.
- ♣ Per section.
- ◆ Design maximum rating.

- ⊕ For both sections.
- \* Minimum.
- ¶ Heater warm-up time controlled for series-string service.
- § Plate supply voltage.
- || Input plate.
- ⊖ The duration of the pulse voltage must not exceed 15 percent of one scanning cycle.
- 1—Section 1.
- 2—Section 2.
- ← A resistor of 3 ohms must be put in series with heater.

Tube Type	Classification by Construction	Base Connections	Out-line Dwg	Filament Volts	Filament Amp	Max Plate Watts	Max Plate Volts	Max Screen Volts	Capacitance in Micromicrofarads		
									Input	Out-put	Grid-plate
<i>6350</i>	Medium-Mu Twin Triode	9CZ	6-3	{ 6.3 12.6 }	{ 0.6 0.3 }	3.5♣	300	—	3.6▲	0.6▲	3.2▲
<b>6352</b> ⊙	Temperature-Limited Twin Diode	8EY	3-2	3.0 AC	0.36	—	Max filament voltage □ = 4.0 a-c Max plate voltage □ = 250 d-c Max plate current □ = 1.1 ma ⊕				
<i>6365</i>	Twin Electron-Ray Indicator	6355	T-X	6.3	0.14	—	Max target voltage = 275 v				
<b>6373</b> ⊙	RF Pentode	8CP	3-3	1.25	0.11	1.0	150	150	3.0	7.0	0.1
<i>6374</i>	Half-Wave High-Vacuum Rectifier	9BW	T-X	6.3	1.0	—	Tube Voltage Drop: 22 v at 150 ma d-c				
<b>6375</b> ⊙	Medium-Mu Triode	8DN	3-3	1.25	0.2	2.4	150	—	1.3	1.9	1.4
<b>6384</b>	Beam Power Amplifier	6BQ	T-X	6.3	1.2	30□	750	325	—	—	—
<i>6385</i>	High-Frequency Twin Triode	8CJ	6-2	6.3	0.5	1.5♣	300	—	2.4▲	1.1▲	1.7▲
<i>6386</i>	Medium-Mu Remote-Cutoff Twin Triode	8CJ	6-1	6.3	0.35	1.5♣	300	—	2.0▲	1.1▲	1.2▲
<b>6391</b> ⊙	Sharp-Cutoff Pentode	6391	T-X	6.3	0.2	1.0	175	175	4.0	5.0	0.15♣
<b>6397</b> ⊙	Power Amplifier Pentode	6CL	T-X	{ 2.5 1.25 }	{ 0.0625 0.125 }	1.5□	135□	135□	2.75	3.0	0.055
<i>6414</i>	Twin Triode	9A	6-3	{ 12.6 6.3 }	{ 0.225 0.45 }	2.0◆ 3.6◆ ⊕	200◆	—	4.0▲	0.47 <sub>1</sub> ▲ 0.38 <sub>2</sub> ▲	3.0▲
<i>6448</i>	Half-Wave High-Vacuum Rectifier	9BW	T-X	6.3	1.1	—	Tube Voltage Drop: 25 v at 150 ma d-c				
<i>6463</i>	Medium-Mu Twin Triode	9CZ	6-3	{ 12.6 6.3 }	{ 0.3 0.6 }	4.0♣ 7.0♣	300	—	3.0▲	0.6 <sub>1</sub> ▲ 0.5 <sub>2</sub> ▲	5.0▲
<i>6485</i>	Sharp-Cutoff RF Pentode	7BK	5-2	6.3	0.45	3.2	300	150	10	3.6	0.02♣
<i>6486</i>	Sharp-Cutoff RF Pentode	9DV	6-2	6.3	0.25	2.0	180	140	4.5♣	3.3	0.035♣
<b>6487</b> ⊙	Diode-RF Pentode	8FW	3-2	6.3	0.2	0.75	190□	190□	4.5	4.7	0.02♣
<b>6488</b> ⊙	Remote-Cutoff RF Pentode	8FX	3-2	6.3	0.2	1.5	190□	190□	4.5	5.0	0.15♣
<b>6489</b> ⊙	Diode	6489	T-X	6.3	0.15	—	Tube Voltage Drop: 3.1 v at 18 ma d-c				
<b>6519</b> ⊙	Power Amplifier Pentode	6519	T-X	1.25	0.01	—	30□	30□	R <sub>g1</sub> = 10 meg		

Metal tubes are shown in bold-face type, *miniature tubes in italics.* ⊙Subminiature type.

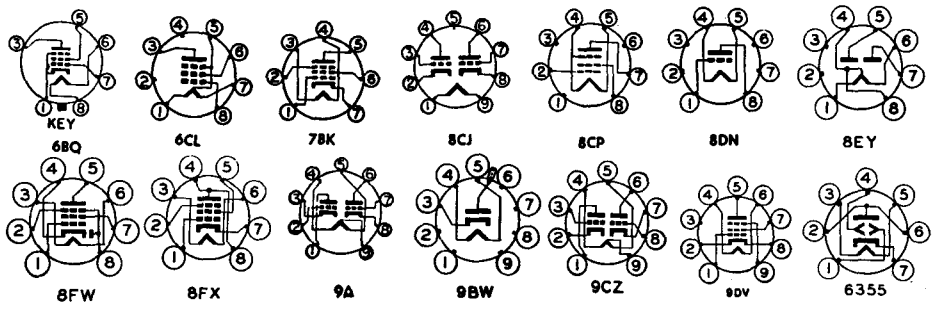



Service	Plate Volts	Screen Volts	Neg Grid Volts	Plate Milliamperes	Screen Milliamperes	R <sub>p</sub> , Ohms	G <sub>m</sub> , μmhos	μ Factor	Load for Rated Output, Ohms	Power Output, Watts	Tube Type
Class A Amplifier ♣	150	—	5.0	11	—	3,900§	4,600	18	—	—	6350
Control Service	Plate voltage = 250 d-c thru 1 meg; plate current = 50 μa ⊕										6352 ⊙
Tuning Indicator	Target voltage = 250 v; Focus-electrode-1 voltage = 120 to 190 v; Focus-electrode-2 voltage = 120 to 190 v										6355
Class A Amplifier	150	90	7.5	6.5	1.4	—	1,500	—	—	—	6373 ⊙
Half-Wave Rectifier	Max d-c output current = 125 ma; max peak inverse voltage = 2000 volts; rms supply voltage = 625 volts; max peak current = 900 ma										6374
Class A Amplifier	150	—	4.5	12	—	4,100§	3,400	14	—	—	6375 ⊙
Horizontal Deflection Amplifier	250	250	22.5	77	3.5	—	5,400	—	—	—	6384
Max positive pulse plate voltage = 1,500 volts; max screen dissipation = 3.5 watts; max d-c cathode current = 125 ma											
Class A Amplifier ♣	150	—	2.0	8.0	—	7,000§	5,000	35	—	—	6385
Class A Amplifier ♣	100	—	R <sub>k</sub> = 200	9.6	—	4,250§	4,000	17	—	—	6386
Class A Amplifier	100	100	1.4	7.0	2.2	180,000	3,000	—	—	—	6391 ⊙
Class A Amplifier	125	125	7.5	7.25	1.2	—	1,950	—	—	—	6397 ⊙
Class A Amplifier ♣	180 150 100	— — —	2.0 4.8 —	8.0 0.15 17	— — —	7,650§ — —	5,550 — —	42.5 — —	— — —	— — —	6414
I <sub>c</sub> = 0.2 ma											
Half-Wave Rectifier	Max d-c output current = 150 ma; max peak inverse voltage = 1,800 volts; max rms supply voltage = 625 volts; max peak current = 900 ma										6443
Class A Amplifier ♣ Frequency Halfer ♣	250	—	R <sub>k</sub> = 620	14.5	—	3,850§	5,200	20	—	—	6463
	100 200	— —	— 11	29 1.0	— —	— —	— —	I <sub>c</sub> = 200 μa	— —	— —	
Class A Amplifier	300	150	R <sub>k</sub> = 160	10	2.5	500,000	9,000	—	—	—	6485
Class A Amplifier	120	120	-2.0	3.5	3.3	—	3,250	E <sub>c3</sub> = 0 volts	—	—	6486
Class A Amplifier	100	100	2.0	3.0	2.45	100,000	2,500	—	—	—	6487 ⊙
Class A Amplifier	100	100	2.0	7.5	2.5	250,000	5,250	—	—	—	6488 ⊙
Half-Wave Rectifier	Max d-c output current ⊠ = 10 ma; max peak inverse voltage ⊠ = 460 volts; max peak current ⊠ = 60 ma										6489 ⊙
Class A Amplifier	22.5	22.5	E <sub>ccl</sub> = 0	0.4	0.1	300,000§	450	—	100000	0.0015	6519 ⊙

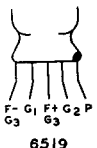
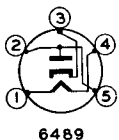
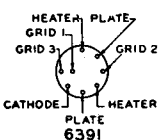

- ✱ Screen supply voltage.
- ⊠ Absolute maximum rating.
- † Plate-to-plate.
- ♣ Per section.
- ⊙ Design maximum rating.
- ⊕ For both sections.
- \* Minimum.
- ¶ Heater warm-up time controlled for series-string service.
- ‡ Plate supply voltage.
- || Input plate.
- The duration of the pulse voltage must not exceed 15 percent of one scanning cycle.
- 1— Section 1.
- 2— Section 2.
- ⊔— A resistor of 3 ohms must be in series with heater.
- § Approximate.
- ▲ Without external shield.
- † Zero signal.
- ♣ Grids 3 and 5 are screen. Grid 4 is signal-input grid.
- # Conversion transconductance.
- ♣ Maximum.
- ♥ Grids 2 and 4 are screen. Grid 3 is signal-input grid.

Tube Type	Classification by Construction	Base Connections	Out-line Dwg	Filament Volts	Filament Amp	Max Plate Watts	Max Plate Volts	Max Screen Volts	Capacitance in Micromicrofarads		
									Input	Out-put	Grid-plate
<i>6525</i>	Thyratron	7BN	5-1	6.3	0.15	—	500	—	Anode voltage drop = 8 volts		
6533	High- $\mu$ Triode	8FY	3-1	6.3	0.2	0.35	150	—	1.75	0.6	1.6
6550	Beam Power Amplifier	7S	T-X	6.3	1.6	35	600	400	14	12	0.85
6611	RF Pentode	6611	2-1	1.25	0.02	0.1	50	50	4.0	4.0	0.008
6612	RF Pentode	6611	2-1	1.25	0.08	0.2	50	50	5.5	4.2	0.01
<i>6680</i>	Remote-Cutoff RF Pentode (Special 6BA6)	7BK	5-2	6.3	0.3	3.0	300	150	5.5	5.5	0.0035
<i>6681</i>	Sharp-Cutoff RF Pentode (Special 6BH6)	7CM	5-2	6.3	0.15	3.0	300	150	5.4	4.4	0.0035
<i>6682</i>	Remote-Cutoff RF Pentode (Special 6BJ6)	7CM	5-2	6.3	0.15	3.0	300	150	4.5	5.5	0.0035
<i>6663</i>	Twin Diode (Special 6AL5)	6BT	5-1	6.3	0.3	—	Tube Voltage Drop: 10 v at 60 ma d-c				
<i>6669</i>	Beam Power Amplifier (Special 6AQ5)	7BZ	5-3	6.3	0.45	12	250	250	Single Tube 2 Tubes, Push Pull		
<i>6677</i>	Power Amplifier Pentode (Special 6CL6)	9BV	6-3	6.3	0.65	8.5	330	165	11	5.5	0.12
<i>6678</i>	Triode-Pentode (Special 6U8)	9AE	6-2	6.3	0.45	3.0 3.0	330 330	165	Pentode Section Triode Section		
<i>6679</i>	High- $\mu$ Twin Triode (Special 12AT7)	9A	6-2	{ 12.6 6.3 }	{ 0.15 0.3 }	2.8	330	—	2.2	1.2 <sub>1</sub> 1.5 <sub>2</sub>	1.5
<i>6680</i>	Medium- $\mu$ Twin Triode (Special 12AU7)	9A	6-2	{ 12.6 6.3 }	{ 0.15 0.3 }	3.0	330	—	1.8	2.0	1.5
<i>6681</i>	High- $\mu$ Twin Triode (Special 12AX7)	9A	6-2	{ 12.6 6.3 }	{ 0.15 0.3 }	1.1	330	—	1.8	1.9	1.7
<i>6686</i>	Power Amplifier Pentode	9BA	6-3	6.3	0.375	4.5	210	210	—	—	—
6690	Medium- $\mu$ Twin Triode	8GQ	T-X	6.3	0.3	1.1	120	—	2.6	1.4 <sub>1</sub> 1.7 <sub>2</sub>	1.8
<i>6754</i>	Full-Wave High-Vacuum Rectifier	9ET	T-X	6.3	1.0	—	—	—	—	—	—
<i>6780</i>	Power Amplifier Pentode	9CE	T-X	18.0	0.35	10	250	200	11	5.0	0.4

Metal tubes are shown in bold-face type, miniature tubes in italics.

⊙Subminiature type.

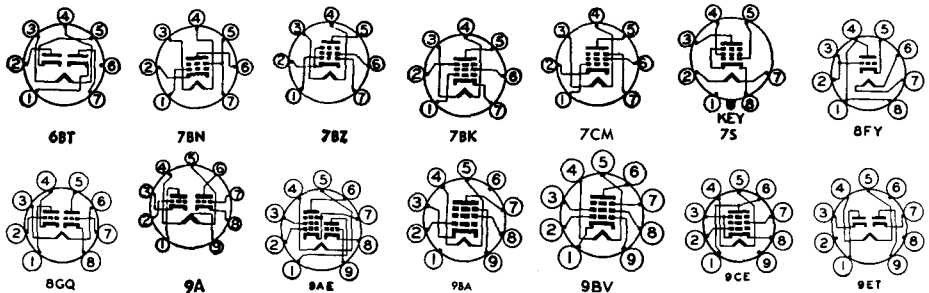

Service	Plate Volts	Screen Volts	Neg Grid Volts	Plate Milli-amperes	Screen Milli-amperes	R <sub>p</sub> , Ohms	Gm, $\mu$ mhos	$\mu$ Factor	Load for Rated Output, Ohms	Power Output, Watts	Tube Type
Relay Energizer	DC control-grid supply voltage for anode conduction: -2.5 volts at E <sub>bb</sub> = 105 volts d-c, E <sub>cc2</sub> = 0 volts, R <sub>L</sub> = 22,000 ohms, R <sub>g2</sub> = 1.0 meg R <sub>g1</sub> = 0										6525
Class A Amplifier	120	—	R <sub>k</sub> = 1500	0.9	—	31,000	1,750	54	—	—	6533 ⊙
Class A Amplifier	400 250	225 250	16.5 14	87 140	4.0 12	27,000 12,000	9,000 11,000	—	3,000 1,500	20 12.5	6550
Class A Amplifier	45 30	45 30	E <sub>cc1</sub> = 0 E <sub>cc2</sub> = 0	1.0 1.0	0.35 0.35	400,000 400,000	1,000 1,000	R <sub>g1</sub> = 5.0 meg; 47 K; R <sub>g2</sub> = 5.0 meg	—	—	6611 ⊙
Class A Amplifier	45 30	45 30	E <sub>cc1</sub> = 0 E <sub>cc2</sub> = 0	3.0 3.0	1.0 1.0	180,000 180,000	3,000 3,000	R <sub>g1</sub> = 2.0 meg; R <sub>g2</sub> = 15k R <sub>g1</sub> = 2.0 meg	—	—	6612 ⊙
Class A Amplifier	250 100	100 100	R <sub>k</sub> = 68 R <sub>k</sub> = 68	11 10.8	4.2 4.4	1,000,000 250,000	4,400 4,300	E <sub>c3</sub> = 0 volts E <sub>c3</sub> = 0 volts	—	—	6660
Class A Amplifier	250	150	R <sub>k</sub> = 100	7.4	2.6	1,400,000	4,600	E <sub>c3</sub> = 0 volts	—	—	6661
Class A Amplifier	250 100	100 100	R <sub>k</sub> = 80 R <sub>k</sub> = 80	9.2 9.0	3.3 3.5	1,300,000 250,000	3,600 3,650	E <sub>c3</sub> = 0 volts E <sub>c3</sub> = 0 volts	—	—	6662
Rectifier Service	Max d-c output current per plate = 9.0 ma; max peak inverse voltage = 250 volts; max peak current per plate = 54 ma										6663
Class A Amplifier	250	250	12.5	45†	4.5†	52,000	4,100	—	5,000	4.5	6669
Class AB <sub>1</sub> Amplifier	250	250	15	70†	5.0†	—	—	—	10,000 ‡	10	6670
Class A Amplifier	250	150	3.0	30†	7.0†	150,000	11,000	g <sub>3</sub> tied to k	7,500	2.8	6677
Class A Amplifier	250	110	R <sub>k</sub> = 68	10	3.5	400,000	5,200	—	—	—	6678
Class A Amplifier	150	—	R <sub>k</sub> = 56	18	—	5,000	8,500	40	—	—	6679
Class A Amplifier †	250	—	R <sub>k</sub> = 200	10	—	10,900	5,500	60	—	—	6679
Class A Amplifier	250 100	— —	8.5 0	10.5 11.8	— —	7,700 6,500	2,200 3,100	17 20	— —	— —	6680
Class A Amplifier †	250 100	— —	2.0 1.0	1.2 0.5	— —	62,000 80,000	1,600 1,250	100 100	— —	— —	6681
Class A Amplifier	210	210	R <sub>k</sub> = 120	20†	5.3†	300,000	11,000	E <sub>c3</sub> = 0 v	15,000	1.0	6686
Class A Amplifier †	100	—	R <sub>k</sub> = 100	8.0	—	—	4,800	35	—	—	6690 ⊙
Full-Wave Rectifier	Max d-c output current = 90 ma; max peak inverse voltage = 1,450 volts; rms supply voltage = 325 volts; max peak current per plate = 330 ma										6754
Class A Amplifier	130	130	R <sub>k</sub> = 100	70	3.5	—	12,000	—	2,000	3.0	6760

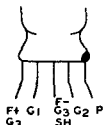

6611

§ Approximate.

▲ Without external shield.

† Zero signal.

◆ Grids 3 and 5 are screen. Grid 4 is signal-input grid.

# Conversion transconductance.

♣ Maximum.

▼ Grids 2 and 4 are screen. Grid 3 is signal-input grid.

✱ Screen supply voltage.

⊙ Absolute maximum rating.

‡ Plate-to-plate.

♠ Per section.

◆ Design maximum rating.

⊕ For both sections.

\* Minimum.

† Heater warm-up time controlled for series-string service.

‡ Plate supply voltage.

|| Input plate.

|| The duration of the pulse voltage must not exceed 15 percent of one scanning cycle.

1—Section 1.

2—Section 2.

4—A resistor of 3 ohms must be put in series with heater.

Tube Type	Classification by Construction	Base Connections	Out-line Dwg	Filament Volts	Filament Amp	Max Plate Watts	Max Plate Volts	Max Screen Volts	Capacitance in Micromicrofarads		
									Input	Output	Grid-plate
6761	Power Amplifier Pentode	9CE	T-X	6.3	1.0	10	250	200	11▲	5.0▲	0.4▲
6788◎	Sharp-Cutoff Pentode	8DL	T-X	6.3	0.175	0.5□	250□	150□	2.5	3.2	0.032
6792	High-Vacuum Beam Tetrode	8GL	T-X	6.3	0.45	25	25,000	—	2.0▲	4.0▲	0.03▲
6814◎	Medium- $\mu$ Triode	8DK	3-1	6.3	0.15	2.0	250	—	2.4	2.4	1.3
6829	Twin Triode	9A	6-3	12.6 6.3	0.225 0.45	2.2◆ 4.0◆ ⊕	275◆	—	4.0▲	0.51▲ 0.382▲	3.0▲
6842	High-Voltage Regulator	7EQ	T-X	6.3	—	8.0	4000	150	3.95▲	1.34▲	0.067▲
6888	Dual-Control Pentode	8N	9-12	6.3	0.8	8.0□	250□	150□	12▲	6.5▲	0.7▲
9001	Detector Amplifier Pentode	7BD	5-1	6.3	0.15	—	250	100	3.6	3.0	0.01♣
9002	Medium-Mu Triode	7BS	5-1	6.3	0.15	—	250	—	1.2	1.1	1.4
9003	Remote-Cutoff Pentode	7BD	5-1	6.3	0.15	—	250	100	3.6	3.0	0.01♣
9004	High-Frequency Diode (Acorn)	4BJ	4-1	6.3	0.15	—	—	—	—	—	—
9005	High-Frequency Diode (Acorn)	5BG	4-1	3.6	0.165	—	—	—	—	—	—
9006	High-Frequency Diode	6BH	5-1	6.3	0.15	—	—	—	—	—	—

Metal tubes are shown in bold-face type, miniature tubes in *italics*. ◎Subminiature type.

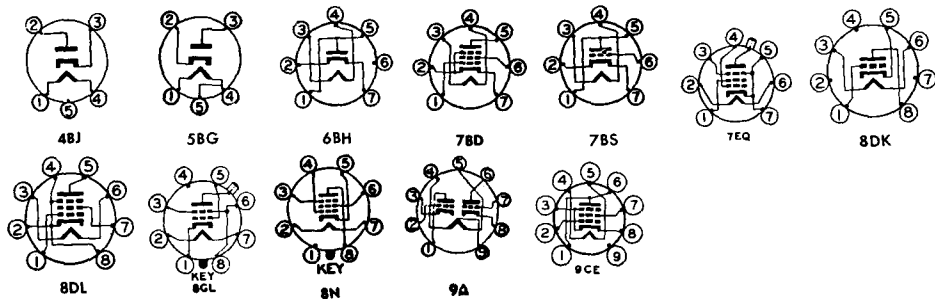

Service	Plate Volts	Screen Volts	Neg Grid Volts	Plate Milli-am-peres	Screen Milli-am-peres	$R_p$ , Ohms	$G_m$ , $\mu$ mhos	$\mu$ Factor	Load for Rated Output, Ohms	Power Out-put, Watts	Tube Type
Class A Amplifier	130	130	$R_k = 100$	70	3.5	—	12,000	—	2,000	3.0	6761
Class A Amplifier	100	100	$R_k = 1500$	0.8	0.09	1,200,000	1,150	—	—	—	6788 ⊙
High-Voltage Shunt Regulator	25,000	200	18	1.0	0.1	10,000,000	195§	—	—	—	6792
Max screen dissipation = 1.0 watts; max d-c cathode current = 10 ma											
Class A Amplifier	100	—	$R_k = 150$	10	—	4,800§	6,000	29	—	—	6814 ⊙
Class A Amplifier †	150	—	$R_k = 220$	8.5	—	7,000§	6,700	47	—	—	6829
	150	—	4.8	0.15	—	—	—	—	—	—	
	100	—	—	17	—	—	—	$I_c = 0.2$ ma	—	—	
Class A Amplifier	1500	100	1.0	4.5	0.5	930,000§	2,500	—	—	—	6842
Gated Amplifier	150	90	—	37.5	19	$I_c = 190 \mu a$	—	—	$E_{c3} = 0$ volts	—	6888
	150	90	9.4	2.5	—	—	—	—	$E_{c3} = 0$ volts	—	
	150	90	13.8	0.03	—	—	—	—	$E_{c3} = 0$ volts	—	
	150	90	0	2.0	—	—	—	—	$E_{c3} = -8.6$ volts	—	
Class A Amplifier	250	100	3.0	2.0	0.7	1,000,000*	1,400	—	—	—	9001
Class A Amplifier	250	—	7.0	6.3	—	11,400	2,200	25	—	—	9002
Class A Amplifier	250	100	3.0	6.7	2.7	700,000	1,800	—	—	—	9003
Half-Wave Rectifier	Max d-c output current = 5 ma; max rms supply voltage = 117 volts										9004
Half-Wave Rectifier	Max d-c output current = 1.0 ma; max rms supply voltage = 117 volts										9005
Half-Wave Rectifier	Max d-c output current = 5 ma; max peak inverse voltage = 750 volts; rms supply voltage = 270 volts; max peak current = 15 ma										9006

§ Approximate.

▲ Without external shield.

† Zero signal.

♦ Grids 3 and 5 are screen. Grid 4 is signal-input grid.

# Conversion transconductance.

♣ Maximum.

♥ Grids 2 and 4 are screen. Grid 3 is signal-input grid.

✱ Screen supply voltage.

⊙ Absolute maximum rating.

‡ Plate-to-plate.

♠ Per section.

⊕ Design maximum rating.

⊕ For both sections.

\* Minimum.

† Heater warm-up time controlled for series-string service.

§ Plate supply voltage.

|| Input plate.

3—The duration of the pulse voltage must not exceed 15 percent of one scanning cycle.

1—Section 1.

2—Section 2.

4—A resistor of 3 ohms must be put in series with heater.

Type	Base Connections	Construction	Face-plate Shape	Face-plate Finish	Ext'l Conductive Coating	Anode Contact	Focus Method	Defl Method	Defl Angle Degrees †	Nom Over-all Length Inches	Nom Bulb Diam Inches †
3KP4	11M	Glass	Round	C	No	Base	Elec	Elec	—	11½	3
3NP4●	5BV	Glass	Round	C; A	Yes	Cavity	Mag	Mag	42	10	2½
5AHP4	8EF	Glass	Round	C	No	Ball	Elec	Mag	53	11½	4½
5AHP4-A	8EF	Glass	Round	C; A	No	Ball	Elec	Mag	53	11½	4½
5ALP4	9DF	Glass	Round	C	No	Ball	Mag	Mag	—	7¼	4¾
5AXP4	12S	Glass	Round	C	No	Cavity	Elec	Mag	53	10⅝	4½
5AYP4	5AYP4	Glass	Round	C; A	Yes	Ball	Elec	Mag	53	11⅞	4½
5AZP4●	12AA	Glass	Round	C; A	No	Cable	Elec	Mag	50	12⅞	5
5BP4	11A	Glass	Round	C	No	Base	Elec	Elec	—	16¾	5¼
5FP4-A	5AN	Glass	Round	C	No	Ball	Mag	Mag	53	11⅞	4½
5QP4	5AN	Glass	Round	C; A	No	Ball	Mag	Mag	53	11⅞	4½
5QP4-A	5AN	Glass	Round	C; A	No	Ball	Mag	Mag	53	11⅞	4½
5TP4●	12C	Glass	Round	C; A	Yes	Cavity	Elec	Mag	50	11¾	5
7AP4	5AJ	Glass	Round	C	No	Base	Elec	Mag	55	7⅞	7
7CP4	8BQ	Glass	Round	C	No	Ball	Elec	Mag	57	13⅞	7
7DP4	12C	Glass	Round	C	Yes	Cavity	Elec	Mag	50	14⅞	7½
7EP4	11N	Glass	Round	C	No	Base	Elec	Elec	—	15½	7
7GP4	14G	Glass	Round	C	No	Base	Elec	Elec	—	14½	7
7HP4	12N	Glass	Round	C	Yes	Ball	Mag	Mag	50	13	7½
7JP4	14G	Glass	Round	C	No	Base	Elec	Elec	—	14½	7
7NP4●	14N	Glass	Round	C; A	No	Cap	Elec	Mag	35	19½	7
7QP4	12D	Glass	Round	C	No	Cavity	Mag	Mag	52	12⅞	7½
7RP4	12N	Glass	Round	C; A	Yes	Cavity	Mag	Mag	50	14⅞	7½
7TP4	12Q	Glass	Round	C; A	No	Cavity	Elec	Mag	50	13⅞	7½
7WP4●	14N	Glass	Round	C; A	Yes	Cap	Elec	Mag	35	19⅞	7

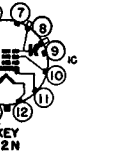
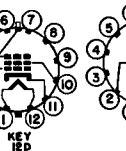
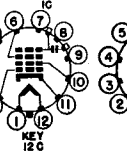
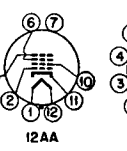
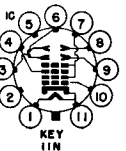
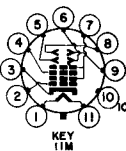
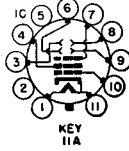
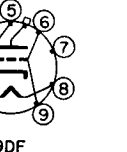
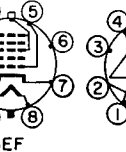
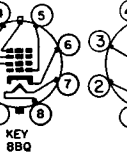
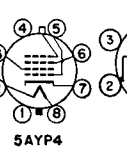
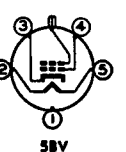
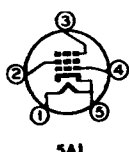

Heater Volts/ Amp	Max Anode Volts	Max Grid 2 Volts	Typical Operating Conditions							Type
			Anode Volts	Grid 2 Volts	Neg Grid 1 Cutoff Volts	RETMA Focus Coil No.	Focus Coil Dist†	Focus Current in ma	Ion Trap Magnet	
6.3/0.6	2,500 $\Delta$ 1,000 $\bullet$	—	2,000 $\Delta$ 460 $\bullet$	—	38 to 90†	D1-D2 $\diamond$ = 100 to 136 volts/inch D3-D4 $\diamond$ = 76 to 104 volts/inch			3KP4	
6.3/0.6	25,000	—	24,000	—	36 to 84†	—	2.78	120	None	3NP4 $\bullet$
6.3/0.6	10,000 $\Delta$ +1,000 -500 $\bullet$	700	7,000 $\Delta$ 125 $\bullet$	300	28 to 72*	—	—	—	—	5AHP4
6.3/0.6	10,000 $\Delta$ +1,000 -500 $\bullet$	700	7,000 $\Delta$ 125 $\bullet$	300	28 to 72*	—	—	—	—	5AHP4-A
6.3/0.2	10,000	—	8,000	—	50†	—	—	—	—	5ALP4
6.3/0.6	18,000	500	14,000	300	28 to 72*	—	—	—	—	5AXP4
6.3/0.6	10,000 $\Delta$ 1,500 $\bullet$	410	7,000 $\Delta$ 835 $\bullet$	200	17 to 47*	—	—	—	—	5AYP4
6.3/0.6	40,000 $\Delta$ 9,000 $\bullet$	400	36,000 $\Delta$ 7,375 $\bullet$	200	37 to 93*	—	—	—	—	5AZP4 $\bullet$
6.3/0.6	2,000 $\Delta$ 1,000 $\bullet$	—	2,000 $\Delta$ 425 $\bullet$	—	40†	D1-D2 $\diamond$ = 85 volts/inch D3-D4 $\diamond$ = 76 volts/inch			5BP4	
6.3/0.6	8,000	410	6,000	250	25 to 70†	106	3 1/4	120	None	5FP4-A
6.3/0.6	12,000	410	10,000	300	28 to 72*	106	2 3/4	137	None	5QP4
6.3/0.6	12,000	700	10,000	300	33 to 77†	106	2 3/4	137	None	5QP4-A
6.3/0.6	27,000 $\Delta$ 6,000 $\bullet$	350	27,000 $\Delta$ 4,900 $\bullet$	200	42 to 98†	—	—	—	None	5TP4 $\bullet$
2.5/2.1	3,500	1000	3,500	675	67.5†	—	—	—	None	7AP4
6.3/0.6	8,000 $\Delta$ 2,400 $\bullet$	300	6,000 $\Delta$ 1,140 $\bullet$	250	22 to 68†	—	—	—	None	7CP4
6.3/0.6	8,000 $\Delta$ 2,400 $\bullet$	410	6,000 $\Delta$ 1,430 $\bullet$	250	24 to 62*	—	—	—	Double	7DP4
6.3/0.6	3,300 $\Delta$ 1,500 $\bullet$	—	2,500 $\Delta$ 650 $\bullet$	—	36 to 84†	D1-D2 $\diamond$ = 88 to 132 volts/inch D3-D4 $\diamond$ = 76 to 114 volts/inch			7EP4	
6.3/0.6	4,000 $\Delta$ 1,500 $\bullet$	—	3,000 $\Delta$ 1,000 $\bullet$	—	36 to 84†	D1-D2 $\diamond$ = 93 to 123 volts/inch D3-D4 $\diamond$ = 75 to 102 volts/inch			7GP4	
6.3/0.6	8,000	410	6,000	250	33 to 77	106	3.5	135	None	7HP4
6.3/0.6	6,000 $\Delta$ 2,800 $\bullet$	—	6,000 $\Delta$ 2,010 $\bullet$	—	72 to 168 †	D1-D2 $\diamond$ = 186 to 246 volts/inch D3-D4 $\diamond$ = 150 to 204 volts/inch			7JP4	
6.6/0.62	80,000 $\Delta$ 20,000 $\bullet$	600	75,000 $\Delta$ 16,000 $\bullet$	500	155†	—	—	—	None	7NP4 $\bullet$
6.3/0.6	10,000	410	8,000	300	28 to 72*	109	3.0	80	Single	7QP4
6.3/0.6	12,000	410	9,000	250	24 to 62*	106	3 1/4	120	None	7RP4
6.3/0.6	12,000 $\Delta$ 2,000 $\bullet$	410	10,000 $\Delta$ 1,370 $\bullet$	200	22 to 52†	—	—	—	None	7TP4
6.6/0.62	80,000 $\Delta$ 20,000 $\bullet$	600	75,000 $\Delta$ 16,000 $\bullet$	500	155†	—	—	—	None	7WP4 $\bullet$

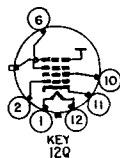

KEY 12Q

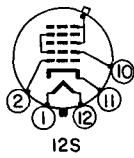

KEY 12S

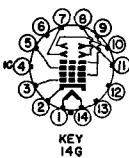

KEY 14G

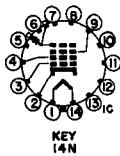

KEY 14N

A—Aluminized screen to increase light output.

C—Clear (untinted) faceplate.

G—Grey (filter) faceplate.

† Diagonal measurement for rectangular tubes.

‡ Distance between yoke reference line and center of focus-coil air gap; in inches.

$\Delta$  Accelerator anode and collector.

$\bullet$  Anode No. 1 (Focus); under typical operating conditions center value of voltage for focus is shown. Voltage should be adjustable about this value.

† For visual extinction of undeflected focused spot.

$\diamond$  Deflection factor.

$\bullet$  Designates projection type.

\* For visual extinction of focused raster.

THERMION TUBE TYPES

Type	Base Con- nections	Con- struction	Face- plate Shape	Face- plate Finish	Ext'l Con- duc- tive Coating	Anode Con- tact	Focus Meth- od	Defl Meth- od	Defl Angle Degrees †	Nom Over-all Length Inches	Nom Bulb Diam Inches‡
8AP4	12H	Metal	Round	C	Metal	Cone	Mag	Mag	54	14¼	8½
8AP4-A	12H	Metal	Round	G	Metal	Cone	Mag	Mag	54	14¼	8½
8BP4	14G	Glass	Round	C	No	Base	Elec	Elec	—	16½	8¾
8DP4	12AB	Glass	Rect	G	Yes	Cavity	Elec	Mag	90	10⅞	8⅞
8XP4	12S	Glass	Rect	G	No	Cavity	Elec □	Mag	90	11⅞	8⅞
9AP4	6AL	Glass	Round	C	No	Cap	Elec	Mag	40	21	9
9CP4	4AF	Glass	Round	C	No	Cap	Mag	Mag	—	15¾	9⅞
9QP4	12AD	Glass	Rect	C	No	None	Elec	Mag	70	12¼	8¾
10ABP4	12L	Glass	Rect	C	Yes	Cavity	Elec	Mag	90	11¾	10¾
10ABP4-A	12L	Glass	Rect	C; A	Yes	Cavity	Elec	Mag	90	11¾	10¾
10ABP4-B	12L	Glass	Rect	G	Yes	Cavity	Elec	Mag	90	11¾	10¾
10BP4	12N	Glass	Round	C	Yes	Cavity	Mag	Mag	50	17¾	10½
10BP4-A	12N	Glass	Round	G	Yes	Cavity	Mag	Mag	50	17¾	10½
10BP4-C	12N	Glass	Round	C; A	Yes	Cavity	Mag	Mag	50	17¾	10½
10BP4-D	12N	Glass	Round	G; A	Yes	Cavity	Mag	Mag	50	17¾	10½
10CP4	12N	Glass	Round	C	Yes	Ball	Mag	Mag	50	16¾	10½
10DP4	12M	Glass	Round	C; A	No	Cavity	Elec	Mag	50	17¾	10½
10FP4	12N	Glass	Round	C; A	Yes	Cavity	Mag	Mag	50	17¾	10½
10FP4-A	12N	Glass	Round	G; A	Yes	Cavity	Mag	Mag	50	17¾	10½
10GP4	14G	Glass	Round	C	No	Base	Elec	Elec	—	18½	10½
10HP4	14G	Glass	Round	C	No	Base	Elec	Elec	—	19¼	10
10MP4	12G	Glass	Round	C	Yes	Cavity	Mag	Mag	52	17	10½
10MP4-A	12G	Glass	Round	G	Yes	Cavity	Mag	Mag	50	17	10½
10RP4	12L	Glass	Round	C; A	Yes	Cavity	Elec	Mag	50	16½	10½
10SP4	12Q	Glass	Round	G;A	No	Cavity	Elec	Mag	50	16¾	10½

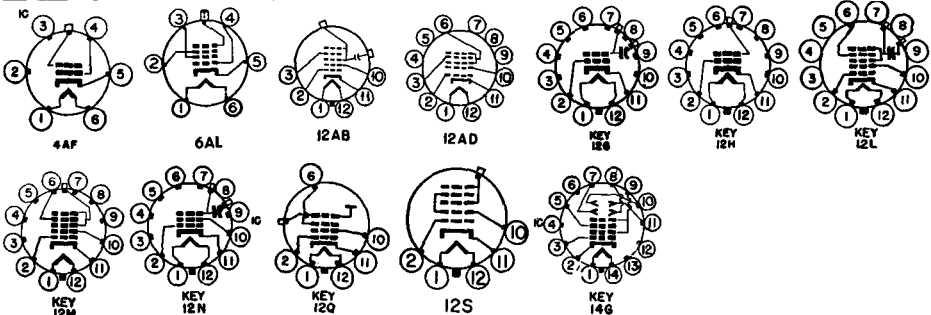



Heater Volts/ Amp	Max Anode Volts	Max Grid 2 Volts	Typical Operating Conditions							Type
			Anode Volts	Grid 2 Volts	Neg Grid 1 Cutoff Volts	RETMA Focus Coil No.	Focus Coil Dist†	Focus Current in ma	Ion Trap Magnet	
6.3/0.6	9,000	—	7,000	—	24 to 62*	106	3¼	115	Single	8AP4
6.3/0.6	9,000	—	7,000	—	24 to 62*	106	3¼	115	Single	8AP4-A
6.3/0.6	6,600 Δ 3,100 ●	—	6,000 Δ 2,010 ●	—	72 to 168 †	D1-D2 ◆ = 146 to 198 volts/inch D3-D4 ◆ = 124 to 168 volts/inch			Single	8BP4
6.3/0.6	8,000 □ 500 ●	400	6,000 Δ 165 ●	150	13 to 29*	—	—	—	Single	8DP4
6.3/0.6	20,000	500	16,000	300	28 to 72*	—	—	—	None	8XP4
2.5/2.1	7,000 Δ 2,000 ●	250	7,000 Δ 1,425 ●	250	75†	—	—	—	None	9AP4
2.5/2.1	7,000	—	6,000	—	90†	—	—	—	None	9CP4
4.7/0.3	6,800 Δ +1,000 -500 ● □	300	5,500 Δ 200 ●	200	+28 to +52*	—	—	—	Single	9QP4
6.3/0.6	12,000 Δ +1,000 -500 ●	500	7,500 Δ 250 ●	300	38 to 62*	—	—	—	Single	10ABP4
6.3/0.6	12,000 Δ +1,000 -500 ●	500	7,500 Δ 250 ●	300	38 to 62*	—	—	—	Single	10ABP4-A
6.3/0.6	12,000 Δ +1,000 -500 ●	500	7,500 Δ 250 ●	300	38 to 62*	—	—	—	Single	10ABP4-B
6.3/0.6	12,000	410	11,000	300	28 to 72*	109	4½	100	Double	10BP4
6.3/0.6	12,000	410	11,000	300	28 to 72*	109	4½	100	Double	10BP4-A
6.3/0.6	10,000	410	9,000	300	28 to 72*	106	3¼	110	Single	10BP4-C
6.3/0.6	10,000	410	9,000	300	28 to 72*	106	3¼	110	Single	10BP4-D
6.3/0.6	12,000	450	9,000	250	30 to 66†	—	—	—	None	10CP4
6.3/0.6	10,000 Δ 3,600 ●	410	9,000 Δ 2,900 ●	250	36 to 84†	—	—	—	None	10DP4
6.3/0.6	12,000	410	11,000	300	28 to 72*	106	3¼	110	None	10FP4
6.3/0.6	12,000	410	11,000	300	28 to 72*	106	3¼	110	None	10FP4-A
6.3/0.6	5,000 Δ 2,000 ●	—	5,000 Δ 1,550 ●	—	60 to 140 †	D1-D2 ◆ = 125 to 165 volts/inch D3-D4 ◆ = 100 to 135 volts/inch			Single	10GP4
6.3/0.6	5,000 Δ 2,000 ●	—	5,000 Δ 1,500 ●	—	60 to 140 †	D1-D2 ◆ = 110 to 150 volts/inch D3-D4 ◆ = 85 to 115 volts/inch			Single	10HP4
6.3/0.6	10,000	—	9,000	—	24 to 62*	—	—	—	Double	10MP4
6.3/0.6	10,000	—	9,000	—	24 to 62*	—	—	—	Double	10MP4-A
6.3/0.6	16,000 Δ +1,000 -500 ●	500	14,000 Δ 123 ●	300	28 to 72*	—	—	—	None	10RP4
6.3/0.6	14,000 Δ 2,700 ●	410	12,000 Δ 1,650 ●	200	18 to 48*	—	—	—	None	10SP4

A—Aluminized screen to increase light output.

C—Clear (untinted) faceplate.

F—Frosted faceplate surface to reduce reflection.

G—Grey (filter) faceplate.

¶ Diagonal measurement for rectangular tubes.

† Distance between yoke reference line and center of focus-coil air gap, in inches.

Δ Accelerator anode and collector.

● Anode No. 1 (Focus); under typical operating conditions center value of voltage for focus is shown. Voltage should be adjustable about this value.

† For visual extinction of undeflected focused spot.

◆ Deflection factor.

● Designates projection type.

□ Cathode-drive service.

\* For visual extinction of focused raster.

□ Automatic electrostatic focus. No external focus connection required.

▲ Intensifier No. 3 Anode.

‡ Accelerator No. 2 Anode.

⊕ Center value of voltage for convergence is shown. Modulation should be applied to improve over-all convergence.

⊞ With cylindrical contour.

Type	Base Connections	Construction	Face-plate Shape	Face-plate Finish	Ext'l Conductive Coating	Anode Contact	Focus Method	Defl Method	Defl Angle Degrees¶	Nom Over-all Length Inches	Nom Bulb Diam Inches¶¶
12AP4	6AL	Glass	Round	C	No	Cap	Elec	Mag	35	25	12
12CP4	4AF	Glass	Round	C	No	Cap	Mag	Mag	—	18½	12
12JP4	12D	Glass	Round	C	No	Ball	Mag	Mag	56	17½	12
12KP4	12N	Glass	Round	C; A	Yes	Cavity	Mag	Mag	54	17½	12 7/16
12KP4-A	12N	Glass	Round	G; A	Yes	Cavity	Mag	Mag	54	17½	12 7/16
12LP4	12N	Glass	Round	C	Yes	Cavity	Mag	Mag	54	18¾	12 7/16
12LP4-A	12N	Glass	Round	G	Yes	Cavity	Mag	Mag	54	18¾	12 7/16
12LP4-C	12N	Glass	Round	G; A	Yes	Cavity	Mag	Mag	54	18¾	12 7/16
12QP4	12D	Glass	Round	C	No	Ball	Mag	Mag	55	17½	12
12QP4-A	12D	Glass	Round	G	No	Ball	Mag	Mag	54	17½	12
12RP4	12D	Glass	Round	C	No	Ball	Mag	Mag	56	17½	12
12TP4	12D	Glass	Round	C	No	Cavity	Mag	Mag	54	18¾	12
12UP4	12D	Metal	Round	C	Metal	Cone	Mag	Mag	54	18¾	12 7/16
12UP4-A	12D	Metal	Round	G	Metal	Cone	Mag	Mag	54	18¾	12 7/16
12UP4-B	12D	Metal	Round	G; F	Metal	Cone	Mag	Mag	54	18¾	12 7/16
12VP4	12G	Glass	Round	C	Yes	Cavity	Mag	Mag	55	18	12 7/16
12VP4-A	12G	Glass	Round	G	Yes	Cavity	Mag	Mag	55	18	12 7/16
12WP4	12WP4	Glass	Round	G	Yes	Special	Mag	Mag	55	17¾	12 7/16
12XP4	12N	Glass	Round	C	Yes	Cavity	Mag	Mag	60	18¼	12
12YP4	12N	Glass	Round	G	Yes	Cavity	Elec □	Mag	54	18¾	12 7/16
12ZP4	12N	Glass	Round	C; A	Yes	Cavity	Mag	Mag	54	17½	12 7/16
12ZP4-A	12N	Glass	Round	G; A	Yes	Cavity	Mag	Mag	54	17½	12 7/16
14AP4	12A	Glass	Round	C	No	Base	Elec	Elec	—	24¼	13½
14BP4	12N	Glass	Rect	G	Yes	Cavity	Mag	Mag	70	16 1/2	13 1/2
14BP4-A	12N	Glass	Rect	G	Yes	Cavity	Mag	Mag	70	16¾	13 1/2
14CP4	12N	Glass	Rect	G	Yes	Cavity	Mag	Mag	70	16¾	13 1/2
14CP4-A	12N	Glass	Rect	G; A	Yes	Cavity	Mag	Mag	70	16¾	13 1/2
14DP4	12D	Glass	Rect	G	No	Cavity	Mag	Mag	70	16¾	13 1/2
14EP4	12N	Glass	Rect	G	Yes	Cavity	Mag	Mag	70	16½	13 1/2
14GP4	12L	Glass	Rect	G	Yes	Cavity	Elec	Mag	70	16 1/2	13 1/2
14HP4	12L	Glass	Rect	G	Yes	Cavity	Elec	Mag	70	16 1/2	13 1/2

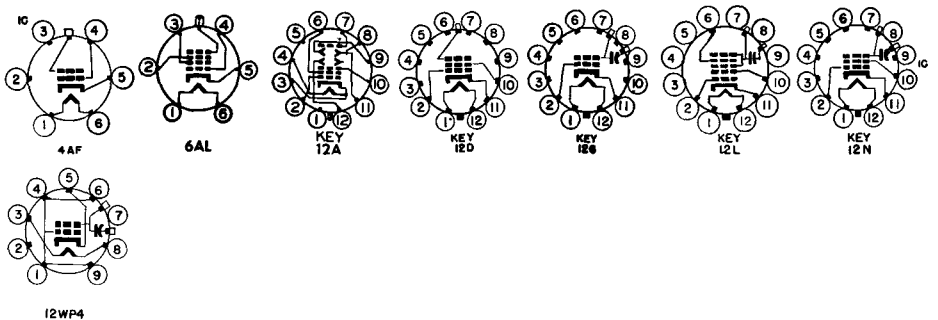

Heater Volts/ Amp	Max Anode Volts	Max Grid 2 Volts	Typical Operating Conditions							Type
			Anode Volts	Grid 2 Volts	Neg Grid 1 Cutoff Volts	RETMA Focus Coil No.	Focus Coil Dist†	Focus Current in ma	Ion Trap Magnet	
2.5/2.1	7,000 $\Delta$ 1,900 $\bullet$	250	7,000 $\Delta$ 1,460 $\bullet$	250	75†	—	—	—	None	12AP4
2.5/2.1	7,000	—	7,000	—	110†	—	—	—	None	12CP4
6.3/0.6	12,000	410	10,000	250	24 to 62*	106	3.0	146	None	12JP4
6.3/0.6	12,000	410	11,000	300	28 to 72*	106	3¼	135	None	12KP4
6.3/0.6	12,000	410	11,000	300	28 to 72*	106	3¼	135	None	12KP4-A
6.3/0.6	12,000	410	11,000	300	28 to 72*	106	3¼	110	Double	12LP4
6.3/0.6	12,000	410	11,000	300	28 to 72*	106	3¼	110	Double	12LP4-A
6.3/0.6	12,000	410	11,000	300	28 to 72*	106	3¼	110	Double	12LP4-C
6.3/0.6	12,000	410	10,000	250	24 to 62*	106	3.0	135	Single	12QP4
6.3/0.6	12,000	410	10,000	250	24 to 62*	106	3	135	Single	12QP4-A
6.3/0.6	12,000	410	10,000	250	24 to 62*	106	3.0	135	Single	12RP4
6.3/0.6	12,000	410	11,000	250	24 to 62*	106	3¼	110	Double	12TP4
6.3/0.6	12,000	410	11,000	250	24 to 62*	106	3¼	110	Single	12UP4
6.3/0.6	12,000	410	11,000	250	24 to 62*	106	3¼	110	Single	12UP4-A
6.3/0.6	12,000	410	11,000	250	24 to 62*	106	3¼	130	Single	12UP4-B
6.3/0.6	12,000	—	11,000	—	28 to 72*	—	—	—	Double	12VP4
6.3/0.6	12,000	—	11,000	—	28 to 72*	—	—	—	Double	12VP4-A
6.3/0.6	12,000	—	10,000	—	24 to 62*	Special PM Unit			Single	12WP4
6.3/0.6	9,000	380	8,000	250	24 to 62*	—	—	—	Single	12XP4
6.3/0.6	12,000	410	11,000	250	33 to 73†	—	—	—	Single	12YP4
6.3/0.6	12,000	410	11,000	300	28 to 72*	106	3¼	135	Single	12ZP4
6.3/0.6	12,000	410	11,000	300	28 to 72*	106	3¼	135	Single	12ZP4-A
2.5/2.1	8,000 $\blacktriangle$ 4,000 $\blacklozenge$	1800 $\bullet$	8,000 $\blacktriangle$ 4,000 $\blacklozenge$	1000 $\bullet$	40 to 120 †	D1-D2 $\blacklozenge$ = 104 to 156 volts/inch D3-D4 $\blacklozenge$ = 104 to 156 volts/inch				14AP4
6.3/0.6	12,000	410	11,000	250	24 to 62*	106	3¼	110	Double	14BP4
6.3/0.6	12,000	410	11,000	250	24 to 62*	106	3¼	95	Double	14BP4-A
6.3/0.6	14,000	410	12,000	300	33 to 77*	109	3.0	92	Single	14CP4
6.3/0.6	14,000	410	12,000	300	33 to 77†	109	3.0	92	Single	14CP4-A
6.3/0.6	14,000	410	11,000	250	24 to 62*	109	3.0	100	Double	14DP4
6.3/0.6	14,000	410	12,000	300	28 to 72*	109	3.0	110	Single	14EP4
6.3/0.6	14,000 $\Delta$ 5,000 $\bullet$	500	12,000 $\Delta$ 2,550 $\bullet$	300	28 to 72*	—	—	—	Single	14GP4
6.3/0.6	14,000 $\Delta$ +1,000, -500 $\bullet$	410	12,000 $\Delta$ 108 $\bullet$	300	28 to 72*	—	—	—	Single	14HP4

A—Aluminized screen to increase light output.

C—Clear (untinted) faceplate.

F—Frosted faceplate surface to reduce reflection.

G—Grey (filter) faceplate.

‡ Diagonal measurement for rectangular tubes.

† Distance between yoke reference line and center of focus-coil air gap; in inches.

$\Delta$  Accelerator anode and collector.

$\bullet$  Anode No. 1 (Focus); under typical operating conditions center value of voltage for focus is shown. Voltage should be adjustable about this value.

† For visual extinction of undeflected focused spot.

$\blacklozenge$  Deflection factor.

$\bullet$  Designates projection type.

\* For visual extinction of focused raster.

$\square$  Automatic electrostatic focus. No external focus connection required.

$\blacktriangle$  Intensifier No. 3 Anode.

$\blacklozenge$  Accelerator No. 2 Anode.

$\oplus$  Center value of voltage for convergence is shown. Modulation should be applied to improve over-all convergence.

$\text{||}$  With cylindrical contour.

Type	Base Connections	Construction	Face-plate Shape	Face-plate Finish	Ext'l Conductive Coating	Anode Contact	Focus Method	Defl Method	Defl Angle Degrees	Nom Over-all Length Inches	Nom Bulb Diam Inches
14KP4	12N	Glass	Rect	C	Yes	Small Cap	Mag	Mag	70	16 $\frac{3}{4}$	13 $\frac{1}{2}$
14KP4-A	12N	Glass	Rect	G	Yes	Small Cap	Mag	Mag	70	16 $\frac{1}{2}$	13 $\frac{1}{2}$
14NP4	12L	Glass	Rect	G	Yes	Cavity	Elec	Mag	90	14 $\frac{1}{8}$	14
14NP4-A	12L	Glass	Rect	G; A	Yes	Cavity	Elec	Mag	90	14 $\frac{1}{8}$	14
14QP4	12L	Glass	Rect	G	Yes	Cavity	Elec	Mag	70	16 $\frac{5}{8}$	13 $\frac{1}{2}$
14QP4-A	12L	Glass	Rect	G; A	Yes	Cavity	Elec	Mag	70	16 $\frac{5}{8}$	13 $\frac{1}{2}$
14RP4	12L	Glass	Rect	G	Yes	Cavity	Elec	Mag	90	14 $\frac{1}{8}$	14
14RP4-A	12L	Glass	Rect	G; A	Yes	Cavity	Elec	Mag	90	14 $\frac{1}{8}$	14
14SP4	12L	Glass	Rect	G; A	Yes	Cavity	Elec	Mag	85	14 $\frac{1}{8}$	14
14WP4	12L	Glass	Rect	G; A	Yes	Cavity	Elec	Mag	90	13 $\frac{1}{8}$	14
14ZP4	12L	Glass	Rect	G; A	Yes	Cavity	Elec	Mag	90	13 $\frac{1}{8}$	14
15AP4	12D	Glass	Round	C	No	Ball	Mag	Mag	57	20 $\frac{1}{2}$	15 $\frac{1}{2}$
15CP4	12D	Glass	Round	C	No	Cavity	Mag	Mag	57	20 $\frac{1}{2}$	15 $\frac{1}{2}$
15DP4	12D	Glass	Round	C	No	Ball	Mag	Mag	57	20 $\frac{1}{2}$	15 $\frac{1}{2}$
15DP4-A	12D	Glass	Round	G	No	Ball	Mag	Mag	57	20 $\frac{1}{2}$	15 $\frac{1}{2}$
15EP4	12D	Glass	Round	C	No	Small Cap	Mag	Mag	52	22 $\frac{1}{8}$	15 $\frac{1}{2}$
15GP22	20A	Tricolor Tube (3-gun shadow-mask type; phosphor-dots on glass plate mounted inside tube)			Yes	Flange	Elec	Mag	45	25 $\frac{1}{2}$	14 $\frac{3}{8}$
15HP22	20A	Tricolor Tube (3-gun shadow-mask type; phosphor-dots on face-plate)			Yes	Flange	Elec	Mag	45	25 $\frac{1}{2}$	14 $\frac{3}{8}$
16AP4	12D	Metal	Round	C	Metal	Cone	Mag	Mag	53	22 $\frac{1}{4}$	15 $\frac{3}{8}$
16AP4-A	12D	Metal	Round	G	Metal	Cone	Mag	Mag	53	21 $\frac{1}{2}$	15 $\frac{3}{8}$

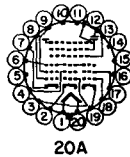
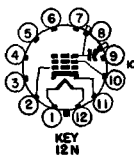
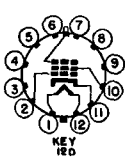

Heater Volts/ Amp	Max Anode Volts	Max Grid 2 Volts	Typical Operating Conditions							Type
			Anode Volts	Grid 2 Volts	Neg Grid 1 Cutoff Volts	RETMA Focus Coil No.	Focus Coil Dist†	Focus Current in ma	Ion Trap Magnet	
6.3/0.6	10,000	380	9,000	250	24 to 62*	—	—	—	Single	14KP4
6.3/0.6	14,000	410	10,000	250	24 to 62*	—	—	—	Single	14KP4-A
6.3/0.6	14,000 $\Delta$ +1,000 -500 $\bullet$	500	12,000 $\Delta$ 150 $\bullet$	300	28 to 72*	—	—	—	Single	14NP4
6.3/0.6	14,000 $\Delta$ +1,000 -500 $\bullet$	500	12,000 $\Delta$ 150 $\bullet$	300	28 to 72*	—	—	—	Single	14NP4-A
6.3/0.6	11,000 $\Delta$ +1,000 -500 $\bullet$	500	9,000 $\Delta$ 100 $\bullet$	250	24 to 64*	—	—	—	Single	14QP4
6.3/0.6	11,000 $\Delta$ +1,000 -500 $\bullet$	500	9,000 $\Delta$ 100 $\bullet$	250	24 to 64*	—	—	—	Single	14QP4-A
6.3/0.6	14,000 $\Delta$ +500 -500 $\bullet$	400	10,000 $\Delta$ 150 $\bullet$	300	26 to 70*	—	—	—	Single	14RP4
6.3/0.6	14,000 $\Delta$ +500 -500 $\bullet$	400	10,000 $\Delta$ 150 $\bullet$	300	26 to 70*	—	—	—	Single	14RP4-A
6.3/0.6	14,000 $\Delta$ +1,000 -500 $\bullet$	500	12,000 $\Delta$ 108 $\bullet$	300	28 to 72*	—	—	—	Single	14SP4
6.3/0.6	14,000 $\Delta$ +1,000 -500 $\bullet$	500	12,000 $\Delta$ 150 $\bullet$	300	28 to 72*	—	—	—	None	14WP4
6.3/0.6	14,000 $\Delta$ +1,000 -500 $\bullet$	500	12,000 $\Delta$ 225 $\bullet$	300	28 to 72*	—	—	—	None	14ZP4
6.3/0.6	15,000	410	12,000	250	24 to 62*	106	3¼	159	None	15AP4
6.3/0.6	15,000	410	12,000	250	24 to 62*	106	3.0	115	Double	15CP4
6.3/0.6	15,000	410	12,000	250	24 to 62*	106	3.0	140	Single	15DP4
6.3/0.6	15,000	410	12,000	250	24 to 62*	106	3	140	Single	15DP4-A
6.3/0.6	10,000	380	10,000	250	24 to 62*	—	—	—	Single	15EP4
6.3/1.8	20,000 $\Delta$ 5,000 $\bullet$	500	20,000 $\Delta$ 3,100 $\bullet$	200	45 to 100 *	Convergence method—Electrostatic. Max convergence voltage 11000. Typical convergence voltage 9350 $\oplus$ .				15GP22
6.3/1.8	20,000 $\Delta$ 5,000 $\bullet$	500	20,000 $\Delta$ 3,100 $\bullet$	240	45 to 100 *	Convergence method—Electrostatic. Max convergence voltage 11000. Typical convergence voltage 9300 $\oplus$ .				15HP22
6.3/0.6	14,000	410	12,000	300	28 to 72*	109	3.0	80	Double	16AP4
6.3/0.6	14,000	410	13,000	300	28 to 72*	109	3½ <sub>16</sub>	107	Double	16AP4-A

A—Aluminized screen to increase light output.

C—Clear (untinted) faceplate.

F—Frosted faceplate surface to reduce reflection.

G—Grey (filter) faceplate.

¶ Diagonal measurement for rectangular tubes.

‡ Distance between yoke reference line and center of focus-coil air gap; in inches.

△ Accelerator anode and collector.

● Anode No. 1 (Focus) under typical operating conditions center value of voltage for focus is shown. Voltage should be adjustable about this value.

† For visual extinction of undeflected focused spot.

◆ Deflection factor.

● Designates projection type.

\* For visual extinction of focused raster.

□ Automatic electrostatic focus. No external focus connection required.

▲ Intensifier No. 3 Anode.

‡ Accelerator No. 2 Anode.

⊕ Center value of voltage for convergence is shown. Modulation should be applied to improve over-all convergence.

⊞ With cylindrical contour.

Type	Base Connections	Construction	Face-plate Shape	Face-plate Finish	Ext'l Conductive Coating	Anode Contact	Focus Method	Defl Method	Defl Angle Degrees	Nom Over-all Length Inches	Nom Bulb Diam Inches
16ABP4	12P	Glass	Rect	G	Yes	Cavity	Elec □	Mag	70	18 3/4	16 1/8
16ACP4	12P	Glass	Round	G	Yes	Cavity	Elec □	Mag	60	20 7/8	16 1/8
16AEP4	12L	Glass	Rect	G	Yes	Cavity	Elec	Mag	70	18 3/4	16 1/8
16AFP4	12L	Glass	Rect	G; A	No	Cavity	Elec	Mag	70	19 1/8	16 1/8
16CP4	12D	Glass	Round	C	No	Cavity	Mag	Mag	52	21 1/2	15 3/8
16DP4	12D	Glass	Round	C	No	Cavity	Mag	Mag	60	20 3/4	15 7/8
16DP4-A	12D	Glass	Round	G	No	Cavity	Mag	Mag	60	20 3/4	15 7/8
16EP4	12D	Metal	Round	C	Metal	Cone	Mag	Mag	60	19 5/8	15 7/8
16EP4-A	12D	Metal	Round	G	Metal	Cone	Mag	Mag	60	19 5/8	15 7/8
16EP4-B	12D	Metal	Round	G; F	Metal	Cone	Mag	Mag	60	19 5/8	15 7/8
16FP4	12D	Glass	Round	C	No	Ball	Mag	Mag	62	20 1/4	16 1/8
16GP4	12D	Metal	Round	G	Metal	Cone	Mag	Mag	70	17 1/4	15 7/8
16GP4-A	12D	Metal	Round	C	Metal	Cone	Mag	Mag	70	17 1/4	15 7/8
16GP4-B	12D	Metal	Round	G; F	Metal	Cone	Mag	Mag	70	17 1/4	15 7/8
16GP4-C	12D	Metal	Round	C; F	Metal	Cone	Mag	Mag	70	17 1/4	15 7/8
16HP4	12N	Glass	Round	C	Yes	Cavity	Mag	Mag	60	21 1/4	15 7/8
16HP4-A	12N	Glass	Round	G	Yes	Cavity	Mag	Mag	60	21 1/4	15 7/8
16JP4	12N	Glass	Round	C	Yes	Cavity	Mag	Mag	60	20 3/4	16 1/8
16JP4-A	12N	Glass	Round	G	Yes	Cavity	Mag	Mag	60	20 3/4	16 1/8
16KP4	12N	Glass	Rect	G	Yes	Cavity	Mag	Mag	70	18 3/4	16 1/8
16KP4-A	12N	Glass	Rect	G; A	Yes	Cavity	Mag	Mag	70	18 3/4	16 1/8
16LP4	12N	Glass	Round	C	Yes	Cavity	Mag	Mag	52	22 1/4	15 7/8
16LP4-A	12N	Glass	Round	G	Yes	Cavity	Mag	Mag	52	22 1/4	15 7/8
16MP4	12N	Glass	Round	C	Yes	Cavity	Mag	Mag	60	21 3/4	15 7/8
16MP4-A	12N	Glass	Round	G	Yes	Cavity	Mag	Mag	60	21 3/4	15 7/8
16QP4	12D	Glass	Rect	G	No	Cavity	Mag	Mag	70	19 1/8	16
16RP4	12N	Glass	Rect	G	Yes	Cavity	Mag	Mag	70	18 3/4	16 1/8
16RP4-A	12N	Glass	Rect	G; A	Yes	Cavity	Mag	Mag	70	18 3/4	16 1/8
16SP4	12N	Glass	Round	C	Yes	Cavity	Mag	Mag	70	17 5/8	15 7/8
16SP4-A	12N	Glass	Round	G	Yes	Cavity	Mag	Mag	70	17 5/8	15 7/8
16TP4	12N	Glass	Rect	G	Yes	Cavity	Mag	Mag	70	18 1/8	16 1/8

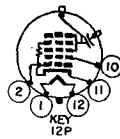
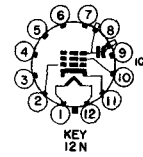
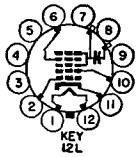

Heater Volts/ Amp	Max Anode Volts	Max Grid 2 Volts	Typical Operating Conditions							Type
			Anode Volts	Grid 2 Volts	Neg Grid 1 Cutoff Volts	RETMA Focus Coil No.	Focus Coil Dist†	Focus Current in ma	Ion Trap Magnet	
6.3/0.6	16,000	500	14,000	300	28 to 72*	—	—	—	Single	16ABP4
6.3/0.6	14,000	410	13,000	250	33 to 68†	—	—	—	Double	16ACP4
6.3/0.6	16,000 +1,000, -500●	410	14,000△ 126●	300	28 to 72*	—	—	—	Single	16AEP4
6.3/0.6	16,000 +1,000, -500●	410	12,000△ 108●	250	24 to 62*	—	—	—	—	16AFP4
6.3/0.6	15,000	410	12,000	250	24 to 62*	106	3¼	110	Double	16CP4
6.3/0.6	15,000	410	12,000	250	24 to 62*	106	3¼	115	Double	16DP4
6.3/0.6	15,000	410	12,000	250	24 to 62*	109	3¼	115	Double	16DP4-A
6.3/0.6	14,000	410	12,000	300	28 to 72*	109	2¾	105	Double	16EP4
6.3/0.6	14,000	410	12,000	300	28 to 72*	109	2¾	105	Double	16EP4-A
6.3/0.6	14,000	410	12,000	300	28 to 72*	109	3.0	105	Single	16EP4-B
6.3/0.6	16,000	410	13,000	250	24 to 62*	106	3.0	146	Single	16FP4
6.3/0.6	14,000	410	13,000	300	28 to 72*	109	3½	108	Single	16GP4
6.3/0.6	14,000	410	13,000	250	24 to 62*	109	3½	108	Single	16GP4-A
6.3/0.6	14,000	410	13,000	250	24 to 62*	109	3½	108	Single	16GP4-B
6.3/0.6	14,000	410	12,000	300	28 to 72*	109	3.0	100	Single	16GP4-C
6.3/0.6	14,000	410	12,000	300	28 to 72*	106	3¼	110	Double	16HP4
6.3/0.6	14,000	410	12,000	300	28 to 72*	106	3¼	110	Double	16HP4-A
6.3/0.6	14,000	410	11,000	250	24 to 62*	106	—	115	Double	16JP4
6.3/0.6	14,000	410	11,000	250	24 to 62*	106	—	115	Double	16JP4-A
6.3/0.6	16,000	410	14,000	300	28 to 72*	109	3¾	108	Single	16KP4
6.3/0.6	16,000	410	14,000	300	28 to 72*	109	3¾	108	Single	16KP4-A
6.3/0.6	14,000	410	12,000	300	28 to 72*	106	3¼	110	Double	16LP4
6.3/0.6	14,000	410	12,000	300	28 to 72*	106	3¼	110	Double	16LP4-A
6.3/0.6	14,000	410	12,000	300	28 to 72*	106	3¼	110	Double	16MP4
6.3/0.6	14,000	410	12,000	300	28 to 72*	106	3¼	110	Double	16MP4-A
6.3/0.6	16,000	410	14,000	250	24 to 62*	106	—	150	Double	16QP4
6.3/0.6	16,000	410	12,000	300	28 to 72*	109	3½	100	Single	16RP4
6.3/0.6	16,000	410	12,000	300	28 to 72*	109	3½	100	Single	16RP4-A
6.3/0.6	14,000	410	12,000	300	28 to 72*	106	3¼	110	Double	16SP4
6.3/0.6	14,000	410	12,000	300	28 to 72*	106	3¼	110	Double	16SP4-A
6.3/0.6	14,000	410	12,000	300	28 to 72*	109	3½	99	Single	16TP4

A—Aluminized screen to increase light output.

C—Clear (untinted) faceplate.

F—Frosted faceplate surface to reduce reflection.

G—Grey (filter) faceplate.

¶ Diagonal measurement for rectangular tubes.

‡ Distance between yoke reference line and center of focus-coil air gap; in inches.

△Accelerator anode and collector.

●Anode No. 1 (Focus); under typical operating conditions center value of voltage for focus is shown. Voltage should be adjustable about this value.

† For visual extinction of undeflected focused spot.

◆Deflection factor.

● Designates projection type.

\* For visual extinction of focused raster.

□Automatic electrostatic focus. No external focus connection required.

▲Intensifier No. 3 Anode.

‡ Accelerator No. 2 Anode.

⊕Center value of voltage for convergence is shown. Modulation should be applied to improve over-all convergence.

‡ With cylindrical contour.

Type	Base Connections	Construction	Face-plate Shape	Face-plate Finish	Ext'l Conductive Coating	Anode Contact	Focus Method	Defl Method	Defl Angle Degrees	Nom Over-all Length Inches	Nom Bulb Diam Inches
16UP4	12D	Glass	Rect	G	No	Cavity	Mag	Mag	70	18 $\frac{1}{8}$	16 $\frac{1}{8}$
16VP4	12D	Glass	Round	G	No	Cavity	Mag	Mag	70	17 $\frac{1}{8}$	15 $\frac{1}{8}$
16WP4	12D	Glass	Round	G	No	Cavity	Mag	Mag	70	17 $\frac{3}{8}$	15 $\frac{1}{8}$
16WP4-A	12N	Glass	Round	G	Yes	Cavity	Mag	Mag	70	17 $\frac{3}{8}$	15 $\frac{1}{8}$
16XP4	12D	Glass	Rect	G	No	Cavity	Mag	Mag	70	18 $\frac{3}{8}$	16 $\frac{1}{8}$
16YP4	12N	Glass	Round	G	Yes	Cavity	Mag	Mag	70	17 $\frac{1}{8}$	15 $\frac{1}{8}$
16ZP4	12N	Glass	Round	G	Yes	Cavity	Mag	Mag	52	22 $\frac{1}{4}$	15 $\frac{1}{8}$
17AP4	12N	Glass	Rect	G	Yes	Cavity	Mag	Mag	70	18 $\frac{5}{8}$	16 $\frac{1}{8}$
17ASP4	12N	Glass	Rect	C	Yes	Small Cap	Mag	Mag	70	19 $\frac{1}{2}$	16 $\frac{1}{8}$
17ATP4	12L	Glass	Rect	G	Yes	Cavity	Elec	Mag	90	16	16 $\frac{1}{8}$
17ATP4-A	12L	Glass	Rect	G; A	Yes	Cavity	Elec	Mag	90	16	16 $\frac{1}{8}$
17AVP4	12L	Glass	Rect	G	Yes	Cavity	Elec	Mag	90	15 $\frac{5}{8}$	16 $\frac{1}{8}$
17AVP4-A	12L	Glass	Rect	G; A	Yes	Cavity	Elec	Mag	90	15 $\frac{5}{8}$	16 $\frac{1}{8}$
17BP4	12D	Glass	Rect	G	No	Cavity	Mag	Mag	70	19 $\frac{1}{8}$	16 $\frac{1}{8}$
17BP4-A	12N	Glass	Rect	G	Yes	Cavity	Mag	Mag	70	19 $\frac{1}{8}$	16 $\frac{1}{8}$
17BP4-B	12N	Glass	Rect	G; A	Yes	Cavity	Mag	Mag	70	19 $\frac{1}{8}$	16 $\frac{1}{8}$
17BP4-C	12N	Glass	Rect	G; F	Yes	Cavity	Mag	Mag	70	19 $\frac{1}{8}$	16 $\frac{1}{8}$
17BJP4	12L	Glass	Rect	G; A	Yes	Cavity	Elec	Mag	90	14 $\frac{1}{8}$	16 $\frac{1}{8}$
17CP4	12D	Metal	Rect	G; F	Metal	Cone	Mag	Mag	70	18 $\frac{1}{2}$	16 $\frac{1}{8}$
17CP4-A	12D	Metal	Rect	C	Metal	Cone	Mag	Mag	70	18 $\frac{1}{2}$	16 $\frac{1}{8}$
17FP4	12L	Glass	Rect	G	Yes	Cavity	Elec	Mag	70	19 $\frac{1}{8}$	16 $\frac{1}{8}$
17FP4-A	12L	Glass	Rect	G	Yes	Cavity	Elec	Mag	70	19 $\frac{1}{8}$	16 $\frac{1}{8}$
17GP4	12M	Metal	Rect	G; F	Metal	Cone	Elec	Mag	70	18 $\frac{1}{8}$	16 $\frac{1}{8}$
17HP4	12L	Glass	Rect	G	Yes	Cavity	Elec	Mag	70	19 $\frac{1}{8}$	16 $\frac{1}{8}$
17HP4-A	12L	Glass	Rect	G; F	Yes	Cavity	Elec	Mag	70	19 $\frac{1}{8}$	16 $\frac{1}{8}$

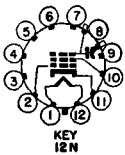
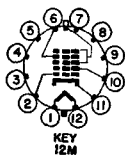
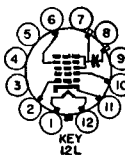
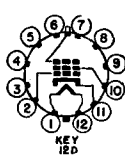



Heater Volts/ Amp	Max Anode Volts	Max Grid 2 Volts	Typical Operating Conditions							Type
			Anode Volts	Grid 2 Volts	Neg Grid 1 Cutoff Volts	RETMA Focus Coil No.	Focus Coil Dist†	Focus Current in ma	Ion Trap Magnet	
6.3/0.6	15,000	410	12,000	300	28 to 72*	109	3.0	100	Single	16UP4
6.3/0.6	15,000	410	12,000	250	24 to 62*	109	3.0	110	Single	16VP4
6.3/0.6	15,000	410	12,000	250	24 to 62*	109	3.0	110	Double	16WP4
6.3/0.6	16,000	410	12,000	250	24 to 62*	109	3¼	110	Double	16WP4-A
6.3/0.6	15,000	410	12,000	250	24 to 62*	109	3.0	100	Double	16XP4
6.3/0.6	14,000	410	12,000	300	28 to 72*	109	3¼	100	Single	16YP4
6.3/0.6	16,000	410	12,000	300	28 to 72*	109	3¼	110	Double	16ZP4
6.3/0.6	16,000	410	12,000	300	28 to 72*	109	3.0	100	Single	17AP4
6.3/0.6	14,000	410	12,000	250	24 to 62*	—	—	—	Single	17ASP4
6.3/0.6	16,000 Δ; +1,000, -500 ●	500	14,000 Δ 126 ●	300	28 to 72*	—	—	—	Single	17ATP4
6.3/0.6	16,000 Δ; +1,000, -500 ●	500	14,000 Δ 126 ●	300	28 to 72*	—	—	—	Single	17ATP4-A
6.3/0.6	16,000 Δ; +1,000, -500 ●	500	12,000 Δ 108 ●	300	28 to 72*	—	—	—	Single	17AVP4
6.3/0.6	16,000 Δ; +1,000, -500 ●	500	12,000 Δ 108 ●	300	28 to 72*	—	—	—	Single	17AVP4-A
6.3/0.6	16,000	410	12,000	300	28 to 72*	109	3.0	100	Single	17BP4
6.3/0.6	16,000	410	14,000	300	28 to 72*	109	3¼	115	Single	17BP4-A
6.3/0.6	16,000	410	14,000	300	28 to 72*	109	3¼	115	Single	17BP4-B
6.3/0.6	16,000	410	14,000	250	24 to 62*	109	3¼	115	Single	17BP4-C
6.3/0.6	16,000 Δ; +1,000, -500 ●	500	12,000 Δ 108 ●	300	28 to 72*	—	—	—	None	17BJP4
6.3/0.6	16,000	410	14,000	300	28 to 72*	109	3.0	104	Single	17CP4
6.3/0.6	16,000	410	14,000	300	28 to 72*	109	3.0	104	Single	17CP4-A
6.3/0.6	18,000 Δ; 5,000 ●	410	16,000 Δ; 3,150 ●	300	28 to 72*	—	—	—	Single	17FP4
6.3/0.6	18,000 Δ; 5,000 ●	500	16,000 Δ; 3,150 ●	300	28 to 72*	—	—	—	Single	17FP4-A
6.3/0.6	16,000 Δ; 5,000 ●	500	14,000 Δ; 2,800 ●	300	28 to 72*	—	—	—	Single	17GP4
6.3/0.6	16,000 +1,000, -500 ●	500	14,000 126 ●	300	28 to 72*	—	—	—	Single	17HP4
6.3/0.6	16,000 +1,000, -500 ●	500	14,000 Δ 126 ●	300	28 to 72*	—	—	—	Single	17HP4-A

A—Aluminized screen to increase light output.

C—Clear (untinted) faceplate.

F—Frosted faceplate surface to reduce reflection.

G—Grey (filter) faceplate.

¶ Diagonal measurement for rectangular tubes.

‡ Distance between yoke reference line and center of focus-coil air gap; in inches.

Δ Accelerator anode and collector.

● Anode No. 1 (Focus); under typical operating conditions center value of voltage for focus is shown. Voltage should be adjustable about this value.

† For visual extinction of undeflected focused spot.

⊙ Deflection factor.

● Designates projection type.

\* For visual extinction of focused raster.

□ Automatic electrostatic focus. No external focus connection required.

▲ Intensifier No. 3 Anode.

‡ Accelerator No. 2 Anode.

⊕ Center value of voltage for convergence is shown. Modulation should be applied to improve over-all convergence.

⊞ With cylindrical contour.

Type	Base Connections	Construction	Face-plate Shape	Face-plate Finish	Ext'l Conductive Coating	Anode Contact	Focus Method	Defl Method	Defl Angle Degrees	Nom Over-all Length Inches	Nom Bulb Diam Inches
17HP4-B	12L	Glass	Rect	G; A	Yes	Cavity	Elec	Mag	70	19 <sup>1</sup> / <sub>16</sub>	16 <sup>5</sup> / <sub>8</sub>
17JP4	12N	Glass	Rect	G	Yes	Cavity	Mag	Mag	70	19 <sup>1</sup> / <sub>16</sub>	16 <sup>5</sup> / <sub>8</sub>
17KP4	12P	Glass	Rect	G	Yes	Cavity	Elec □	Mag	70	19 <sup>1</sup> / <sub>16</sub>	16 <sup>5</sup> / <sub>8</sub>
17LP4	12L	Glass	Rect	G	Yes	Cavity	Elec	Mag	70	19 <sup>1</sup> / <sub>16</sub>	16 <sup>5</sup> / <sub>8</sub>
17LP4-A	12L	Glass	Rect	G; A	Yes	Cavity	Elec	Mag	70	19 <sup>1</sup> / <sub>16</sub>	16 <sup>5</sup> / <sub>8</sub>
17QP4	12N	Glass	Rect	G	Yes	Cavity	Mag	Mag	70	19 <sup>1</sup> / <sub>16</sub>	16 <sup>5</sup> / <sub>8</sub>
17QP4-A	12N	Glass	Rect	G; A	Yes	Cavity	Mag	Mag	70	19 <sup>1</sup> / <sub>16</sub>	16 <sup>5</sup> / <sub>8</sub>
17RP4	12L	Glass	Rect	G	Yes	Cavity	Elec	Mag	70	19 <sup>1</sup> / <sub>16</sub>	16 <sup>5</sup> / <sub>8</sub>
17RP4-C	12L	Glass	Rect	G; A	Yes	Cavity	Elec	Mag	70	19 <sup>1</sup> / <sub>16</sub>	16 <sup>5</sup> / <sub>8</sub>
17SP4	12P	Glass	Rect	G	Yes	Cavity	Elec □	Mag	70	19 <sup>1</sup> / <sub>16</sub>	16 <sup>5</sup> / <sub>8</sub>
17TP4	12M	Metal	Rect	G; F	Metal	Cone	Elec	Mag	70	18 <sup>1</sup> / <sub>16</sub>	16 <sup>1</sup> / <sub>16</sub>
17UP4	12N	Glass	Rect	G	Yes	Cavity	Mag	Mag	70	19 <sup>1</sup> / <sub>16</sub>	16 <sup>5</sup> / <sub>8</sub>
17VP4	12L	Glass	Rect	G	Yes	Cavity	Elec	Mag	70	19 <sup>1</sup> / <sub>16</sub>	16 <sup>5</sup> / <sub>8</sub>
17VP4-B	12L	Glass	Rect	G; A	Yes	Cavity	Elec	Mag	70	19 <sup>1</sup> / <sub>16</sub>	16 <sup>5</sup> / <sub>8</sub>
17YP4	12N	Glass	Rect	G	Yes	Cavity	Mag	Mag	70	19 <sup>1</sup> / <sub>16</sub>	16 <sup>5</sup> / <sub>8</sub>
19AP4	12D	Metal	Round	C	Metal	Cone	Mag	Mag	66	21 <sup>1</sup> / <sub>2</sub>	18 <sup>5</sup> / <sub>8</sub>
19AP4-A	12D	Metal	Round	G	Metal	Cone	Mag	Mag	66	21 <sup>1</sup> / <sub>2</sub>	18 <sup>5</sup> / <sub>8</sub>
19AP4-B	12D	Metal	Round	G; F	Metal	Cone	Mag	Mag	66	21 <sup>1</sup> / <sub>2</sub>	18 <sup>5</sup> / <sub>8</sub>
19AP4-C	12D	Metal	Round	G; A	No	Cone	Mag	Mag	66	21 <sup>1</sup> / <sub>2</sub>	18 <sup>5</sup> / <sub>8</sub>
19AP4-D	12D	Metal	Round	C; F	Metal	Cone	Mag	Mag	66	21 <sup>1</sup> / <sub>2</sub>	18 <sup>5</sup> / <sub>8</sub>
19DP4	12N	Glass	Round	C	Yes	Cavity	Mag	Mag	66	21 <sup>1</sup> / <sub>2</sub>	18 <sup>5</sup> / <sub>8</sub>
19DP4-A	12N	Glass	Round	G	Yes	Cavity	Mag	Mag	66	21 <sup>1</sup> / <sub>2</sub>	18 <sup>5</sup> / <sub>8</sub>
19EP4	12D	Glass	Rect	G	Yes	Cavity	Mag	Mag	70	21 <sup>1</sup> / <sub>2</sub>	18 <sup>5</sup> / <sub>8</sub>
19FP4	12D	Glass	Round	G	No	Cavity	Mag	Mag	66	22	18 <sup>5</sup> / <sub>8</sub>
19GP4	12D	Glass	Round	G	No	Cavity	Mag	Mag	66	21 <sup>1</sup> / <sub>4</sub>	18 <sup>5</sup> / <sub>8</sub>
19JP4	12D	Glass	Rect	G	No	Cavity	Mag	Mag	70	20 <sup>1</sup> / <sub>16</sub>	18 <sup>5</sup> / <sub>8</sub>

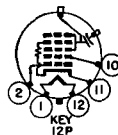
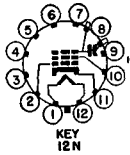
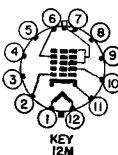
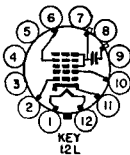
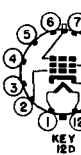

Heater Volts/ Amp	Max Anode Volts	Max Grid 2 Volts	Typical Operating Conditions							Type
			Anode Volts	Grid 2 Volts	Neg Grid 1 Cutoff Volts	RETMA Focus Coil No.	Focus Coil Dist†	Focus Current in ma	Ion Trap Magnet	
6.3/0.6	16,000 $\Delta$ +1,000, -500 $\bullet$	500	14,000 $\Delta$ 126 $\bullet$	300	28 to 72*	—	—	—	Single	17HP4-B
6.3/0.6	18,000	410	16,000	300	28 to 72*	109	—	100	Single	17JP4
6.3/0.6	16,000	500	12,000	300	28 to 72*	—	—	—	Single	17KP4
6.3/0.6	16,000 $\Delta$ +1,000, -500 $\bullet$	500	14,000 $\Delta$ 126 $\bullet$	300	28 to 72*	—	—	—	Single	17LP4
6.3/0.6	16,000 $\Delta$ +1,000, -500 $\bullet$	500	14,000 $\Delta$ 126 $\bullet$	300	28 to 72*	—	—	—	Single	17LP4-A
6.3/0.6	16,000	500	14,000	300	28 to 72*	109	3 $\frac{3}{4}$	115	Single	17QP4
6.3/0.6	18,000	500	14,000	300	28 to 72*	109	3	95	Single	17QP4-A
6.3/0.6	16,000 $\Delta$ +1,000, -500 $\bullet$	500	14,000 $\Delta$ 126 $\bullet$	300	28 to 72*	—	—	—	Single	17RP4
6.3/0.6	16,000 $\Delta$ +1,000, -500 $\bullet$	500	14,000 $\Delta$ 126 $\bullet$	300	28 to 72*	—	—	—	Single	17RP4-C
6.3/0.6	14,000	410	12,000	250	33 to 66†	—	—	—	Single	17SP4
6.3/0.6	16,000 $\Delta$ 500 $\bullet$	500	14,000 $\Delta$ 126 $\bullet$	300	28 to 72*	—	—	—	Single	17TP4
6.3/0.6	14,000	410	12,000	250	33 to 66†	109	3.25	110	Single	17UP4
6.3/0.6	16,000 $\Delta$ +1,000, -500 $\bullet$	500	14,000 $\Delta$ 126 $\bullet$	300	28 to 72*	—	—	—	Single	17VP4
6.3/0.6	16,000 $\Delta$ +1,000, -500 $\bullet$	500	14,000 $\Delta$ 126 $\bullet$	300	28 to 72*	—	—	—	Single	17VP4-B
6.3/0.6	18,000	500	16,000	300	28 to 72*	109	—	100	Single	17YP4
6.3/0.6	19,000	410	15,000	300	28 to 72*	109	3 $\frac{3}{8}$	115	Single	19AP4
6.3/0.6	19,000	410	15,000	300	28 to 72*	109	3 $\frac{3}{8}$	115	Single	19AP4-A
6.3/0.6	19,000	410	15,000	300	28 to 72*	109	3 $\frac{3}{8}$	115	Single	19AP4-B
6.3/0.6	19,000	410	12,000	300	28 to 72*	106	3	115	Single	19AP4-C
6.3/0.6	19,000	410	14,000	300	28 to 72*	106	3.0	145	Single	19AP4-D
6.3/0.6	17,000	410	13,000	250	26 to 63†	106	3 $\frac{1}{4}$	146	Single	19DP4
6.3/0.6	17,000	410	13,000	250	26 to 63†	106	3 $\frac{1}{4}$	146	Single	19DP4-A
6.3/0.6	19,000	410	13,000	250	26 to 63†	109	3 $\frac{1}{4}$	146	Double	19EP4
6.3/0.6	19,000	410	13,000	250	24 to 62*	109	3.0	115	Double	19FP4
6.3/0.6	19,000	410	13,000	250	24 to 62*	109	3.0	120	Single	19GP4
6.3/0.6	18,000	410	12,000	300	28 to 72*	109	3.0	95	Single	19JP4

A—Aluminized screen to increase light output.

C—Clear (untinted) faceplate.

F—Frosted faceplate surface to reduce reflection.

G—Grey (filter) faceplate.

¶ Diagonal measurement for rectangular tubes.

‡ Distance between yoke reference line and center of focus-coil air gap; in inches.

$\Delta$  Accelerator anode and collector.

$\bullet$  Anode No. 1 (Focus); under typical operating conditions center value of voltage for focus is shown. Voltage should be adjustable about this value.

† For visual extinction of undeflected focused spot.

$\diamond$  Deflection factor.

$\ast$  Designates projection type.

$\bullet$  For visual extinction of focused raster.

$\square$  Automatic electrostatic focus. No external focus connection required.

$\blacktriangle$  Intensifier No. 3 Anode.

$\ddagger$  Accelerator No. 2 Anode.

$\oplus$  Center value of voltage for convergence is shown. Modulation should be applied to improve over-all convergence.

$\boxplus$  With cylindrical contour.

Type	Base Connections	Construction	Face-plate Shape	Face-plate Finish	Ext'l Conductive Coating	Anode Contact	Focus Method	Defl Method	Defl Angle Degrees	Nom Over-all Length Inches	Nom Bulb Diam Inches
19QP4	12L	Glass	Rect	G	Yes	Cavity	Elec	Mag	70	21 1/4	18 3/4
19TP22	20A	Tricolor Tube (3-gun shadow-mask type; phosphor-dots on faceplate)			Yes	Flange	Elec	Mag	60	24 3/4	19 1/4
19VP22	14W	Tricolor Tube (3-gun shadow-mask type; phosphor-dots on faceplate)			Yes	Flange	Elec	Mag	62	26 1/4	19 1/4
20AP4	12A	Glass	Round	C	No	Base	Elec	Elec	—	27 3/4	20
20BP4	12D	Glass	Round	C	No	Cap	Mag	Mag	54	28	20
20CP4	12D	Glass	Rect	G	No	Cavity	Mag	Mag	70	21 1/4	20 1/4
20CP4-A	12N	Glass	Rect	G	Yes	Cavity	Mag	Mag	70	21 1/4	20 1/4
20CP4-B	12D	Glass	Rect	G; A	No	Cavity	Mag	Mag	70	21 1/4	20 1/4
20CP4-C	12D	Glass	Rect	G; F	No	Cavity	Mag	Mag	70	21 1/4	20 1/4
20CP4-D	12N	Glass	Rect	G; A	Yes	Cavity	Mag	Mag	70	21 1/4	20 1/4
20DP4	12D	Glass	Rect	G	No	Cavity	Mag	Mag	70	21 3/4	20 1/4
20DP4-A	12N	Glass	Rect	G	Yes	Cavity	Mag	Mag	70	21 3/4	20 1/4
20DP4-B	12D	Glass	Rect	G; A	No	Cavity	Mag	Mag	70	21 3/4	20 1/4
20DP4-C	12N	Glass	Rect	G; A	Yes	Cavity	Mag	Mag	70	21 3/4	20 1/4
20FP4	12M	Glass	Rect	G	No	Cavity	Elec	Mag	70	21 3/4	20 1/4
20GP4	12L	Glass	Rect	G	Yes	Cavity	Elec	Mag	70	21 3/4	20 1/4
20HP4	12M	Glass	Rect	G	No	Cavity	Elec	Mag	70	21 3/4	20 1/4
20HP4-A	12L	Glass	Rect	G	Yes	Cavity	Elec	Mag	70	21 3/4	20 1/4
20HP4-B	12L	Glass	Rect	G; F	No	Cavity	Elec	Mag	70	21 3/4	20 1/4
20HP4-C	12M	Glass	Rect	G; A	No	Cavity	Elec	Mag	70	21 3/4	20 1/4
20HP4-D	12L	Glass	Rect	G; A	Yes	Cavity	Elec	Mag	70	21 3/4	20 1/4
20JP4	12P	Glass	Rect	G	Yes	Cavity	Elec	Mag	70	21 3/4	20 1/4
20LP4	12L	Glass	Rect	G	Yes	Cavity	Elec	Mag	70	21 3/4	20 1/4

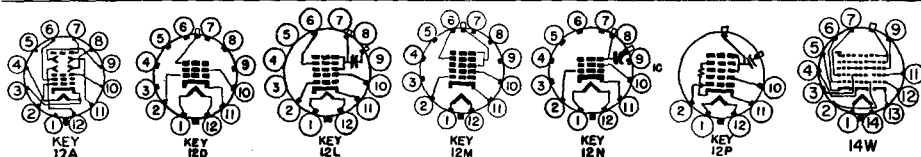

Heater Volts/ Amp	Max Anode Volts	Max Grid 2 Volts	Typical Operating Conditions							Type
			Anode Volts	Grid 2 Volts	Neg Grid 1 Cutoff Volts	RETMA Focus Coil No.	Focus Coil Dist†	Focus Current in ma	Ion Trap Magnet	
6.3/0.6	18,000 $\Delta$ 500 $\bullet$	410	12,000 $\Delta$ 150 $\bullet$	300	28 to 72*	—	—	—	Single	19QP4
6.3/1.8	22,000 $\Delta$ 4,000 $\bullet$	500	20,000 $\Delta$ 2,600 $\bullet$	200	42 to 78*	Convergence method—Electrostatic. Max convergence voltage 12000. Typical convergence voltage 9350 $\oplus$ .			19TP22	
6.3/1.8	27,000 $\Delta$ 9,000 $\bullet$	500	25,000 $\Delta$ 7,250 $\bullet$	200	45 to 100*	Convergence method—Magnetic.			19VP22	
2.5/2.1	8,000 $\Delta$ 4,000 $\bullet$	1800 $\bullet$	8,000 $\Delta$ 4,000 $\bullet$	1000 $\bullet$	40 to 120 $\dagger$	D1-D2 $\blacklozenge$ = 88 to 132 volts/inch D3-D4 $\blacklozenge$ = 88 to 132 volts/inch			20AP4	
6.3/0.6	16,500	750	15,000	250	24 to 62*	106	3.0	135	None	20BP4
6.3/0.6	18,000	410	15,000	300	28 to 72*	109	3 $\frac{1}{2}$	106	Single	20CP4
6.3/0.6	18,000	410	15,000	300	28 to 72*	109	3 $\frac{1}{2}$	106	Single	20CP4-A
6.3/0.6	18,000	410	16,000	300	28 to 72*	109	3	110	Single	20CP4-B
6.3/0.6	18,000	410	15,000	300	28 to 72*	109	3 $\frac{1}{2}$	106	Single	20CP4-C
6.3/0.6	18,000	410	16,000	300	28 to 72*	109	3.0	110	Single	20CP4-D
6.3/0.6	18,000	410	12,000	300	28 to 72*	109	3.0	95	Single	20DP4
6.3/0.6	18,000	410	12,000	300	28 to 72*	109	3.0	95	Single	20DP4-A
6.3/0.6	18,000	410	16,000	300	28 to 72*	109	3.0	95	Single	20DP4-B
6.3/0.6	18,000	410	16,000	300	28 to 72*	109	3.0	95	Single	20DP4-C
6.3/0.6	18,000 $\Delta$ 5,000 $\bullet$	410	12,000 $\Delta$ 2,750 $\bullet$	300	28 to 72*	—	—	—	Single	20FP4
6.3/0.6	18,000 $\Delta$ 5,000 $\bullet$	500	16,000 $\Delta$ 3,750 $\bullet$	300	28 to 72*	—	—	—	Single	20GP4
6.3/0.6	16,000 $\Delta$ +1,000, -500 $\bullet$	500	14,000 $\Delta$ 126 $\bullet$	300	28 to 72*	—	—	—	Single	20HP4
6.3/0.6	16,000 $\Delta$ +1,000, -500 $\bullet$	500	14,000 $\Delta$ 126 $\bullet$	300	28 to 72*	—	—	—	Single	20HP4-A
6.3/0.6	16,000 $\Delta$ +1,000, -500 $\bullet$	500	14,000 $\Delta$ 126 $\bullet$	300	28 to 72*	—	—	—	Single	20HP4-B
6.3/0.6	16,000 $\Delta$ +1,000, -500 $\bullet$	500	14,000 $\Delta$ 126 $\bullet$	300	28 to 72*	—	—	—	Single	20HP4-C
6.3/0.6	16,000 $\Delta$ +1,000, -500 $\bullet$	500	14,000 $\Delta$ 126 $\bullet$	300	28 to 72*	—	—	—	Single	20HP4-D
6.3/0.6	18000	500	12,000	300	28 to 72*	—	—	—	Single	20JP4
6.3/0.6	16,000 $\Delta$ +1,000, -500 $\bullet$	500	14,000 $\Delta$ 126 $\bullet$	300	28 to 72*	—	—	—	Single	20LP4

A—Aluminized screen to increase light output.

C—Clear (untinted) faceplate.

F—Frosted faceplate surface to reduce reflection.

G—Grey (filter) faceplate.

¶ Diagonal measurement for rectangular tubes.

† Distance between yoke reference line and center of focus-coil air gap; in inches.

$\Delta$  Accelerator anode and collector.

$\bullet$  Anode No. 1 (Focus); under typical operating conditions center value of voltage for focus is shown. Voltage should be adjustable about this value.

† For visual extinction of undeflected focused spot.

$\blacklozenge$  Deflection factor.

$\bullet$  Designates projection type.

\* For visual extinction of focused raster.

$\square$  Automatic electrostatic focus. No external focus connection required.

$\blacktriangle$  Intensifier No. 3 Anode.

$\blacktriangledown$  Accelerator No. 2 Anode.

$\oplus$  Center value of voltage for convergence is shown. Modulation should be applied to improve over-all convergence.

$\text{⌘}$  With cylindrical contour.

Type	Base Connections	Construction	Face-plate Shape	Face-plate Finish	Ext'l Con-ductive Coating	Anode Contact	Focus Method	Defl Method	Defl Angle Degrees	Nom Over-all Length Inches	Nom Bulb Diam Inches
20MP4	12L	Glass	Rect	G	Yes	Cavity	Elec	Mag	70	21 3/4	20 1/2
21AP4	12D	Metal	Rect	G; F	Metal	Cone	Mag	Mag	70	22 5/8	20 3/4
21ACP4	12N	Glass	Rect	G	Yes	Cavity	Mag	Mag	90	20	21 3/8
21ACP4-A	12N	Glass	Rect	G; A	Yes	Cavity	Mag	Mag	90	20	21 3/8
21AFP4	12M	Glass	Rect	G	No	Cavity	Elec	Mag	70	23	21 1/2
21ALP4	12L	Glass	Rect	G	Yes	Cavity	Elec	Mag	90	20	21 3/8
21ALP4-A	12L	Glass	Rect	G; A	Yes	Cavity	Elec	Mag	90	20	21 3/8
21ALP4-B	12L	Glass	Rect	G; A	Yes	Cavity	Elec	Mag	90	20	21 3/8
21AMP4	12N	Glass	Rect	G	Yes	Cavity	Mag	Mag	90	20	21 3/8
21AMP4-A	12N	Glass	Rect	G; A	Yes	Cavity	Mag	Mag	90	20	21 3/8
21AMP23-A	12N	Glass	Rect	G; A	Yes	Cavity	Mag	Mag	90	20	21 3/8
21ANP4	12M	Glass	Rect	G	Yes	Cavity	Elec	Mag	90	20	21 3/8
21ANP4-A	12M	Glass	Rect	G; A	No	Cavity	Elec	Mag	90	20	21 3/8
21AQP4	12D	Glass	Rect	G	No	Cavity	Mag	Mag	90	20	21 3/8
21AQP4-A	12D	Glass	Rect	G; A	No	Cavity	Mag	Mag	90	20	21 3/8
21ARP4	12N	Glass	Rect	G	Yes	Cavity	Internal Mag	Mag	70	23 3/4	21 1/2
21ARP4-A	12N	Glass	Rect	G; A	Yes	Cavity	Internal Mag	Mag	70	23 3/4	21 1/2
21ASP4	12M	Glass	Rect	G	No	Cavity	Elec	Mag	70	22 1/8	20 3/8
21ATP4	12L	Glass	Rect	G; A	Yes	Cavity	Elec	Mag	90	20	21 3/8
21ATP4-A	12L	Glass	Rect	G; A	Yes	Cavity	Elec	Mag	90	20	21 3/8

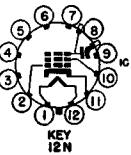
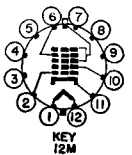
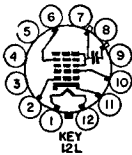
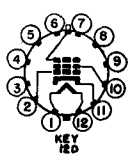

Heater Volts/ Amp	Max Anode Volts	Max Grid 2 Volts	Typical Operating Conditions							Type
			Anode Volts	Grid 2 Volts	Neg Grid 1 Cutoff Volts	RETMA Focus Coil No.	Focus Coil Dist†	Focus Current in ma	Ion Trap Magnet	
6.3/0.6	16,000 $\Delta$ +1,000, -500 $\bullet$	500	16,000 $\Delta$ 162 $\bullet$	300	28 to 72*	—	—	—	Single	20MP4
6.3/0.6	18,000	500	16,000	300	28 to 72*	109	3.0	110	Single	21AP4
6.3/0.6	20,000	500	16,000	300	28 to 72*	109	3 $\frac{3}{4}$	117	Single	21ACP4
6.3/0.6	20,000	500	16,000	300	28 to 72*	109	3 $\frac{3}{4}$	117	Single	21ACP4-A
6.3/0.6	18,000 $\Delta$ +1,000 -500 $\bullet$	500	16,000 $\Delta$ 144 $\bullet$	300	33 to 77†	—	—	—	Single	21AFP4
6.3/0.6	18,000 +1,000, -500 $\bullet$	500	16,000 $\Delta$ 144 $\bullet$	300	28 to 72*	—	—	—	Single	21ALP4
6.3/0.6	18,000 +1,000, -500 $\bullet$	500	16,000 $\Delta$ 144 $\bullet$	300	28 to 72*	—	—	—	Single	21ALP4-A
6.3/0.6	20,000 $\Delta$ +1,000 -500 $\bullet$	500	16,000 $\Delta$ 144 $\bullet$	300	28 to 72*	—	—	—	Single	21ALP4-B
6.3/0.6	18,000	500	16,000	300	28 to 72*	109	3	102	Single	21AMP4
6.3/0.6	18,000	500	16,000	300	28 to 72*	109	3	102	Single	21AMP4-A
6.3/0.6	18,000	500	16,000	300	28 to 72*	109	3	102	Single	21AMP23-A
6.3/0.6	18,000 +1,000, -500 $\bullet$	500	16,000 $\Delta$ 144 $\bullet$	300	28 to 72*	—	—	—	Single	21ANP4
6.3/0.6	18,000 +1,000, -500 $\bullet$	500	16,000 $\Delta$ 144 $\bullet$	300	28 to 72*	—	—	—	Single	21ANP4-A
6.3/0.6	18,000	500	16,000	300	28 to 72*	109	3	102	Single	21AQP4
6.3/0.6	18,000	500	16,000	300	28 to 72*	109	3	102	Single	21AQP4-A
6.3/0.6	20,000	500	13,000 to 19,000	300	28 to 72*	—	—	—	Internal	21ARP4
6.3/0.6	20,000	500	13,000 to 19,000	300	28 to 72*	—	—	—	Internal	21ARP4-A
6.3/0.6	18,000 $\Delta$ +1,000, -500 $\bullet$	500	16,000 $\Delta$ 144 $\bullet$	300	28 to 72*	—	—	—	Single	21ASP4
6.3/0.6	18,000 $\Delta$ +1,000, -500 $\bullet$	500	16,000 $\Delta$ 144 $\bullet$	300	28 to 72*	—	—	—	Single	21ATP4
6.3/0.6	20,000 $\Delta$ +1,000 -500 $\bullet$	500	16,000 $\Delta$ 144 $\bullet$	300	28 to 72*	—	—	—	Single	21ATP4-A

A—Aluminized screen to increase light output.

C—Clear (untinted) faceplate.

F—Frosted faceplate surface to reduce reflection.

G—Grey (filter) faceplate.

¶ Diagonal measurement for rectangular tubes.

‡ Distance between yoke reference line and center of focus-coil air gap; in inches.

$\Delta$  Accelerator anode and collector.

$\bullet$  Anode No. 1 (Focus); under typical operating conditions center value of voltage for focus is shown. Voltage should be adjustable about this value.

† For visual extinction of undeflected focused spot.

$\diamond$  Deflection factor.

$\circ$  Designates projection type.

\* For visual extinction of focused raster.

$\square$  Automatic electrostatic focus. No external focus connection required.

$\blacktriangle$  Intensifier No. 3 Anode.

$\ddagger$  Accelerator No. 2 Anode.

$\oplus$  Center value of voltage for convergence is shown. Modulation should be applied to improve over-all convergence.

$\text{W}$  With cylindrical contour.

Type	Base Connections	Construction	Face-plate Shape	Face-plate Finish	Ext'l Conductive Coating	Anode Contact	Focus Method	Defl Method	Defl Angle Degrees	Nom Over-all Length Inches	Nom Bulb Diam Inches
21AUP4	12L	Glass	Rect	G	Yes	Cavity	Elec	Mag	72	23 $\frac{1}{16}$	21 $\frac{3}{16}$
21AUP4-A	12L	Glass	Rect	G; A	Yes	Cavity	Elec	Mag	72	23 $\frac{1}{16}$	21 $\frac{3}{16}$
21AUP4-B	12L	Glass	Rect	G; A	Yes	Cavity	Elec	Mag	72	23 $\frac{1}{16}$	21 $\frac{3}{16}$
21AVP4	12L	Glass	Rect	G	Yes	Cavity	Elec	Mag	72	23 $\frac{1}{16}$	21 $\frac{3}{16}$
21AVP4-A	12L	Glass	Rect	G; A	Yes	Cavity	Elec	Mag	72	23 $\frac{1}{16}$	21 $\frac{3}{16}$
21AVP4-B	12L	Glass	Rect	G; A	Yes	Cavity	Elec	Mag	72	23 $\frac{1}{16}$	21 $\frac{3}{16}$
21AWP4	12N	Glass	Rect	G; A	Yes	Cavity	Mag	Mag	72	23 $\frac{1}{16}$	21 $\frac{3}{16}$
21AXP22	14W	Tricolor Tube (3-gun shadow-mask type; phosphor dots on face-plate) A			No	Flange	Elec	Mag	70	25 $\frac{1}{16}$	20 $\frac{9}{16}$
21AXP22-A	14AH	Tricolor Tube (3-gun shadow-mask type; phosphor dots on face-plate) A			Yes	Flange	Elec	Mag	70	25 $\frac{1}{16}$	20 $\frac{9}{16}$
21AYP4	12L	Glass	Rect	G	Yes	Cavity	Elec	Mag	70	22 $\frac{7}{16}$	20 $\frac{5}{16}$
21BAP4	12L	Glass	Rect	G; A	Yes	Cavity	Elec	Mag	90	20	21 $\frac{3}{16}$
21BCP4	12L	Glass	Rect	G; A	Yes	Cavity	Elec	Mag	70	23 $\frac{1}{16}$	21 $\frac{1}{16}$
21BDP4	12L	Glass	Rect	G; A	Yes	Cavity	Elec	Mag	72	23 $\frac{1}{16}$	21 $\frac{3}{16}$
21BNP4	12L	Glass	Rect	G; A	Yes	Cavity	Elec	Mag	90	20	21 $\frac{3}{16}$
21BSP4	12N	Glass	Rect	G; A	Yes	Cavity	Mag	Mag	90	20	21 $\frac{3}{16}$
21BTP4	12L	Glass	Rect	G; A	Yes	Cavity	Elec	Mag	90	20	21 $\frac{3}{16}$
21CBP4	12L	Glass	Rect	G; A	Yes	Cavity	Elec	Mag	90	18	21 $\frac{3}{16}$

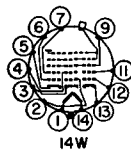
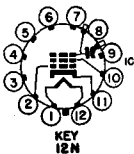
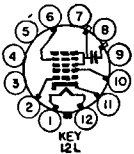



Heater Volts/ Amp	Max Anode Volts	Max Grid 2 Volts	Typical Operating Conditions							Type
			Anode Volts	Grid 2 Volts	Neg Grid 1 Cutoff Volts	RETMA Focus Coil No.	Focus Coil Dist†	Focus Current in ma	Ion Trap Magnet	
6.3/0.6	18,000 $\Delta$ +1,000 -500 $\bullet$	500	14,000 $\Delta$ 126 $\bullet$	300	28 to 72*	—	—	—	Single	21AUP4
6.3/0.6	18,000 $\Delta$ +1,000 -500 $\bullet$	500	14,000 $\Delta$ 126 $\bullet$	300	28 to 72*	—	—	—	Single	21AUP4 -A
6.3/0.6	20,000 $\Delta$ +1,000 -500 $\bullet$	500	14,000 $\Delta$ 126 $\bullet$	300	28 to 72*	—	—	—	Single	21AUP4-B
6.3/0.6	18,000 $\Delta$ +1,000 -500 $\bullet$	500	14,000 $\Delta$ 126 $\bullet$	300	28 to 72*	—	—	—	Single	21AVP4
6.3/0.6	18,000 $\Delta$ +1,000 -500 $\bullet$	500	14,000 $\Delta$ 126 $\bullet$	300	28 to 72*	—	—	—	Single	21AVP4 -A
6.3/0.6	20,000 $\Delta$ +1,000 -500 $\bullet$	500	14,000 $\Delta$ 126 $\bullet$	300	28 to 72*	—	—	—	Single	21AVP4-B
6.3/0.6	18,000	500	16,000	300	28 to 72*	109	3	95	Single	21AWP4
6.3/1.8	25,000 $\Delta$ 6,000 $\bullet$	800	20,000 $\Delta$ 3,640 $\bullet$	200	45 to 100*	Convergence method—Magnetic			Single	21AXP22
6.3/1.8	25,000 $\Delta$ 6,000 $\bullet$	800	20,000 $\Delta$ 3,640 $\bullet$	200	45 to 100*	Convergence method—Magnetic			Single	21AXP22- A
6.3/0.6	18,000 $\Delta$ +1,000 -500 $\bullet$	500	16,000 $\Delta$ 144 $\bullet$	300	28 to 72*	—	—	—	Single	21AYP4
6.3/0.6	20,000 $\Delta$ $\square$ +1,000 -500 $\bullet$	500	16,000 $\Delta$ 250 $\bullet$	300	28 to 72*	—	—	—	None	21BAP4
6.3/0.6	20,000 $\Delta$ $\square$ +1,000 -500 $\bullet$	500	16,000 $\Delta$ 300 $\bullet$	300	28 to 72*	—	—	—	None	21BCP4
6.3/0.6	20,000 $\Delta$ $\square$ +1,000 -500 $\bullet$	500	16,000 $\Delta$ 300 $\bullet$	300	28 to 72*	—	—	—	None	21BDP4
6.3/0.6	20,000 $\Delta$ +1,000 -500 $\bullet$	500	16,000 $\Delta$ 250 $\bullet$	300	28 to 72*	—	—	—	None	21BNP4
6.3/0.6	20,000	500	16,000	300	28 to 72*	109	3	116	Single	21BSP4
6.3/0.6	20,000 $\Delta$ +1,000 -500 $\bullet$	500	16,000 $\Delta$ 144 $\bullet$	300	28 to 72*	—	—	—	Single	21BTP4
6.3/0.6	18,000 $\Delta$ +1,000 -500 $\bullet$	500	14,000 $\Delta$ 123 $\bullet$	300	28 to 72*	—	—	—	None	21CBP4

A—Aluminized screen to increase light output.

C—Clear (untinted) faceplate.

F—Frosted faceplate surface to reduce reflection.

G—Grey (filter) faceplate.

¶ Diagonal measurement for rectangular tubes.

‡ Distance between yoke reference line and center of focus-coil air gap; in inches.

△ Accelerator anode and collector.

● Anode No. 1 (Focus); under typical operating conditions center value of voltage for focus is shown. Voltage should be adjustable about this value.

† For visual extinction of undeflected focused spot.

◆ Deflection factor.

● Designates projection type.

⊗ Cathode-drive Service.

\* For visual extinction of focused raster.











□ Automatic electrostatic focus. No external focus connection required.

▲ Intensifier No. 3 Anode.

‡ Accelerator No. 2 Anode.

⊕ Center value of voltage for convergence is shown. Modulation should be applied to improve over-all convergence.

‡ With cylindrical contour.

Type	Base Connections	Construction	Face-plate Shape	Face-plate Finish	Ext'l Conductive Coating	Anode Contact	Focus Method	Defl Method	Defl Angle Degrees	Nom Over-all Length Inches	Nom Bulb Diam Inches
21CBP4-A	12L	Glass	Rect	G; A	Yes	Cavity	Elec	Mag	90	18	21 3/8
21DP4	12M	Metal	Rect	G; F	Metal	Cone	Elec	Mag	70	22 5/8	20 3/4
21EP4	12D	Glass	Rect 	G	No	Cavity	Mag	Mag	70	23	21 1/2
21EP4-A	12N	Glass	Rect 	G	Yes	Cavity	Mag	Mag	70	23	21 1/2
21EP4-B	12N	Glass	Rect 	G; A	Yes	Cavity	Mag	Mag	70	23	21 1/2
21FP4	12M	Glass	Rect 	G	No	Cavity	Elec	Mag	70	23	21 1/2
21FP4-A	12L	Glass	Rect 	G	Yes	Cavity	Elec	Mag	70	23	21 1/2
21FP4-C	12L	Glass	Rect 	G; A	Yes	Cavity	Elec	Mag	70	23 1/2	21 1/2
21JP4	12N	Glass	Rect 	G	Yes	Cavity	Internal Mag	Mag	70	23 1/2	21 1/2
21JP4-A	12N	Glass	Rect 	G; A	Yes	Cavity	Internal Mag	Mag	70	23 1/2	21 1/2
21KP4	12S	Glass	Rect 	G	No	Cavity	Elec $\square$	Mag	70	22 5/8	21 5/8
21KP4-A	12P	Glass	Rect 	G	Yes	Cavity	Elec $\square$	Mag	70	23	21 1/2
21MP4	12M	Metal	Rect	G; F	Metal	Cone	Elec	Mag	70	22 1/8	20 3/4
21WP4	12N	Glass	Rect	G	Yes	Cavity	Mag	Mag	70	22 1/8	20 5/8
21WP4-A	12N	Glass	Rect	G; A	Yes	Cavity	Mag	Mag	70	22 1/8	20 5/8
21XP4	12L	Glass	Rect	G	Yes	Cavity	Elec	Mag	70	22 1/8	20 5/8
21XP4-A	12L	Glass	Rect	G; A	Yes	Cavity	Elec	Mag	70	22 1/8	20 5/8
21YP4	12L	Glass	Rect	G	Yes	Cavity	Elec	Mag	70	23 1/2	21 1/2
21YP4-A	12L	Glass	Rect	G; A	Yes	Cavity	Elec	Mag	70	23 1/2	21 1/2
21ZP4	12D	Glass	Rect	G	No	Cavity	Mag	Mag	70	23 1/2	21 1/2
21ZP4-A	12N	Glass	Rect	G	Yes	Cavity	Mag	Mag	70	23 1/2	21 1/2
21ZP4-B	12N	Glass	Rect	G; A	Yes	Cavity	Mag	Mag	70	23 1/2	21 1/2

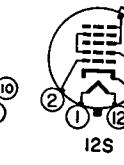
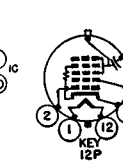
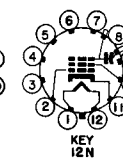
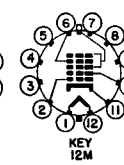
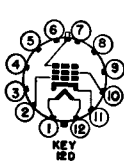

Heater Volts/ Amp	Max Anode Volts	Max Grid 2 Volts	Typical Operating Conditions							Type
			Anode Volts	Grid 2 Volts	Neg Grid 1 Cutoff Volts	RETMA Focus Coil No.	Focus Coil Dist†	Focus Current in ma	Ion Trap Magnet	
6.3/0.6	20,000 $\Delta$ +1,000 -500 $\bullet$	500	16,000 $\Delta$ 225 $\bullet$	300	28 to 72*	—	—	—	None	21CBP4-A
6.3/0.6	18,000 $\Delta$ 5,000 $\bullet$	500	16,000 $\Delta$ 3,650 $\bullet$	300	28 to 72*	—	—	—	Single	21DP4
6.3/0.6	18,000	500	12,000	300	28 to 72*	109	3.0	95	Single	21EP4
6.3/0.6	18,000	500	16,000	300	28 to 72*	109	3 $\frac{3}{4}$	116	Single	21EP4-A
6.3/0.6	18,000	500	16,000	300	28 to 72*	109	3 $\frac{3}{4}$	116	Single	21EP4-B
6.3/0.6	18,000 $\Delta$ +1,000, -500 $\bullet$	500	14,000 $\Delta$ 126 $\bullet$	300	28 to 72*	—	—	—	Single	21FP4
6.3/0.6	18,000 $\Delta$ +1,000, -500 $\bullet$	500	14,000 $\Delta$ 126 $\bullet$	300	28 to 72*	—	—	—	Single	21FP4-A
6.3/0.6	18,000 +1,000, -500 $\bullet$	500	14,000 $\Delta$ 126 $\bullet$	300	28 to 72*	—	—	—	Single	21FP4-C
6.3/0.6	20,000	500	13,000 to 19,000	300	28 to 72*	—	—	—	Internal	21JP4
6.3/0.6	20,000	500	13,000 to 19,000	300	28 to 72*	—	—	—	Internal	21JP4-A
6.3/0.6	18,000	410	12,000	300	38 to 77†	—	—	—	Single	21KP4
6.3/0.6	18,000	500	12,000	300	28 to 72*	—	—	—	Single	21KP4-A
6.3/0.6	16,000 $\Delta$ +1,000, -500 $\bullet$	500	16,000 $\Delta$ 144 $\bullet$	300	28 to 72*	—	—	—	Single	21MP4
6.3/0.6	18,000	500	16,000	300	28 to 72*	109	3 $\frac{3}{4}$	100	Single	21WP4
6.3/0.6	18,000	500	16,000	300	28 to 72*	109	3 $\frac{3}{4}$	100	Single	21WP4-A
6.3/0.6	18,000 +1,000, -500 $\bullet$	500	16,000 $\Delta$ 144 $\bullet$	300	28 to 72*	—	—	—	Single	21XP4
6.3/0.6	18,000 +1,000, -500 $\bullet$	500	16,000 $\Delta$ 144 $\bullet$	300	28 to 72*	—	—	—	Single	21XP4-A
6.3/0.6	18,000 +1,000, -500 $\bullet$	500	16,000 $\Delta$ 144 $\bullet$	300	28 to 72*	—	—	—	Single	21YP4
6.3/0.6	18,000 +1,000, -500 $\bullet$	500	16,000 $\Delta$ 144 $\bullet$	300	28 to 72*	—	—	—	Single	21YP4-A
6.3/0.6	18,000	500	16,000	300	28 to 72*	109	3 $\frac{3}{4}$	118	Single	21ZP4
6.3/0.6	18,000	500	16,000	300	28 to 72*	109	3 $\frac{3}{4}$	118	Single	21ZP4-A
6.3/0.6	18,000	500	16,000	300	28 to 72*	109	3 $\frac{3}{4}$	118	Single	21ZP4-B

A—Aluminized screen to increase light output.

C—Clear (untinted) faceplate.

F—Frosted faceplate surface to reduce reflection.

G—Grey (filter) faceplate.

¶ Diagonal measurement for rectangular tubes.

‡ Distance between yoke reference line and center of focus-coil air gap; in inches.

$\Delta$  Accelerator anode and collector.

$\bullet$  Anode No. 1 (Focus); under typical operating conditions center value of voltage for focus is shown. Voltage should be adjustable about this value.

† For visual extinction of undeflected focused spot.

$\diamond$  Deflection factor.

$\bullet$  Designates projection type.

\* For visual extinction of focused raster.

$\square$  Automatic electrostatic focus. No external focus connection required.

$\blacktriangle$  Intensifier No. 3 Anode.

$\blacktriangleright$  Accelerator No. 2 Anode.

$\oplus$  Center value of voltage for convergence is shown. Modulation should be applied to improve over-all convergence.

$\blacksquare$  With cylindrical contour.

Type	Base Connections	Construction	Face-plate Shape	Face-plate Finish	Ext'l Con-ductive Coating	Anode Contact	Focus Method	Defl Method	Defl Angle Degrees	Nom Over-all Length Inches	Nom Bulb Diam Inches†
22AP4	12D	Metal	Round	C	Metal	Cone	Mag	Mag	70	22 1/8	21 1/2
22AP4-A	12D	Metal	Round	G	Metal	Cone	Mag	Mag	70	22 1/8	21 1/2
22EP22	22-EP22	Tricolor Tube (3-gun shadow-mask type; phosphor-dots on face-plate)			Yes	Cavity	Elec	Mag	72	25 3/8	22 1/4
24AP4	12D	Metal	Round	G	Metal	Cone	Mag	Mag	70	23 1/2	24
24AP4-A	12D	Metal	Round	G; A	Metal	Cone	Mag	Mag	70	23 1/2	24
24AP4-B	12D	Metal	Round	G; F	Metal	Cone	Mag	Mag	70	23 1/2	24
24ADP4	12N	Glass	Rect	G; A	Yes	Cavity	Mag	Mag	90	21 1/8	24
24BP4	12M	Metal	Round	G	Metal	Cone	Elec	Mag	70	24 1/4	24
24CP4	12N	Glass	Rect	G	Yes	Cavity	Mag	Mag	90	21 1/8	24
24CP4-A	12N	Glass	Rect	G; A	Yes	Cavity	Mag	Mag	90	21 1/8	24
24DP4	12L	Glass	Rect	G	Yes	Cavity	Elec	Mag	90	21 1/8	24
24DP4-A	12L	Glass	Rect	G; A	Yes	Cavity	Elec	Mag	90	21 1/8	24
24QP4	12N	Glass	Rect	G	Yes	Cavity	Mag	Mag	90	21 1/8	24
24TP4	12N	Glass	Rect	G; A	Yes	Cavity	Mag	Mag	90	21 1/8	24
24VP4	12N	Glass	Rect	G	Yes	Cavity	Mag	Mag	90	21 1/8	24
24VP4-A	12N	Glass	Rect	G; A	Yes	Cavity	Mag	Mag	90	21 1/8	24
24XP4	12D	Glass	Rect	G	No	Cavity	Mag	Mag	90	21 1/8	24
24YP4	12L	Glass	Rect	G; A	Yes	Cavity	Elec	Mag	90	21 1/8	24
24ZP4	12L	Glass	Rect	G; A	Yes	Cavity	Elec	Mag	90	21 1/8	24
27AP4	12M	Metal	Rect	G; F	Metal	Cone	Elec	Mag	90	21 5/8	26 1/8
27EP4	12D	Glass	Rect	G; A	No	Cavity	Mag	Mag	90	23 1/4	26 1/2
27GP4	12D	Glass	Rect	G	No	Cavity	Mag	Mag	90	23 1/4	26 1/2
27LP4	12N	Glass	Rect	G; A	Yes	Cavity	Mag	Mag	90	23 1/4	26 1/2
27MP4	12D	Metal	Rect	G; F; A	No	Cavity	Mag	Mag	90	23 1/4	26 1/2
27NP4	12N	Glass	Rect	G	Yes	Cavity	Mag	Mag	90	23 1/4	26 1/2

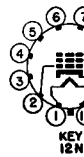
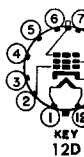

Heater Volts/ Amp	Max Anode Volts	Max Grid 2 Volts	Typical Operating Conditions							Type
			Anode Volts	Grid 2 Volts	Neg Grid 1 Cutoff Volts	RETMA Focus Coil No.	Focus Coil Dist†	Focus Current in ma	Ion Trap Magnet	
6.3/0.6	19,000	410	14,000	300	28 to 72*	109	3.0	117	Single	22AP4
6.3/0.6	19,000	410	14,000	300	28 to 72*	109	3.0	117	Single	22AP4-A
6.3/1.8	25,000 Δ 6,000 ●	800	25,000 Δ 4,550 ●	200	55 to 105*	Convergence method—Magnetic			Single	22EP22
6.3/0.6	16,000	410	15,000	300	28 to 72*	109	3½	114	Single	24AP4
6.3/0.6	16,000	410	15,000	300	33 to 77†	109	3½	117	Single	24AP4-A
6.3/0.6	16,000	410	15,000	300	28 to 72*	109	3	114	Single	24AP4-B
6.3/0.6	22,000	600	18,000	300	28 to 72*	109	3	125	Single	24ADP4
6.3/0.6	16,000 Δ +1,000 -500 ●	500	14,000 Δ 126 ●	300	28 to 72*	—	—	—	Single	24BP4
6.3/0.6	20,000	500	18,000	300	28 to 72*	109	3	115	Single	24CP4
6.3/0.6	20,000	500	18,000	300	28 to 72*	109	3	115	Single	24CP4-A
6.3/0.6	20,000 +1,000 -500 ●	500	18,000 Δ 162 ●	300	28 to 72*	—	—	—	Single	24DP4
6.3/0.6	20,000 +1,000 -500 ●	500	18,000 Δ 162 ●	300	28 to 72*	—	—	—	Single	24DP4-A
6.3/0.6	18,000	500	16,000	300	28 to 72*	109	3½	100	Single	24QP4
6.3/0.6	20,000	500	18,000	300	28 to 72*	109	—	125	Single	24TP4
6.3/0.6	22,000	600	20,000	300	28 to 72*	109	3	125	Single	24VP4
6.3/0.6	22,000	600	20,000	300	28 to 72*	109	3	125	Single	24VP4-A
6.3/0.6	20,000	500	18,000	300	28 to 72*	109	3	125	Single	24XP4
6.3/0.6	20,000 Δ +1,000 -500 ●	500	18,000 Δ 162 ●	300	28 to 72*	—	—	—	Single	24YP4
6.3/0.6	20,000 Δ □ +1,000 -500 ●	500	16,000 Δ 250 ●	300	28 to 72*	—	—	—	None	24ZP4
6.3/0.6	18,000 Δ +1,000 -500 ●	500	15,000 Δ 135 ●	300	28 to 72*	—	—	—	Single	27AP4
6.3/0.6	20,000	500	16,000	300	28 to 72*	109	3¾	117	Single	27EP4
6.3/0.6	22,500	500	16,000	300	28 to 72*	109	—	95	Single	27GP4
6.3/0.6	22,000	600	20,000	300	28 to 72*	109	—	148	Single	27LP4
6.3/0.6	18,000	500	16,000	300	28 to 72*	109	3	110	Single	27MP4
6.3/0.6	18,000	500	16,000	300	28 to 72*	109	3¾	95	Single	27NP4

A—Aluminized screen to increase light output.

C—Clear (untinted) faceplate.

F—Frosted faceplate surface to reduce reflection.

G—Grey (filter) faceplate.

‡ Diagonal measurement for rectangular tubes.

† Distance between yoke reference line and center of focus-coil air gap; in inches.

Δ Accelerator anode and collector.

● Anode No. 1 (Focus); under typical operating conditions center value of voltage for focus is shown. Voltage should be adjustable about this value.

† For visual extinction of undeflected focused spot.

◆ Deflection factor.

● Designates projection type.

□ Cathode-drive Service.

\* For visual extinction of focused raster.

□ Automatic electrostatic focus. No external focus connection required.

▲ Intensifier No. 3 Anode.

‡ Accelerator No. 2 Anode.

⊕ Center value of voltage for convergence is shown. Modulation should be applied to improve over-all convergence.

‡ With cylindrical contour.

Type	Base Connections	Construction	Face-plate Shape	Face-plate Finish	Ext'l Conductive Coating	Anode Contact	Focus Method	Defl Method	Defl Angle Degrees	Nom Overall Length Inches	Nom Bulb Diam Inches
27RP4	12N	Glass	Rect	G; A	Yes	Cavity	Mag	Mag	90	23 $\frac{1}{8}$	26 $\frac{1}{8}$
27SP4	12L	Glass	Rect	G; A	Yes	Cavity	Elec	Mag	90	23 $\frac{1}{8}$	26 $\frac{1}{8}$
27UP4	12L	Glass	Rect	G	Yes	Cavity	Elec	Mag	90	23 $\frac{1}{8}$	26 $\frac{1}{8}$
30BP4	12D	Metal	Round	G	Metal	Cone	Mag	Mag	90	23 $\frac{3}{8}$	30 $\frac{1}{8}$
MW22-2	5A	Glass	Round	C	No	Base	Mag	Mag	50	15 $\frac{3}{8}$	9 $\frac{1}{8}$
MW31-3	5A	Glass	Round	C	No	Base	Mag	Mag	50	18 $\frac{7}{8}$	12 $\frac{1}{8}$
TP400-A ●	TP400-A	Glass	Round	C	Yes	—	Mag	Mag	50	12 $\frac{3}{8}$	4

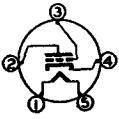

5A

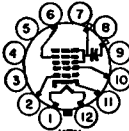
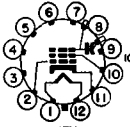
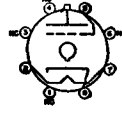
KEY  
12DKEY  
12LKEY  
12M

TP-400A

Heater Volts/ Amp	Max Anode Volts	Max Grid 2 Volts	Typical Operating Conditions							Type
			Anode Volts	Grid 2 Volts	Neg Grid 1 Cutoff Volts	RETMA Focus Coil No.	Focus Coil Dist†	Focus Current in ma	Ion Trap Magnet	
6.3/0.6	20,000	500	16,000	300	28 to 72*	109	3	105	Single	27RP4
6.3/0.6	20,000 Δ +1,000, -500 ●	500	18,000 Δ 162 ●	300	28 to 72*	—	—	—	Single	27SP4
6.3/0.6	20,000 Δ	500	16,000 Δ 198 ●	300	28 to 72*	—	—	—	Single	27UP4
6.3/0.6	30,000	.410	22,000	300	28 to 72*	109	3.0	128	Single	30BP4
6.3/0.6	6,000	330	5,000	250	100†	—	—	—	None	MW22-2
6.3/0.6	6,000	330	5,000	250	100†	—	—	—	None	MW31-3
6.3/0.6	22,000	—	20,000	—	70 to 140 †	—	—	144	None	TP400-A

A—Aluminized screen to increase light output.

C—Clear (untinted) faceplate.

F—Frosted faceplate surface to reduce reflection.

G—Grey (filter) faceplate.

‡ Diagonal measurement for rectangular tubes.

† Distance between yoke reference line and center of focus-coil air gap; in inches.

Δ Accelerator anode and collector.

● Anode No. 1 (Focus); under typical operating conditions center value of voltage for focus is shown. Voltage should be adjustable about this value.

† For visual extinction of undeflected focused spot.

◆ Deflection factor.

● Designates projection type.

\* For visual extinction of focused raster.

□ Automatic electrostatic focus. No external focus connection required.

▲ Intensifier No. 3 Anode.

‡ Accelerator No. 2 Anode.

⊕ Center value of voltage for convergence is shown. Modulation should be applied to improve over-all convergence.

⚡ With cylindrical contour.

## X-RAY RADIATION FROM TV PICTURE TUBES

Cathode-ray tubes rated at anode voltages in excess of 16,000 volts may require x-ray radiation shielding to avert possible danger of personal injury from prolonged exposure at close range. The protective face-viewing window of apparatus using tubes of this type may provide such a safeguard. If the radiation measured in contact with this window is not in excess of 6.25 milliroentgens per hour, the window will normally provide adequate protection.

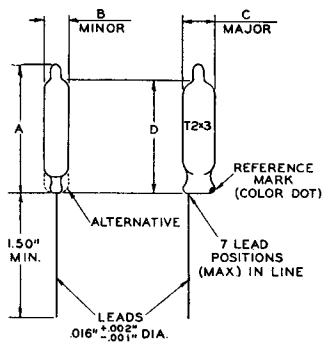

OUTLINE DRAWING NUMBER	DIMENSIONS			
	A MAX.	B MAX.	C MAX.	D MIN. MAX.
2-1	1.50"	.285"	.385"	1.20" 1.40"
2-2	1.25"	.285"	.385"	0.97" 1.17"
2-3	1.50"	.285"	.410"	1.20" 1.40"
2-4	1.25"	.285"	.410"	0.97" 1.17"
2-5	1.50"	.285"	.400"	1.20" 1.40"
2-6	1.25"	.285"	.400"	0.97" 1.17"

2-1 TO 2-6

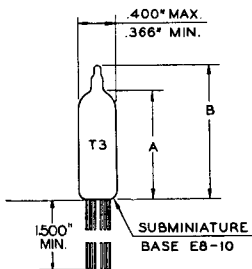

OUTLINE DRAWING NUMBER	DIMENSIONS	
	A ±0.060"	B MAX.
3-1	1.075"	1.375"
3-2	1.200"	1.500"
3-3	1.450"	1.750"
3-4	1.700"	2.000"
3-8	1.325"	1.625"

3-1 TO 3-4, 3-8

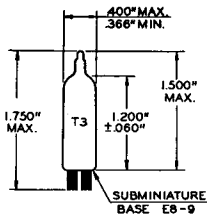

3-5

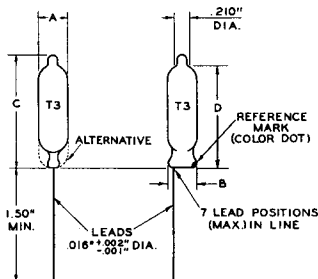

OUTLINE DRAWING NUMBER	DIMENSIONS			
	A MAX.	B MAX.	C MAX.	D MIN. MAX.
3-6	.400"	.400"	1.50"	1.15" 1.35"
3-7	.400"	.410"	1.50"	1.15" 1.35"

3-6, 3-7



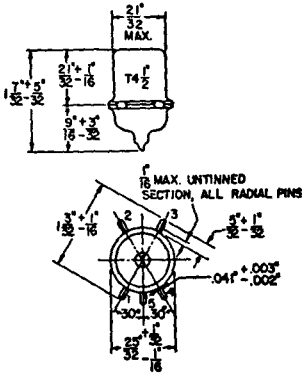

4-1

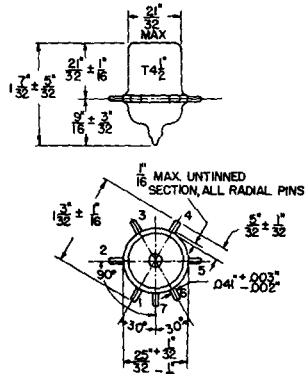

4-2

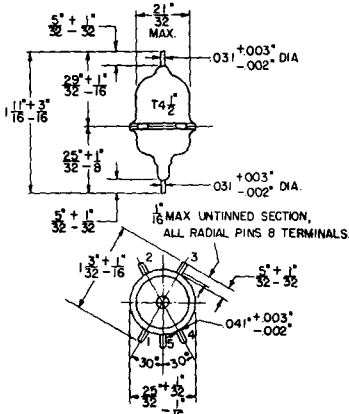

4-3

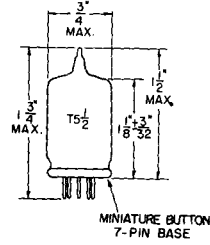

5-1

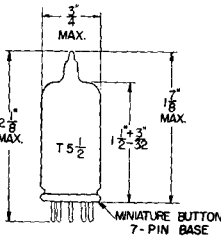

5-2

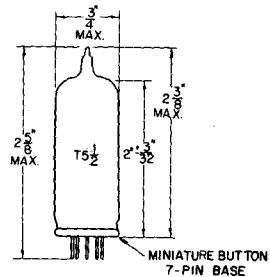

5-3

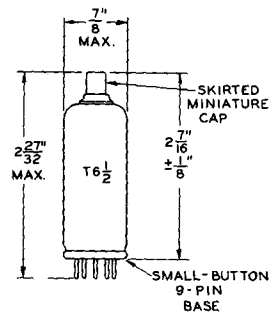
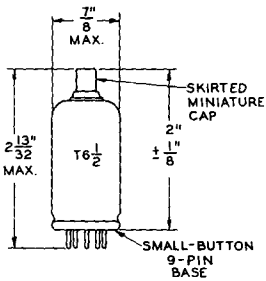
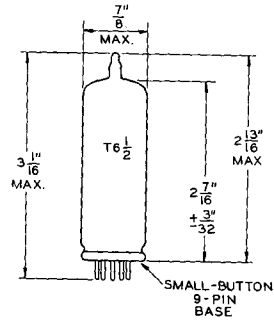
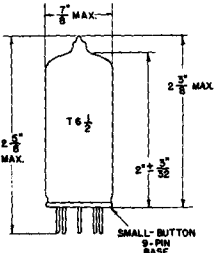
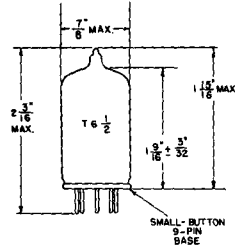
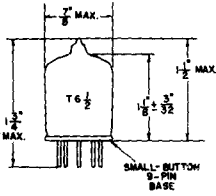

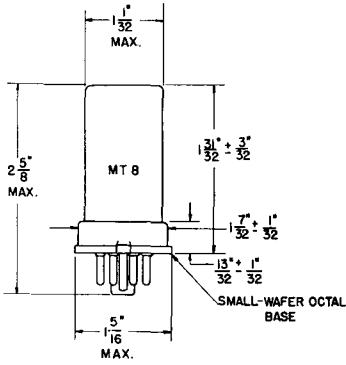

8-1

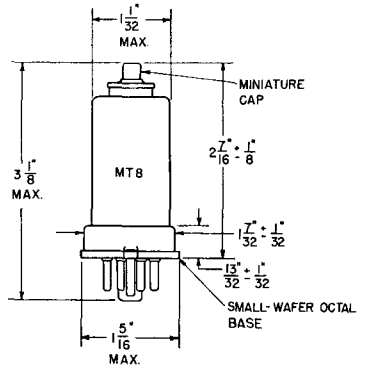

8-2

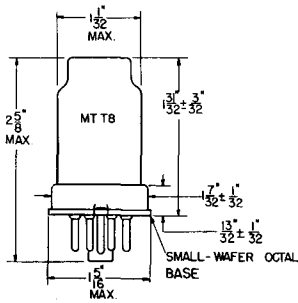

8-3

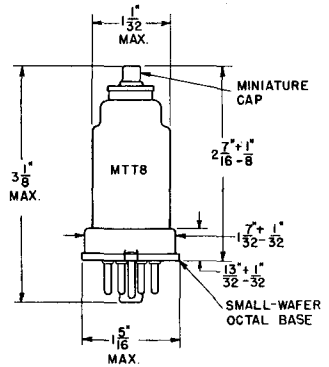

8-4

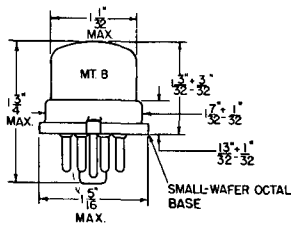

8-5

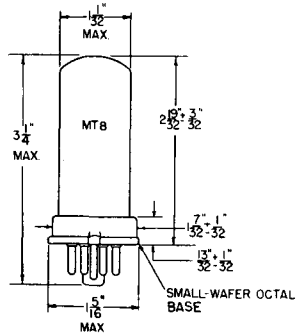

8-6

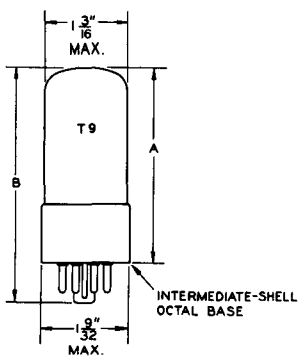

OUTLINE DRAWING NUMBER	DIMENSIONS	
	A MAX.	B MAX.
9-1	1 $\frac{3}{4}$	2 $\frac{5}{16}$
9-3	2 $\frac{5}{16}$	2 $\frac{7}{8}$
9-5	2 $\frac{7}{16}$	3"
9-7	2 $\frac{1}{2}$	3 $\frac{1}{16}$
9-9	2 $\frac{11}{16}$	3 $\frac{1}{4}$
9-11	2 $\frac{3}{4}$	3 $\frac{5}{16}$
9-13	2 $\frac{13}{16}$	3 $\frac{3}{8}$
9-15	2 $\frac{7}{8}$	3 $\frac{7}{16}$
9-33	3 $\frac{1}{4}$	3 $\frac{13}{16}$

9-1 TO 9-15 (ODD), 9-33

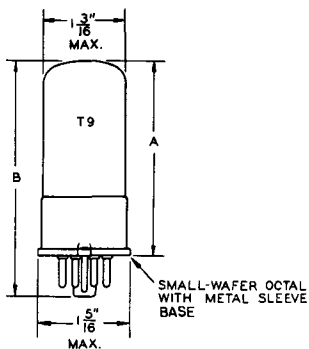

OUTLINE DRAWING NUMBER	DIMENSIONS	
	A MAX.	B MAX.
9-2	1 $\frac{3}{4}$	2 $\frac{5}{16}$
9-4	2 $\frac{5}{16}$	2 $\frac{7}{8}$
9-6	2 $\frac{7}{16}$	3"
9-8	2 $\frac{1}{2}$	3 $\frac{1}{16}$
9-10	2 $\frac{11}{16}$	3 $\frac{1}{4}$
9-12	2 $\frac{3}{4}$	3 $\frac{5}{16}$
9-14	2 $\frac{13}{16}$	3 $\frac{3}{8}$
9-16	2 $\frac{7}{8}$	3 $\frac{7}{16}$

9-2 TO 9-16 (EVEN)

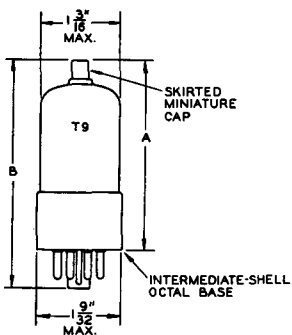

OUTLINE DRAWING NUMBER	DIMENSIONS		
	MIN.	A MAX.	B MAX.
9-17	2 $\frac{5}{16}$	2 $\frac{3}{4}$	3 $\frac{5}{16}$
9-19	2 $\frac{5}{16}$	2 $\frac{7}{8}$	3 $\frac{7}{16}$
9-21	2 $\frac{5}{16}$	2 $\frac{15}{16}$	3 $\frac{1}{2}$
9-23	2 $\frac{5}{16}$	3"	3 $\frac{9}{16}$
9-50	2 $\frac{7}{8}$	3 $\frac{5}{16}$	3 $\frac{7}{8}$

9-17 TO 9-23 (ODD), 9-50

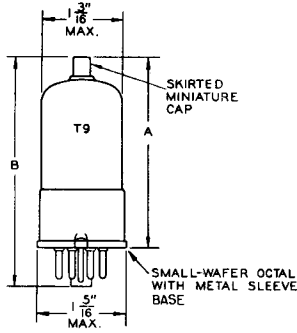

OUTLINE DRAWING NUMBER	DIMENSIONS			
	A		B	
	MIN.	MAX.	MIN.	MAX.
9-18	2 5/16	2 3/4	3 5/16	3 7/16
9-20	2 5/16	2 7/8	3 7/16	3 7/16
9-22	2 5/16	2 15/16	3 2"	3 2"
9-24	2 5/16	3"	3 9/16	3 9/16

9-18 TO 9-24 (EVEN)

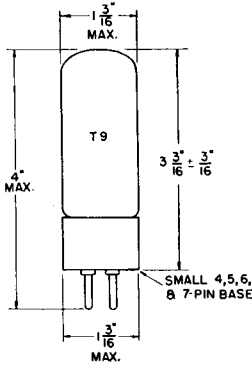

9-25

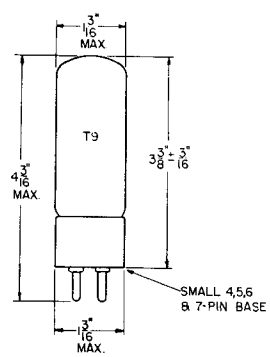

9-26

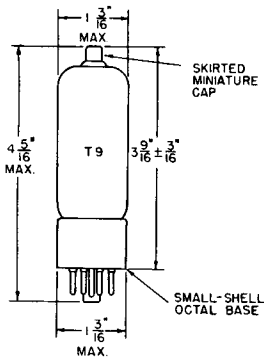

9-28

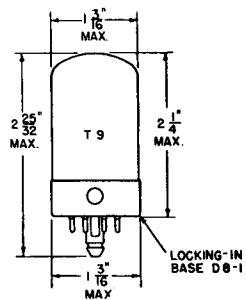

9-30

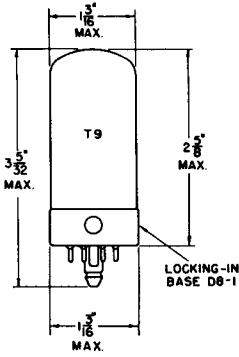

9-31

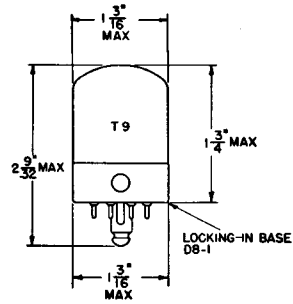

9-32

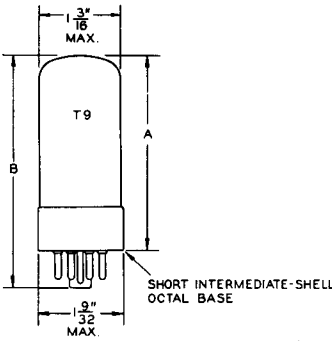

9-36 TO 9-44

OUTLINE DRAWING NUMBER	DIMENSIONS	
	A MAX.	B MAX.
9-36	1 <sup>3</sup> / <sub>4</sub>	2 <sup>5</sup> / <sub>16</sub>
9-37	2 <sup>5</sup> / <sub>16</sub>	2 <sup>7</sup> / <sub>8</sub>
9-38	2 <sup>7</sup> / <sub>16</sub>	3"
9-39	2 <sup>1</sup> / <sub>2</sub>	3 <sup>1</sup> / <sub>16</sub>
9-40	2 <sup>11</sup> / <sub>16</sub>	3 <sup>1</sup> / <sub>4</sub>
9-41	2 <sup>3</sup> / <sub>4</sub>	3 <sup>5</sup> / <sub>16</sub>
9-42	2 <sup>13</sup> / <sub>16</sub>	3 <sup>3</sup> / <sub>8</sub>
9-43	2 <sup>7</sup> / <sub>8</sub>	3 <sup>7</sup> / <sub>16</sub>
9-44	3 <sup>1</sup> / <sub>4</sub>	3 <sup>13</sup> / <sub>16</sub>

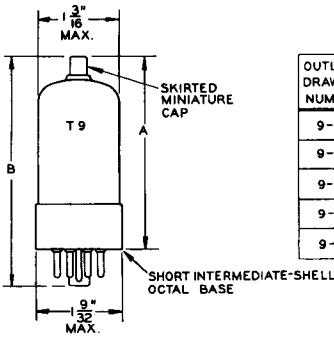

9-45 TO 9-49

OUTLINE DRAWING NUMBER	DIMENSIONS		
	A		B
	MIN.	MAX.	MAX.
9-45	2 <sup>5</sup> / <sub>16</sub>	2 <sup>3</sup> / <sub>4</sub>	3 <sup>5</sup> / <sub>16</sub>
9-46	2 <sup>5</sup> / <sub>16</sub>	2 <sup>7</sup> / <sub>8</sub>	3 <sup>7</sup> / <sub>16</sub>
9-47	2 <sup>5</sup> / <sub>16</sub>	2 <sup>15</sup> / <sub>16</sub>	3 <sup>1</sup> / <sub>2</sub>
9-48	2 <sup>5</sup> / <sub>16</sub>	3"	3 <sup>9</sup> / <sub>16</sub>
9-49	2 <sup>7</sup> / <sub>8</sub>	3 <sup>5</sup> / <sub>16</sub>	3 <sup>7</sup> / <sub>8</sub>

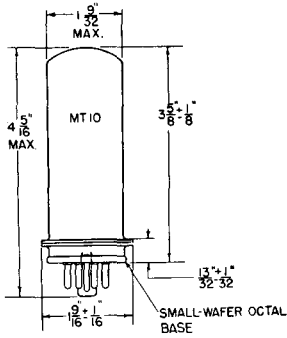

10-1

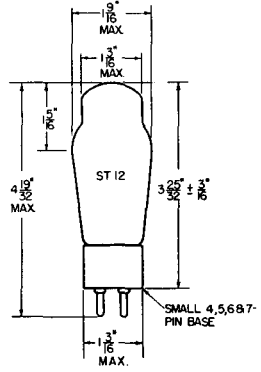

12-1

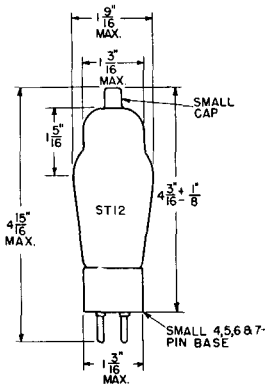

12-2

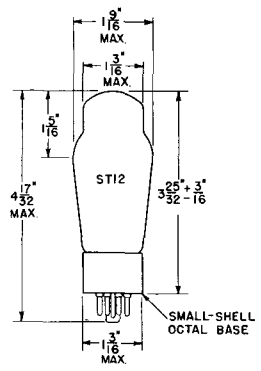

12-3

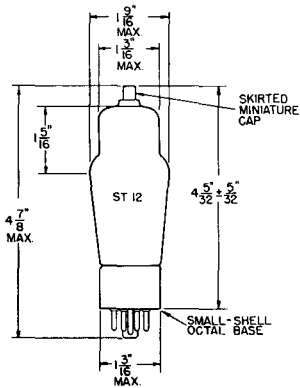

12-4

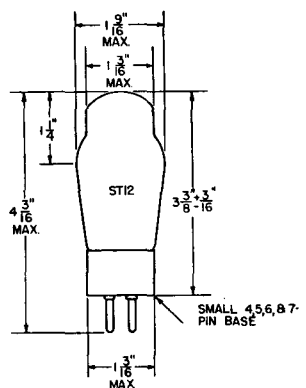

12-5

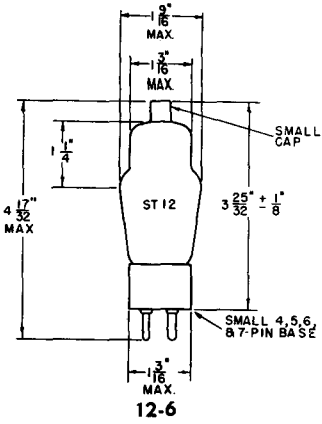

12-6

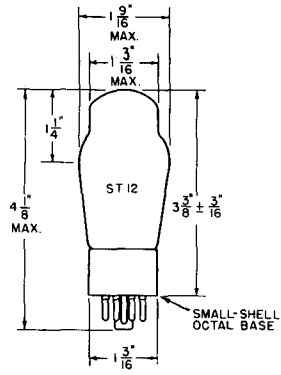

12-7

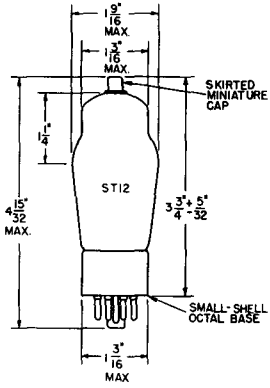

12-8

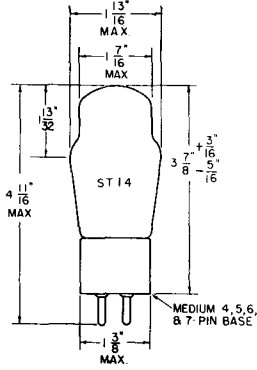

14-1

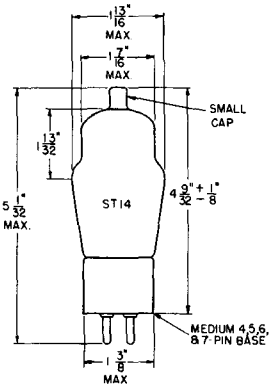

14-2

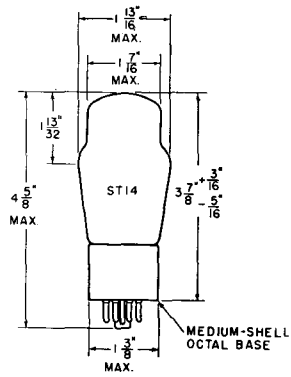

14-3



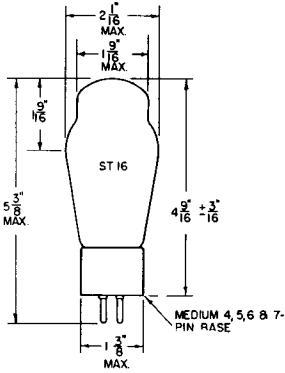

16-1

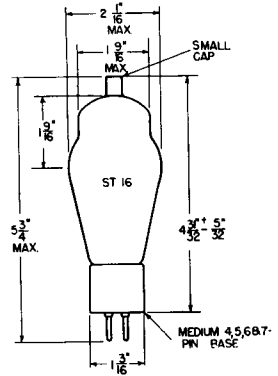

16-2

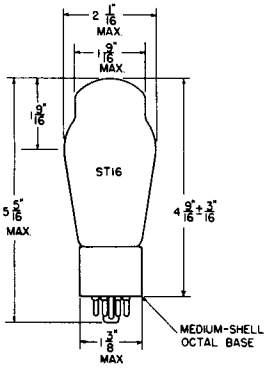

16-3

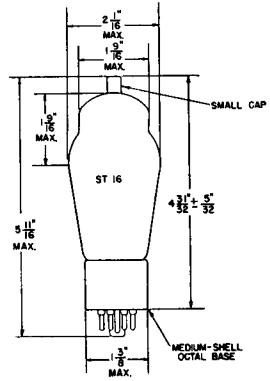

16-5

## T-X TABLE – Physical Characteristics of Types

Tube Type	Envelope	Style	Max Dimensions in Inches		
			Diameter	Over-all Length	Seated Height
0Y4-G	T-7	Octal	$1\frac{5}{64}$	$2\frac{5}{8}$	$2\frac{1}{16}$
0Z4-G	T-7	Octal	$1\frac{1}{16}$	$2\frac{5}{8}$	$2\frac{1}{16}$
1AB6	T-5½	7-Pin Miniature	$\frac{3}{4}$	2.205	1.955
1AE5	T-2 x 3	Inline Subm-FL*	0.400 x 0.300	—	1.5
1AH5	T-5½	7-Pin Miniature	$\frac{3}{4}$	2.205	1.955
1AJ4	T-5½	7-Pin Miniature	$\frac{3}{4}$	2.205	1.955
1B3-GT	T-9	Octal	$1\frac{9}{32}$	$4\frac{1}{16}$	$3\frac{1}{2}$
1N6-G	T-9	Octal	$1\frac{3}{16}$	4	$3\frac{7}{16}$
1S2	T-6½	9-Pin Miniature	$\frac{7}{8}$	2.913	2.658
1S2-A	T-6½	9-Pin Miniature	$\frac{7}{8}$	2.913	2.658
1T2	—	Special-FL*	$1\frac{7}{32}$	$1\frac{29}{32}$	—
1Y2	ST-12	4-Pin	$1\frac{9}{16}$	$4\frac{19}{32}$	$3\frac{31}{32}$
1Z2	T-5½	7-Pin Miniature	$\frac{3}{4}$	2.70	2.45
2B3	T-9	6-Pin Octal	$1\frac{9}{32}$	$4\frac{1}{16}$	$3\frac{1}{2}$
2C22	T-9	Octal	$1\frac{5}{16}$	$3\frac{1}{4}$	$2\frac{11}{16}$
2C50	T-9	Octal	1.315	$2\frac{3}{4}$	$3\frac{5}{16}$
2E31	T-2 x 3	Inline Subm-FL*	0.400 x 0.300	—	$1\frac{9}{16}$
2E32	T-2 x 3	Inline Subm-SL*	0.400 x 0.300	—	$1\frac{9}{16}$
2E35	T-2 x 3	Inline Subm-FL*	0.390 x 0.290	—	$1\frac{9}{16}$
2E36	T-2 x 3	Inline Subm-SL*	0.390 x 0.290	—	$1\frac{9}{16}$
2E41	T-2 x 3	Inline Subm-FL*	0.390 x 0.290	—	$1\frac{9}{16}$
2E42	T-2 x 3	Inline Subm-SL*	0.390 x 0.290	—	$1\frac{9}{16}$
2G21	T-2 x 3	Inline Subm-FL*	0.400 x 0.300	—	$1\frac{9}{16}$
2G22	T-2 x 3	Inline Subm-SL*	0.400 x 0.300	—	$1\frac{9}{16}$
2V2	T-11	Octal	$1\frac{7}{16}$	$4\frac{1}{2}$	$3\frac{15}{16}$
3A3	T-9	Octal	$1\frac{9}{32}$	$4\frac{1}{16}$	$3\frac{1}{2}$
3B2	T-12	Octal	$1\frac{23}{32}$	$5\frac{7}{32}$	$4\frac{11}{16}$
3C2	T-12	Octal	$1\frac{9}{16}$	$4\frac{1}{2}$	$3\frac{15}{16}$
3C4	T-5½	7-Pin Miniature	$\frac{3}{4}$	2.205	1.955
5AR4	—	Octal	$1\frac{1}{2}$	$3\frac{7}{16}$	$2\frac{3}{8}$
5AU4	T-12	Octal	$1\frac{11}{16}$	$4\frac{3}{4}$	$4\frac{3}{16}$
5AW4	T-12	Octal	$1\frac{1}{2}$	$5\frac{3}{16}$	$4\frac{3}{8}$
5R4-GYA	T-12	Octal	$1\frac{9}{16}$	$4\frac{5}{16}$	$4\frac{3}{8}$

\*FL—Flying Leads  
SL—Short Leads

## Not Conforming to Standard Outline Drawings

Tube Type	Envelope	Style	Max Dimensions in Inches		
			Diameter	Over-all Length	Seated Height
5U4-GA	T-11	Octal	1 <sup>7</sup> / <sub>16</sub>	4 <sup>3</sup> / <sub>4</sub>	4 <sup>3</sup> / <sub>16</sub>
5U4-GB	T-12	Octal	1 <sup>9</sup> / <sub>16</sub>	4 <sup>3</sup> / <sub>4</sub>	4 <sup>3</sup> / <sub>16</sub>
5V3	T-12	Octal	1 <sup>9</sup> / <sub>16</sub>	4 <sup>3</sup> / <sub>4</sub>	4 <sup>3</sup> / <sub>16</sub>
5V4-GA	T-12	Octal	1 <sup>9</sup> / <sub>16</sub>	3 <sup>7</sup> / <sub>8</sub>	3 <sup>5</sup> / <sub>16</sub>
5X4-GA	T-12	Octal	1 <sup>9</sup> / <sub>16</sub>	4 <sup>3</sup> / <sub>4</sub>	4 <sup>3</sup> / <sub>16</sub>
5Y3-GA	T-12	Octal	1 <sup>9</sup> / <sub>16</sub>	4 <sup>5</sup> / <sub>8</sub>	4 <sup>1</sup> / <sub>16</sub>
5Y4-GA	T-12	Octal	1 <sup>9</sup> / <sub>16</sub>	4 <sup>5</sup> / <sub>8</sub>	4 <sup>1</sup> / <sub>16</sub>
6AE8	T-6 <sup>1</sup> / <sub>2</sub>	9-Pin Miniature	<sup>7</sup> / <sub>8</sub>	2 <sup>1</sup> / <sub>4</sub>	—
6AL6-G	ST-16	Octal	2 <sup>1</sup> / <sub>16</sub>	5 <sup>11</sup> / <sub>16</sub>	5 <sup>3</sup> / <sub>8</sub>
6AR6	T-11	Octal	1 <sup>7</sup> / <sub>16</sub>	3 <sup>15</sup> / <sub>32</sub>	2 <sup>29</sup> / <sub>32</sub>
6AR7-GT	T-9	Octal	1 <sup>5</sup> / <sub>16</sub>	3 <sup>5</sup> / <sub>8</sub>	3 <sup>1</sup> / <sub>16</sub>
6AS7-GA	T-12	Octal	1 <sup>9</sup> / <sub>16</sub>	4 <sup>5</sup> / <sub>8</sub>	4 <sup>1</sup> / <sub>16</sub>
6AV5-GA	T-11 or T-12	Octal	1 <sup>7</sup> / <sub>16</sub> 1 <sup>9</sup> / <sub>16</sub>	4 4	3 <sup>7</sup> / <sub>16</sub> 3 <sup>1</sup> / <sub>16</sub>
6AZ6	T-3	Button Subm-FL*	0.400	—	1.25
6BA4	—	Rocket Type	1.005	2 <sup>7</sup> / <sub>16</sub>	—
6BD4	T-12	Octal	1 <sup>23</sup> / <sub>32</sub>	5 <sup>3</sup> / <sub>8</sub>	4 <sup>5</sup> / <sub>8</sub>
6BD4-A	T-12	Octal	1 <sup>23</sup> / <sub>32</sub>	5 <sup>3</sup> / <sub>8</sub>	4 <sup>5</sup> / <sub>8</sub>
6BD5-GT	T-9	Octal	1 <sup>9</sup> / <sub>32</sub>	3 <sup>7</sup> / <sub>8</sub>	3 <sup>5</sup> / <sub>16</sub>
6BG6-GA	T-12	Octal	1 <sup>9</sup> / <sub>16</sub>	5	4 <sup>7</sup> / <sub>16</sub>
6BJ5	T-5 <sup>1</sup> / <sub>2</sub>	7-Pin Miniature	<sup>3</sup> / <sub>4</sub>	2 <sup>3</sup> / <sub>4</sub>	—
6BK4	T-12	Octal	1 <sup>23</sup> / <sub>32</sub>	5 <sup>7</sup> / <sub>32</sub>	4 <sup>1</sup> / <sub>16</sub>
6BL4	T-12	Octal	1 <sup>23</sup> / <sub>32</sub>	4 <sup>5</sup> / <sub>8</sub>	4 <sup>1</sup> / <sub>16</sub>
6BQ6-GA	T-11 or T-12	Octal	1 <sup>7</sup> / <sub>16</sub> 1 <sup>9</sup> / <sub>16</sub>	4 <sup>1</sup> / <sub>4</sub> 4 <sup>1</sup> / <sub>4</sub>	3 <sup>11</sup> / <sub>16</sub> 3 <sup>1</sup> / <sub>16</sub>
6BT4	T-6 <sup>1</sup> / <sub>2</sub>	8-Pin Miniature	<sup>7</sup> / <sub>8</sub>	3 <sup>3</sup> / <sub>16</sub>	2 <sup>29</sup> / <sub>32</sub>
6BU4	T-12	Octal	1 <sup>23</sup> / <sub>32</sub>	5 <sup>1</sup> / <sub>16</sub>	4 <sup>17</sup> / <sub>32</sub>
6BU5	T-12	Octal	1 <sup>1</sup> / <sub>16</sub>	4 <sup>7</sup> / <sub>8</sub>	4 <sup>5</sup> / <sub>16</sub>
6BY4	Special	Ceramic	0.33	0.438	—
6BY5-GA	T-12	Octal	1 <sup>9</sup> / <sub>16</sub>	3 <sup>7</sup> / <sub>8</sub>	3 <sup>5</sup> / <sub>16</sub>
6CA7	T-10	Octal	1 <sup>1</sup> / <sub>2</sub>	4 <sup>7</sup> / <sub>16</sub>	3 <sup>7</sup> / <sub>8</sub>
6CB5	ST-16	Octal	2 <sup>1</sup> / <sub>16</sub>	5 <sup>3</sup> / <sub>8</sub>	4 <sup>13</sup> / <sub>32</sub>
6CB5-A	T-12	Octal	1 <sup>23</sup> / <sub>32</sub>	5	4 <sup>7</sup> / <sub>16</sub>
6CD6-GA	T-12	Octal	1 <sup>9</sup> / <sub>16</sub>	5	4 <sup>7</sup> / <sub>16</sub>

\*FL—Flying Leads

SL—Short Leads

# OUTLINE

## T-X TABLE – Physical Characteristics of Types

Tube Type	Envelope	Style	Max Dimensions in Inches		
			Diameter	Over-all Length	Seated Height
6CD7	—	Octal	$1\frac{3}{32}$	$3\frac{19}{32}$	$3\frac{1}{32}$
6CJ5	T-6½	8-Pin Miniature	$\frac{7}{8}$	2½	$2\frac{1}{16}$
6CJ6	T-6½	9-Pin Miniature	$\frac{7}{8}$	$3\frac{3}{16}$	$2\frac{5}{16}$
6CK5	T-6½	8-Pin Miniature	$\frac{7}{8}$	$2\frac{31}{32}$	$2\frac{23}{32}$
6CL5	T-12	Octal	$1\frac{9}{16}$	5	$4\frac{7}{16}$
6CN6	—	Octal	$1\frac{25}{32}$	$5\frac{17}{32}$	5
6CT7	T-6½	8-Pin Miniature	$\frac{7}{8}$	2½	$2\frac{1}{16}$
6CU6	T-11 or T-12	Octal	$1\frac{7}{16}$ $1\frac{9}{16}$	$4\frac{1}{4}$ $4\frac{1}{4}$	$3\frac{11}{16}$ $3\frac{1}{16}$
6CU7	T-6½	8-Pin Miniature	$\frac{7}{8}$	2½	$2\frac{1}{16}$
6CV7	T-6½	8-Pin Miniature	$\frac{7}{8}$	2½	$2\frac{1}{16}$
6DA6	T-6½	9-Pin Miniature	$\frac{7}{8}$	$2\frac{13}{32}$	$2\frac{5}{32}$
6DN6	T-12	Octal	$1\frac{9}{16}$	5	$4\frac{7}{16}$
6DQ6	T-12	Octal	$1\frac{9}{16}$	$4\frac{1}{4}$	$3\frac{3}{4}$
6DQ6-A	T-12	Octal	$1\frac{9}{16}$	$4\frac{1}{4}$	$3\frac{1}{16}$
6DR6	—	9-Pin Miniature	0.945	3.16	2.91
6L6-GB	T-12	Octal	$1\frac{9}{16}$	$4\frac{3}{8}$	$3\frac{3}{16}$
6M3	T-12	Octal	$1\frac{9}{16}$	$4\frac{7}{8}$	$4\frac{5}{16}$
6S2	T-6½	9-Pin Miniature	$\frac{7}{8}$	2.913	2.658
6S2-A	T-6½	9-Pin Miniature	$\frac{7}{8}$	2.913	2.658
6V3-A	T-6½	9-Pin Miniature	$\frac{7}{8}$	$3\frac{1}{16}$	$2\frac{3}{4}$
6W2	T-5½	Special-FL*	$\frac{3}{4}$	$2\frac{9}{16}$	—
6X2	—	Special-FL*	0.571	2.087	—
6Y6-GA	T-12	Octal	$1\frac{9}{16}$	$3\frac{7}{8}$	$3\frac{5}{16}$
10	ST-16	4-Pin	$2\frac{1}{16}$	5½	$4\frac{3}{4}$
12AC5	T-6½	8-Pin Miniature	$\frac{7}{8}$	2½	$2\frac{1}{16}$
12AV5-GA	T-11 or T-12	Octal	$1\frac{7}{16}$ $1\frac{9}{16}$	4 4	$3\frac{7}{16}$ $3\frac{1}{16}$
12BQ6-GA	T-11 or T-12	Octal	$1\frac{7}{16}$ $1\frac{9}{16}$	$4\frac{1}{4}$ $4\frac{1}{4}$	$3\frac{11}{16}$ $3\frac{1}{16}$
12CU6	T-11 or T-12	Octal	$1\frac{7}{16}$ $1\frac{9}{16}$	$4\frac{1}{4}$ $4\frac{1}{4}$	$3\frac{11}{16}$ $3\frac{1}{16}$
12DQ6	T-12	Octal	$1\frac{9}{16}$	$4\frac{1}{4}$	$3\frac{3}{4}$
12DQ6-A	T-12	Octal	$1\frac{9}{16}$	$4\frac{1}{4}$	$3\frac{1}{16}$
12S7	T-6½	8-Pin Miniature	$\frac{7}{8}$	2½	$2\frac{1}{16}$

\*FL—Flying Leads  
SL—Short Leads

## Not Conforming to Standard Outline Drawings

Tube Type	Envelope	Style	Max Dimensions in Inches		
			Diameter	Over-all Length	Seated Height
14K7	T-6½	8-Pin Miniature	⅞	2⅜	2 ⅛
14L7	T-6½	8-Pin Miniature	⅞	2⅜	2 ⅛
17AV5-GA	T-11 or T-12	Octal	1 7/16 1 9/16	4	3 7/16 3 7/16
17DQ6	T-12	Octal	1 9/16	4 ¼	3 ¾
17Z3	T-6½	9-Pin Miniature	⅞	3 3/16	2 5/16
19BG6-GA	T-12	Octal	1 9/16	5	4 7/16
21A6	T-6½	9-Pin Miniature	⅞	3 3/16	2 5/16
21B6	—	9-Pin Miniature	0.945	3.16	2.91
25AV5-GA	T-11 or T-12	Octal	1 7/16 1 9/16	4 4	3 7/16 3 7/16
25BQ6-GA	T-11 or T-12	Octal	1 7/16 1 9/16	4 ¼ 4 ¼	3 1/16 3 1/16
25C6-GA	T-12	Octal	1 9/16	4 5/8	4 1/16
25CD6-GB	T-12	Octal	1 9/16	5	5 7/16
25CU6	T-11 or T-12	Octal	1 7/16 1 9/16	4 1/2 4 ¼	3 1/16 3 1/16
25DN6	T-12	Octal	1 9/16	5	4 7/16
25DQ6	T-12	Octal	1 9/16	4 ¼	3 ¾
25E5	T-9	Octal	1 9/32	4 5/16	3 ¾
26E6-G	T-11	Octal	1 7/16	3 3/8	2 9/16
35CD6-GA	T-12	Octal	1 9/16	5	4 7/16
45A5	T-6½	8-Pin Miniature	⅞	2 3/32	2 23/32
50	ST-19	4-Pin	2 7/16	6 ¼	5 5/8
50C6-GA	T-12	Octal	1 9/16	4 5/8	4 1/16
81	ST-19	4-Pin	2 7/16	6 ¼	5 5/8
V-99	T-8	Special	1 1/16	3 1/2	—
1629	T-9	Octal	1 3/16	4 1/8	3 7/16
1654	T-5½	7-Pin Miniature	¾	2 7/16	2 3/16
5633	T-3	Special Subm-FL*	0.400	—	1.660
5634	T-3	Special Subm-FL*	0.400	—	1.660
5642	T-3	Special Subm-FL*	0.400	—	2.380
5645	T-2	Special Subm-FL*	0.310	—	1.300
5646	T-2	Special Subm-FL*	0.310	—	1.300
5647	T-1	Special Subm-FL*	0.215	—	1.250

\*FL—Flying Leads

SL—Short Leads

## T-X TABLE—Physical Characteristics of Types

Tube Type	Envelope	Style	Max Dimensions in Inches		
			Diameter	Over-all Length	Seated Height
5675	—	Pencil Type	—	2.108	—
5676	T-2 x 3	Inline Subm-FL*	0.400 x 0.300	—	1.500
5677	T-2 x 3	Inline Subm-FL*	0.400 x 0.300	—	1.500
5678	T-2 x 3	Inline Subm-FL*	0.400 x 0.300	—	1.515
5690	T-12	Octal	1 $\frac{3}{32}$	4 $\frac{1}{4}$	3 $\frac{11}{16}$
5704	T-2	Inline Subm-FL*	0.315	—	1 $\frac{1}{2}$
5785	T-2 x 3	Inline Subm-FL*	0.400 x 0.300	—	1.500
5825	ST-16	4-Pin	2 $\frac{1}{16}$	5 $\frac{27}{32}$	5 $\frac{7}{32}$
5838	T-9	Octal	1 $\frac{5}{16}$	3 $\frac{3}{8}$	2 $\frac{7}{8}$
5839	T-9	Octal	1 $\frac{5}{16}$	3 $\frac{3}{8}$	2 $\frac{7}{8}$
5851	T-3	Button Subm-FL*	0.400	—	1.600
5852	T-9	Octal	1 $\frac{5}{16}$	3 $\frac{3}{8}$	2 $\frac{7}{8}$
5876	—	Pencil Type	—	2.108	—
5881	T-11	Octal	1 $\frac{7}{16}$	3 $\frac{15}{16}$	2 $\frac{29}{32}$
5890	T-11	Duodecal	1 $\frac{1}{2}$	6 $\frac{3}{4}$	6 $\frac{1}{4}$
5930	T-12	4-Pin	1.70	4 $\frac{1}{2}$	3 $\frac{7}{8}$
5931	T-12	Octal	1.70	4 $\frac{29}{32}$	4 $\frac{11}{32}$
5932	T-12	Octal	1.70	3 $\frac{27}{32}$	3 $\frac{9}{32}$
5995	T-3	Inline Subm-FL*	0.400	—	1.75
6004	T-9	Octal	1 $\frac{5}{16}$	4 $\frac{1}{16}$	—
6007	T-2	Special Subm-FL*	0.322	—	1.417
6008	T-2	Special Subm-FL*	0.322	—	1.102
6080	T-12	Octal	1 $\frac{3}{32}$	4 $\frac{1}{16}$	3 $\frac{1}{2}$
6082	T-12	Octal	1 $\frac{3}{32}$	4 $\frac{1}{16}$	3 $\frac{1}{2}$
6094	T-6 $\frac{1}{2}$	9-Pin Miniature	$\frac{7}{8}$	3	2 $\frac{3}{4}$
6106	T-9	Octal	1.320	3.375	2.880

\*FL—Flying Leads  
SL—Short Leads

## Not Conforming to Standard Outline Drawings

Tube Type	Envelope	Style	Max Dimensions in Inches		
			Diameter	Over-all Length	Seated Height
6173	—	Pencil Type	—	1.987	—
6184	T-3	Button Subm-FL*	0.400	—	1.25
6195	T-3	Button Subm-FL*	0.400	—	1.60
6215	T-9	Octal	1 <sup>9</sup> / <sub>32</sub>	4 <sup>1</sup> / <sub>16</sub>	3 <sup>1</sup> / <sub>2</sub>
6287	T-6 <sup>1</sup> / <sub>2</sub>	9-Pin Miniature	<sup>7</sup> / <sub>8</sub>	2.47	—
6305	T-5 <sup>1</sup> / <sub>2</sub>	7-Pin Miniature	<sup>3</sup> / <sub>4</sub>	2 <sup>9</sup> / <sub>32</sub>	2 <sup>1</sup> / <sub>32</sub>
6320	T-3	Button Subm-FL*	0.400	—	1.125
6321	T-3	Button Subm-FL*	0.400	—	1.125
6325	T-9	Octal	1 <sup>9</sup> / <sub>32</sub>	—	2 <sup>3</sup> / <sub>8</sub>
6327	T-12	Octal	1 <sup>3</sup> / <sub>4</sub>	4 <sup>1</sup> / <sub>2</sub>	3 <sup>5</sup> / <sub>16</sub>
6355	T-5 <sup>1</sup> / <sub>2</sub>	7-Pin Miniature	0.750	1.531	1.250
6374	T-6 <sup>1</sup> / <sub>2</sub>	9-Pin Miniature	<sup>7</sup> / <sub>8</sub>	3 <sup>3</sup> / <sub>16</sub>	2 <sup>5</sup> / <sub>16</sub>
6384	T-11	Octal	1 <sup>7</sup> / <sub>16</sub>	3 <sup>15</sup> / <sub>32</sub>	2 <sup>5</sup> / <sub>16</sub>
6391	T-3	Special Subm-FL*	0.4	—	1 <sup>1</sup> / <sub>2</sub>
6397	T-3	Button Subm-FL*	0.400	—	1.60
6443	T-6 <sup>1</sup> / <sub>2</sub>	9-Pin Miniature	<sup>7</sup> / <sub>8</sub>	3 <sup>9</sup> / <sub>32</sub>	3
6489	—	Special Subm-FL*	<sup>7</sup> / <sub>32</sub>	—	1.12
6519	T-1 <sup>1</sup> / <sub>2</sub> x 2	Inline Subm-FL*	0.290 x 0.220	—	1.25
6550	ST-16	Octal	2 <sup>1</sup> / <sub>16</sub>	4 <sup>3</sup> / <sub>4</sub>	4 <sup>3</sup> / <sub>16</sub>
6690	T-3	Button Subm-FL*	0.400	—	1.000
6754	T-6 <sup>1</sup> / <sub>2</sub>	9-Pin Miniature	<sup>7</sup> / <sub>8</sub>	2 <sup>3</sup> / <sub>4</sub>	2 <sup>1</sup> / <sub>2</sub>
6760	T-6 <sup>1</sup> / <sub>2</sub>	9-Pin Miniature	<sup>7</sup> / <sub>8</sub>	2 <sup>3</sup> / <sub>4</sub>	2 <sup>1</sup> / <sub>2</sub>
6761	T-6 <sup>1</sup> / <sub>2</sub>	9-Pin Miniature	<sup>7</sup> / <sub>8</sub>	2 <sup>3</sup> / <sub>4</sub>	2 <sup>1</sup> / <sub>2</sub>
6788	T-3	Button Subm-FL*	0.400	—	1.250
6792	T-12	Octal	1 <sup>23</sup> / <sub>32</sub>	5 <sup>1</sup> / <sub>16</sub>	4 <sup>1</sup> / <sub>32</sub>
6842	T-5 <sup>1</sup> / <sub>2</sub>	7-Pin Miniature	<sup>3</sup> / <sub>4</sub>	2 <sup>1</sup> / <sub>4</sub>	2

\*FL—Flying Leads  
SL—Short Leads

## 5U4-GB RATING CHART I

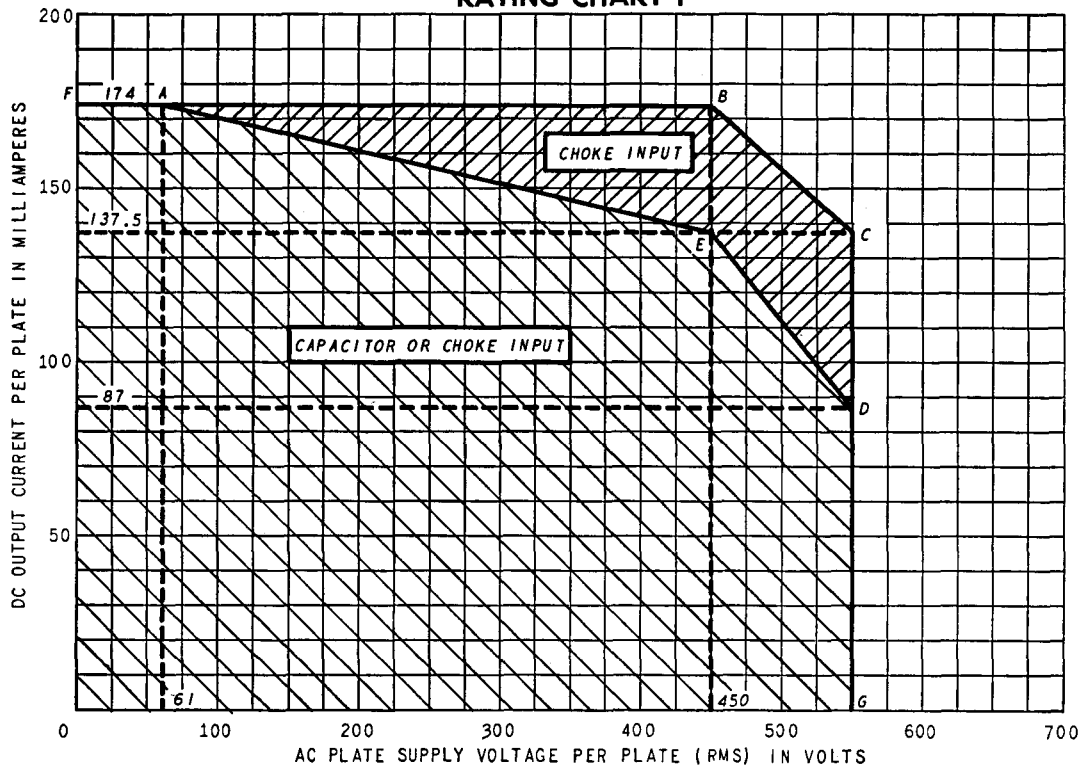

**With a capacitor-input filter, the operating point of d-c output current and a-c supply voltage must fall within the curve FAEDG. With a choke-input filter, the operating point must fall within the curve FABCDG.**



# 5U4-GB

## OPERATION CHARACTERISTICS

FULL-WAVE RECTIFIER WITH CAPACITOR-INPUT FILTER

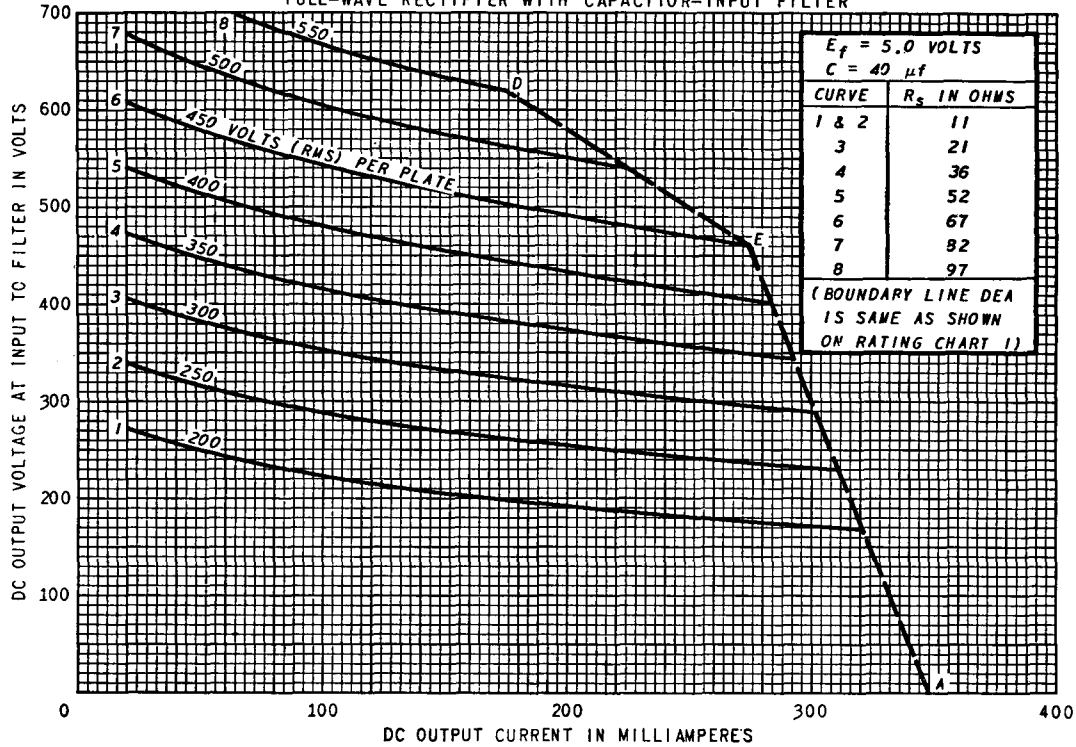

# 6AQ5, 5AQ5, 12AQ5, 6AQ5-A, 5V6-GT, 6V6-GT, 12V6-GT, 6V6-GTA

## AVERAGE PLATE CHARACTERISTICS

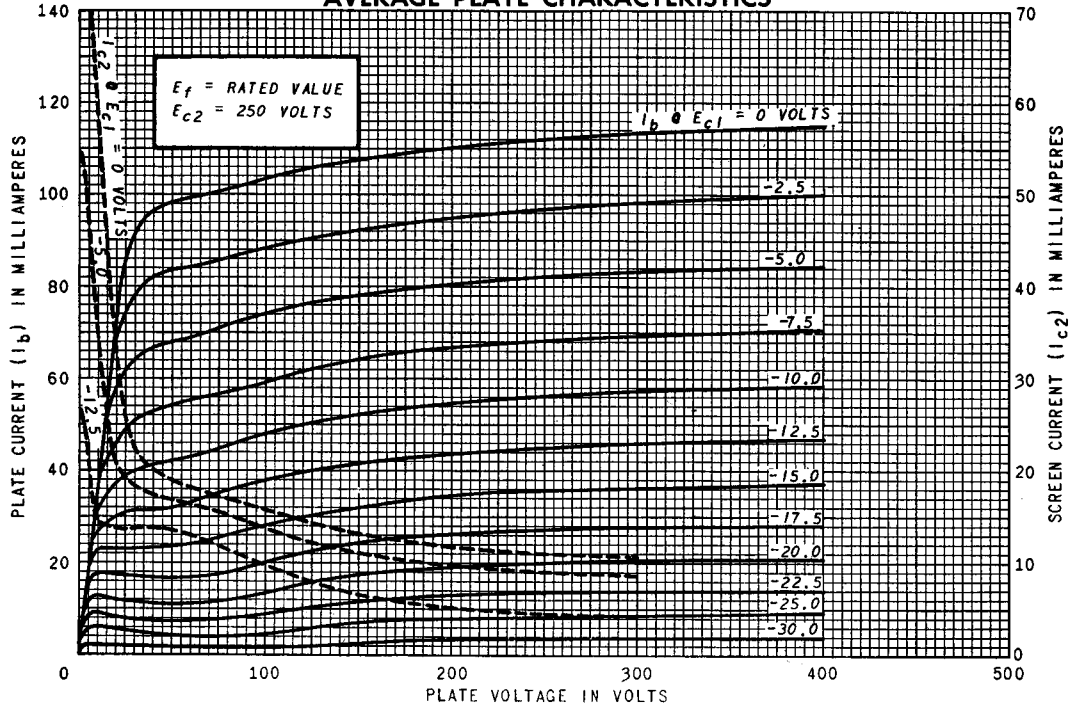

# 6AU6, 3AU6, 4AU6, 12AU6, 6AU6-A

## AVERAGE PLATE CHARACTERISTICS

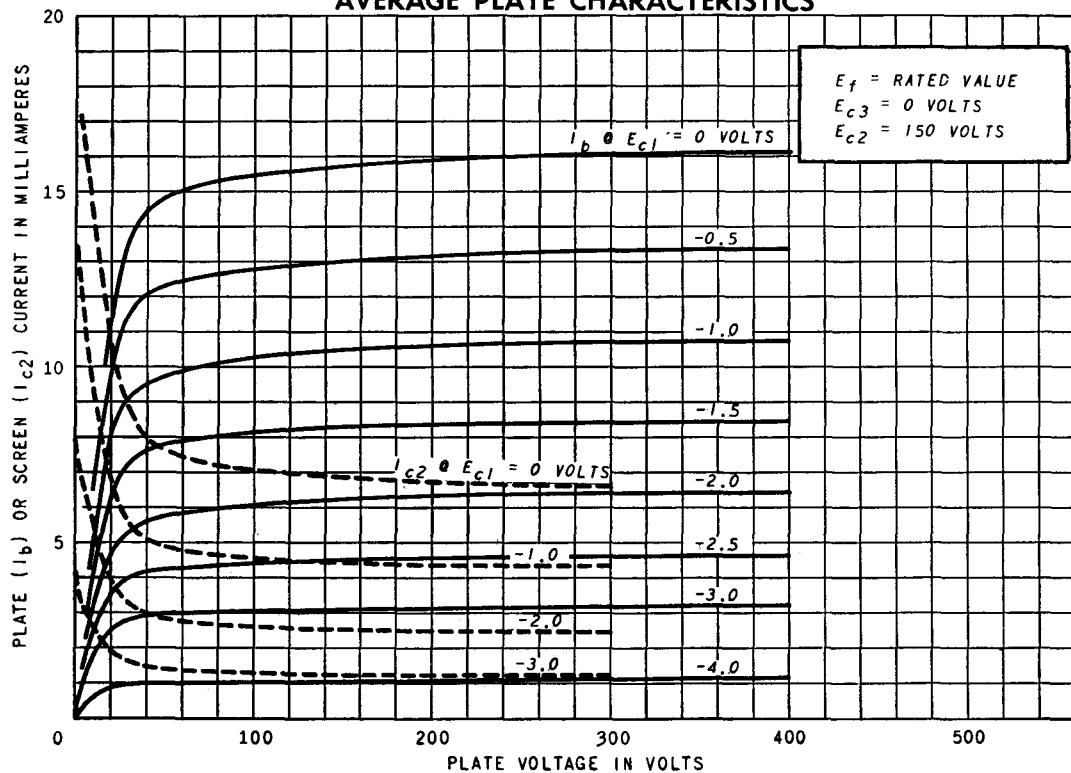

## 6BA6, 3BA6, 4BA6, 12BA6

### AVERAGE PLATE CHARACTERISTICS

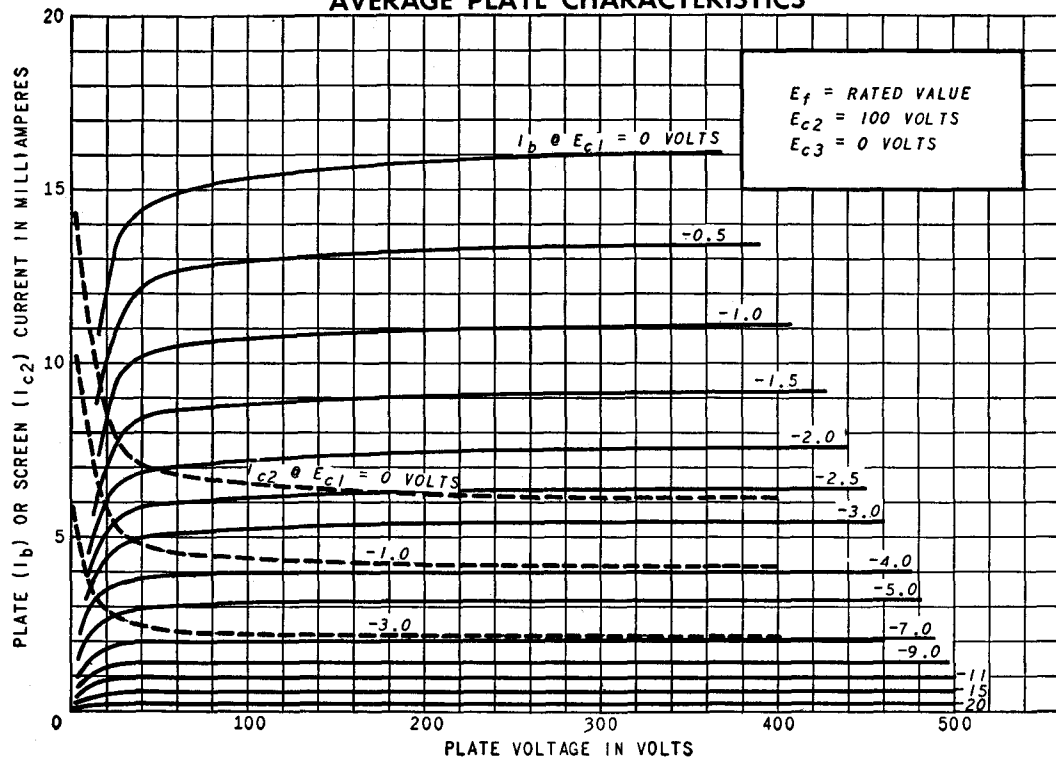

**6BQ6-GA, 12BQ6-GA, 25BQ6-GA, 6CU6, 12CU6, 25CU6, 6AV5-GA,  
12AV5-GA, 17AV5-GA, 25AV5-GA**

**AVERAGE PLATE CHARACTERISTICS**

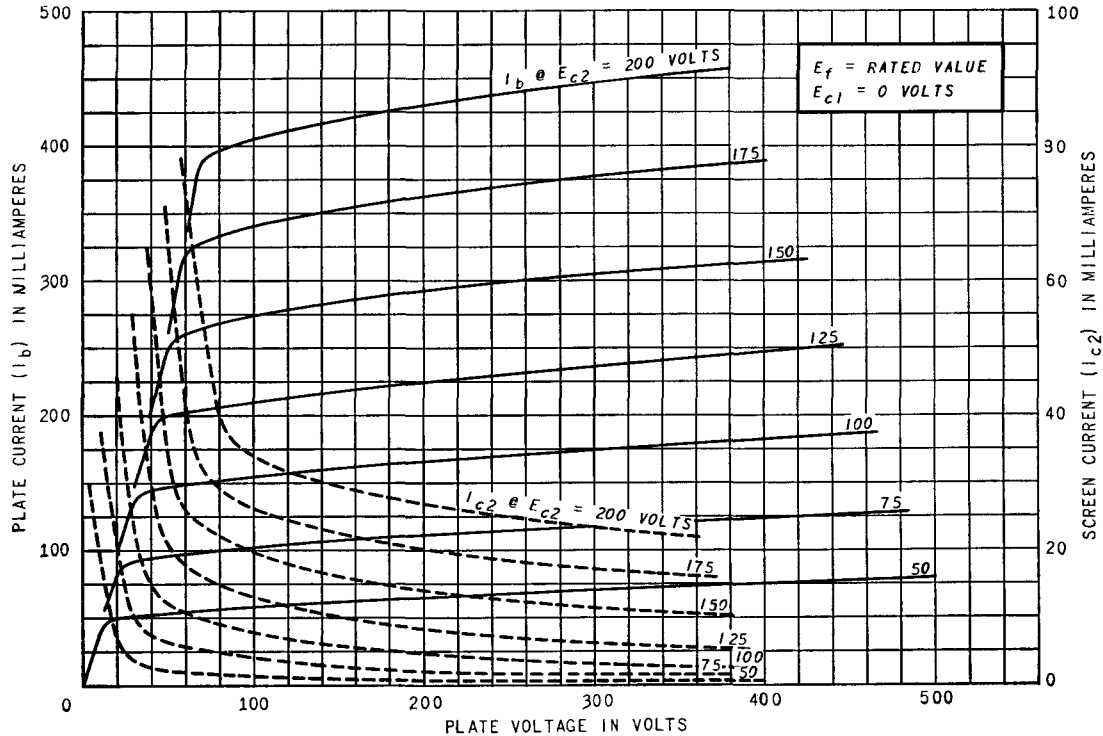

## 6CB6, 3CB6, 4CB6, 6CB6-A

### AVERAGE PLATE CHARACTERISTICS

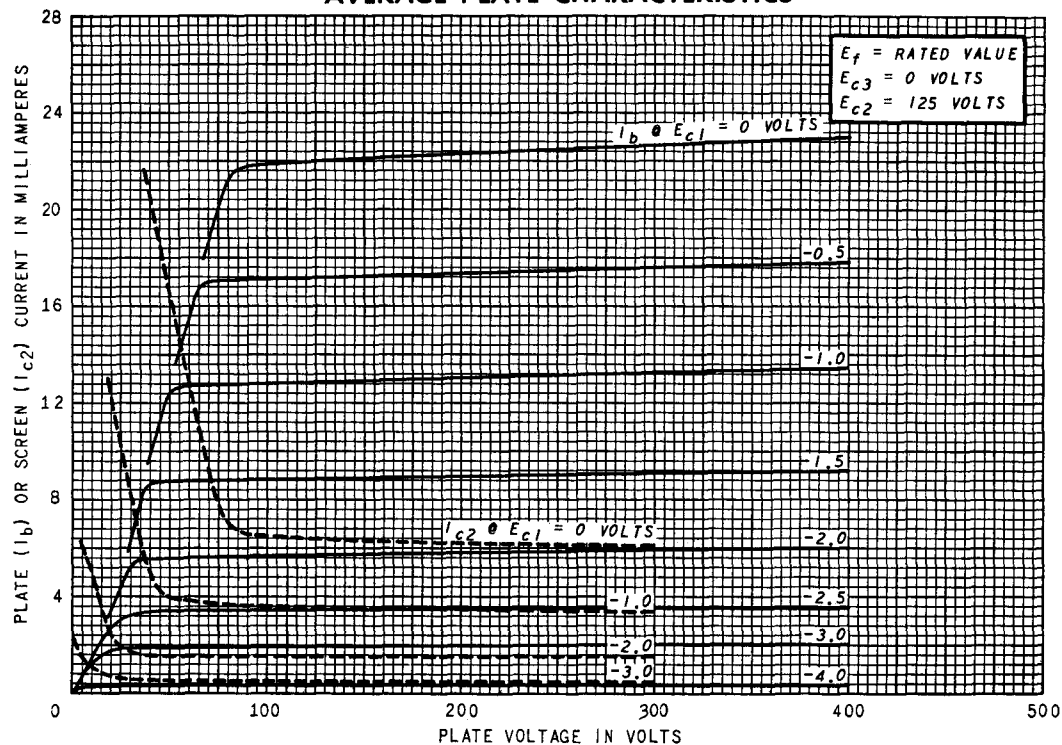

# 6CB6, 3CB6, 4CB6, 6CB6-A AVERAGE TRANSFER CHARACTERISTICS

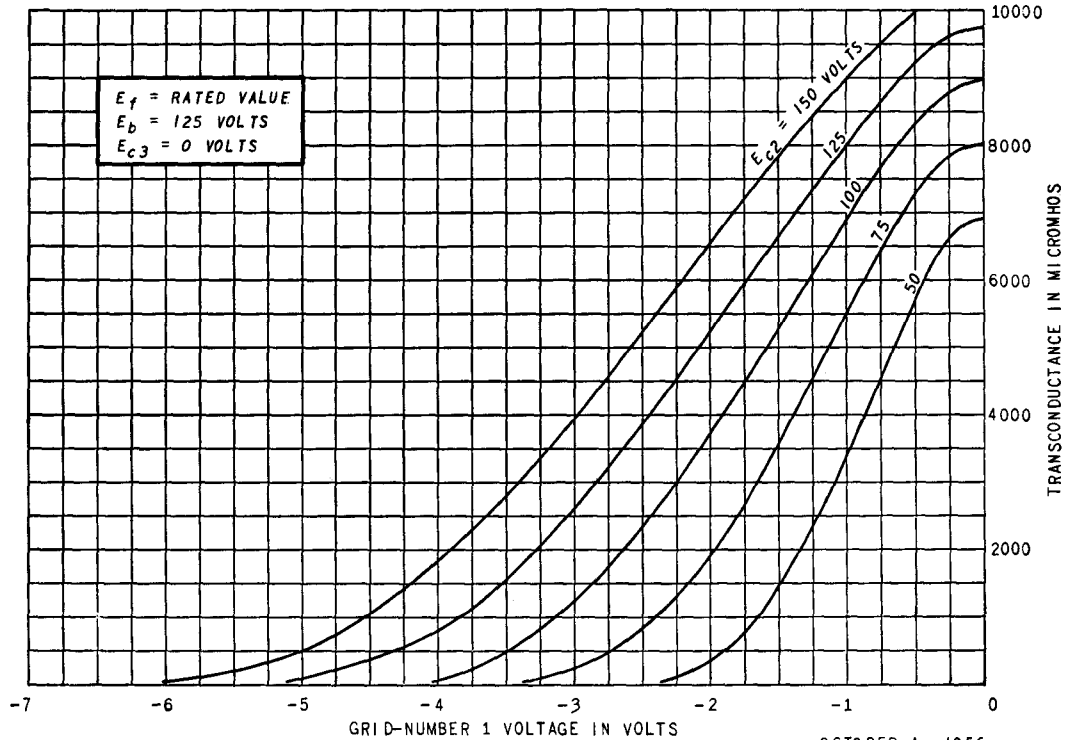

OCTOBER 4, 1956

# 6SN7-GTB, 6SN7-GTA, 12SN7-GTA, 6SN7-GT, 12SN7-GT, 6CG7, 8CG7

## AVERAGE PLATE CHARACTERISTICS

EACH SECTION

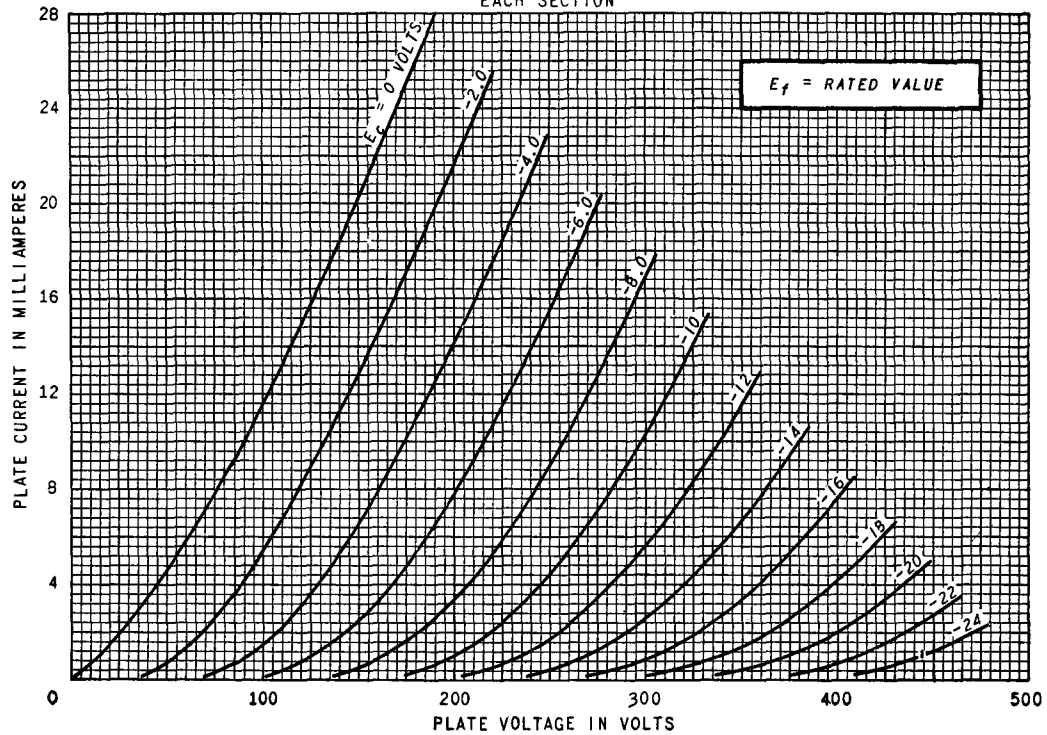



**6SN7-GTB, 6SN7-GTA, 12SN7-GTA, 6SN7-GT, 12SN7-GT 6CG7, 8CG7**

**AVERAGE CHARACTERISTICS**

EACH SECTION

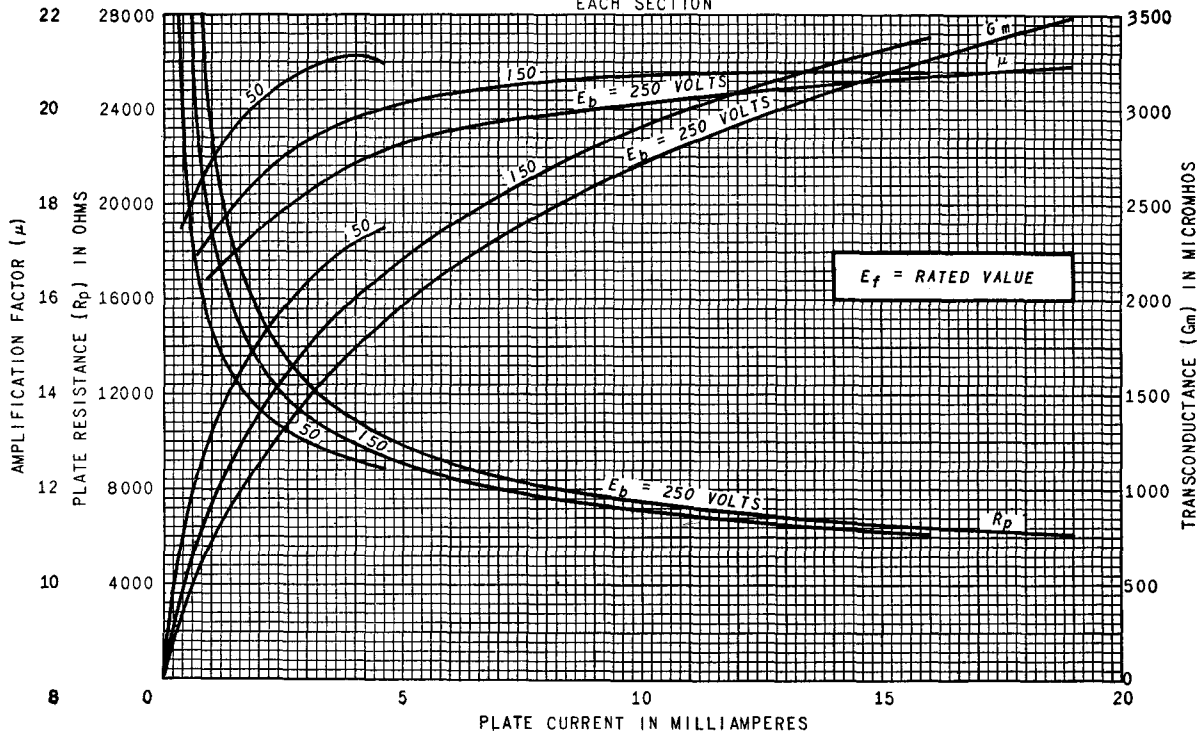

# 12AU7, 7AU7, 12AU7-A

## AVERAGE PLATE CHARACTERISTICS

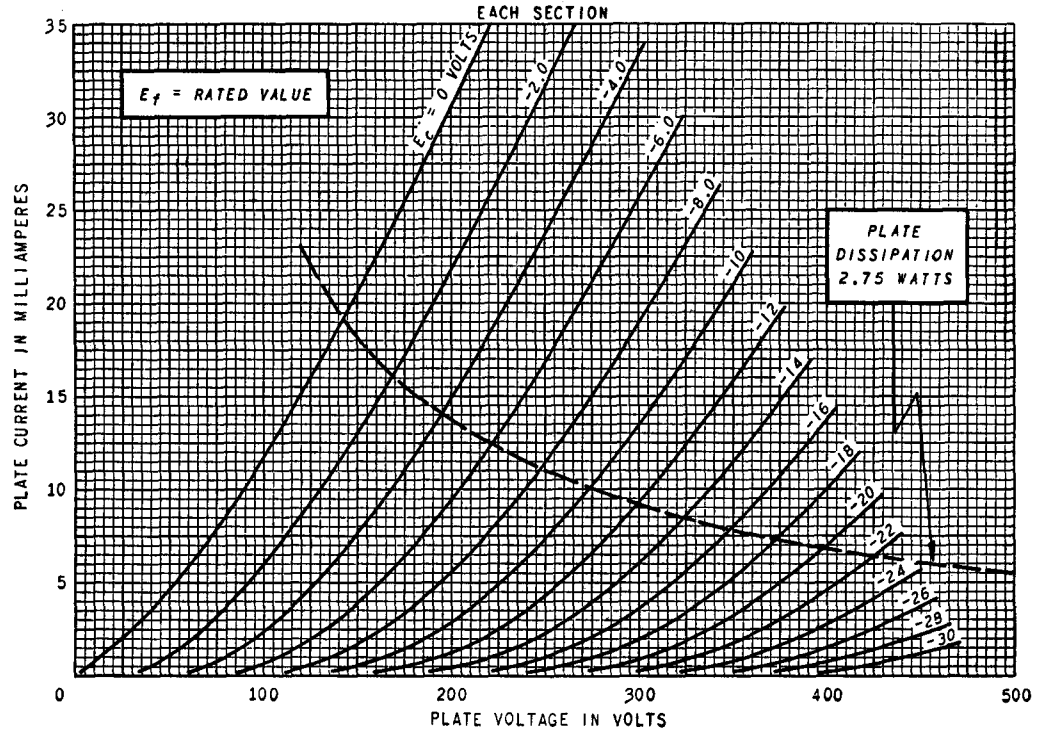

# 12AX7

## AVERAGE PLATE CHARACTERISTICS

EACH SECTION

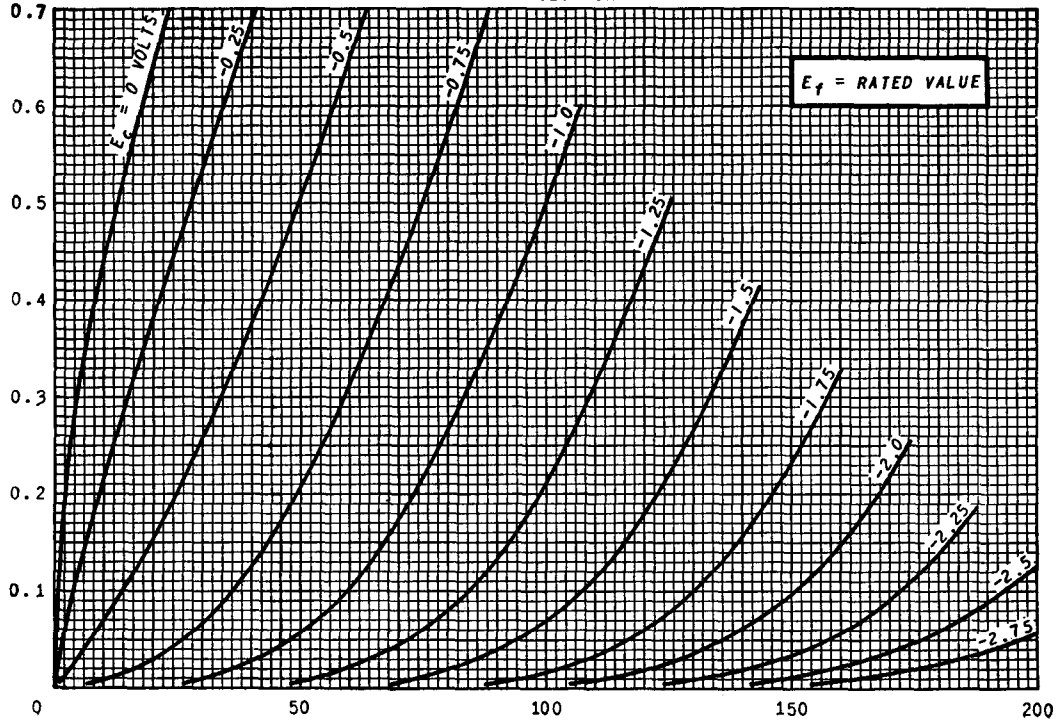

### **CIRCUIT DIAGRAMS**

These circuit diagrams are included for illustration of typical tube applications and are not intended as constructional information. For this reason, wattage ratings of resistors and voltage ratings of capacitors are not necessarily given. Similarly, shielding techniques and alignment methods which may be necessary in some circuit layouts are not indicated.

The description and illustration of the circuits contained herein does not convey to the purchaser of tubes any license under patent rights of General Electric Company. Although reasonable care has been taken in their preparation to assure their technical correctness, no responsibility is assumed by General Electric Company for any consequences of their use.

## AC/DC RECEIVER

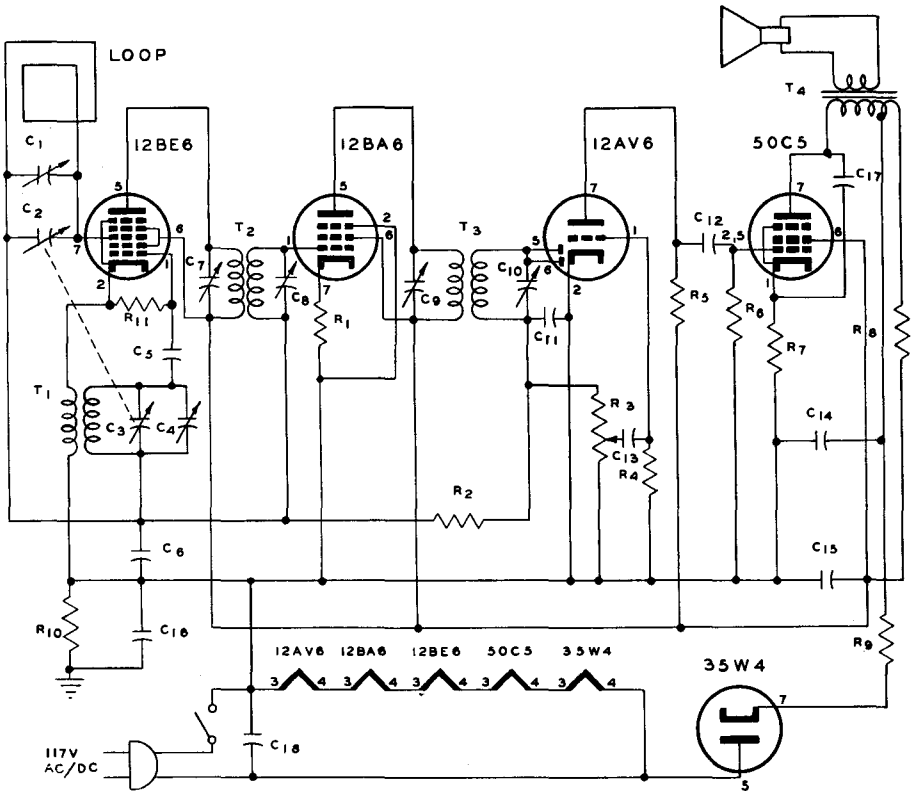

- C<sub>1</sub>—1-15  $\mu\text{f}$  Trimmer  
 C<sub>2</sub> C<sub>3</sub>—Ganged 14-434  $\mu\text{f}$  and 9-135  $\mu\text{f}$   
 C<sub>4</sub>—1.5-15  $\mu\text{f}$  Trimmer  
 C<sub>5</sub>—47  $\mu\text{f}$   
 C<sub>6</sub> C<sub>18</sub>—0.05  $\mu\text{f}$   
 C<sub>7</sub> C<sub>8</sub> C<sub>9</sub> C<sub>10</sub>—60-140  $\mu\text{f}$   
 C<sub>11</sub>—220  $\mu\text{f}$   
 C<sub>12</sub> C<sub>13</sub> C<sub>16</sub>—0.01  $\mu\text{f}$   
 C<sub>14</sub> C<sub>15</sub>—50  $\mu\text{f}$  150V  
 C<sub>17</sub>—0.005  $\mu\text{f}$   
 T<sub>1</sub>—Oscillator Transformer  
 T<sub>2</sub> T<sub>3</sub>—IF Transformer 455 KC  
 T<sub>4</sub>—2500 $\Omega$  to 3.4 $\Omega$  Output Transformer  
 (With Hum-bucking Tap)

All Resistors  $\frac{1}{2}$  Watt Unless Otherwise Specified

- R<sub>1</sub>—47 $\Omega$   
 R<sub>2</sub>—2.2 Meg  
 R<sub>3</sub>—0.5 Meg Pot.  
 R<sub>4</sub>—6.8 Meg  
 R<sub>5</sub> R<sub>6</sub> R<sub>10</sub>—0.47 Meg  
 R<sub>7</sub>—150 $\Omega$  1 Watt  
 R<sub>8</sub>—1000 $\Omega$  2 Watt  
 R<sub>9</sub>—22 $\Omega$  1 Watt  
 R<sub>11</sub>—22 K

## AC/DC AMPLIFIER

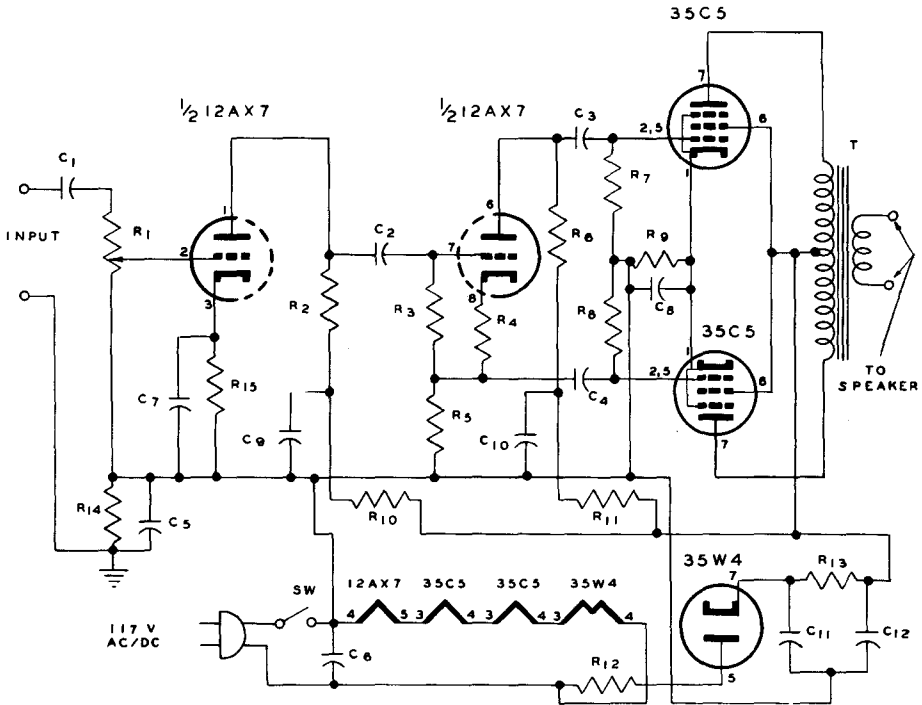

$R_1$ —0.5 Meg Pot.

$R_2$ —0.24 Meg

$R_3$ —0.24 Meg  $\frac{1}{2}$  Watt

$R_4$ —1200 $\Omega$

$R_5$   $R_6$ —47 K

$R_7$   $R_8$   $R_{14}$ —0.47 Meg  $\frac{1}{2}$  Watt

$R_9$ —100 $\Omega$  5 Watt

$R_{10}$   $R_{11}$ —33 K

$R_{12}$   $R_{13}$ —47 $\Omega$

$R_{15}$ —2700 $\Omega$

$C_1$   $C_2$   $C_3$   $C_4$   $C_6$ —0.05  $\mu$ f 400V

$C_5$ —0.01  $\mu$ f 600V

$C_7$ —25  $\mu$ f 25V

$C_8$ —50  $\mu$ f 25V

$C_9$ —8  $\mu$ f 150V

$C_{10}$ —8  $\mu$ f 150V

$C_{11}$ —20  $\mu$ f 150V

$C_{12}$ —80  $\mu$ f 150V

T—Output Transformer 5000 $\Omega$  CT to Voice Coil

SW—SPST Toggle Switch

SW should not be mounted on the back of  $R_1$ . This precaution will reduce hum.

All Resistors 1 Watt Unless Otherwise Specified

## PHONO PREAMPLIFIER FOR VARIABLE RELUCTANCE CARTRIDGE

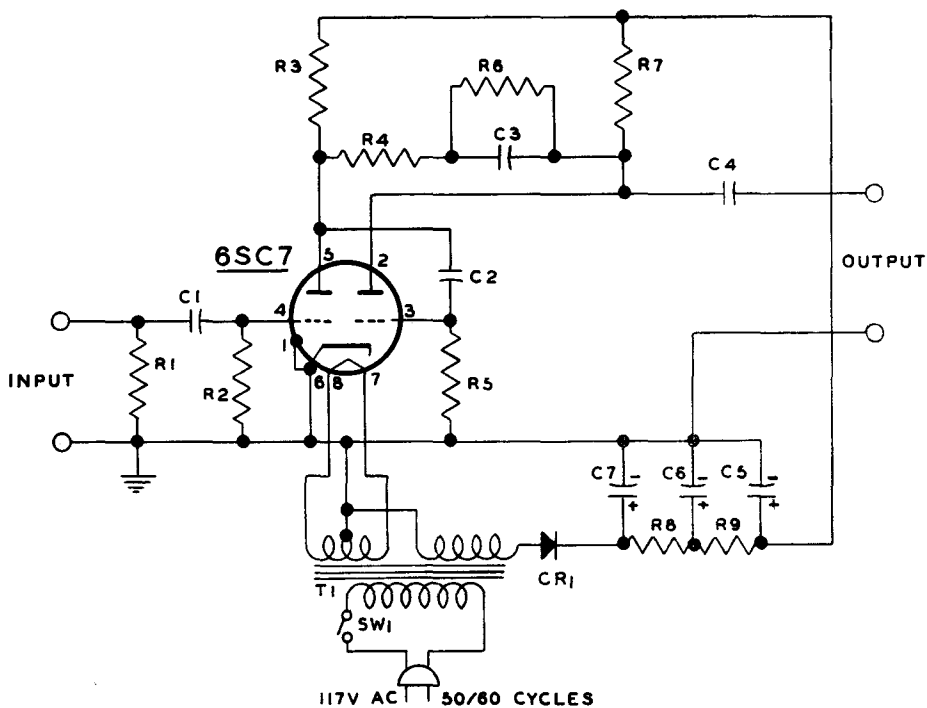

C1 C2 C4—	0.05 $\mu$ f 400V
C3—	0.0082 $\mu$ f 400V
C5 C6—	15 $\mu$ f 150V
C7—	30 $\mu$ f 150V
CR1	Selenium Rectifier 150V, 5 Ma
R1—	See Note
R2 R5	3.3 Meg
R3—	68 K
R4—	39 K
R6—	910 K $\pm$ 5%
R7—	47 K
R8 R9—	22 K
SW1—	On-Off Switch
T1—	Power Transformer: Pri—117V, 60CY Sec—120V, 5 Ma; 6.3V, 0.3A

Note: Resistor R1 may be varied from 4.7 K (minimum) to 47 K to increase the high-frequency response. To obtain standard (RIAA) rolloff, R1 should be 6.2 K.

All Resistors  $\frac{1}{2}$  Watt

## THREE-TUBE PHONO-AMPLIFIER

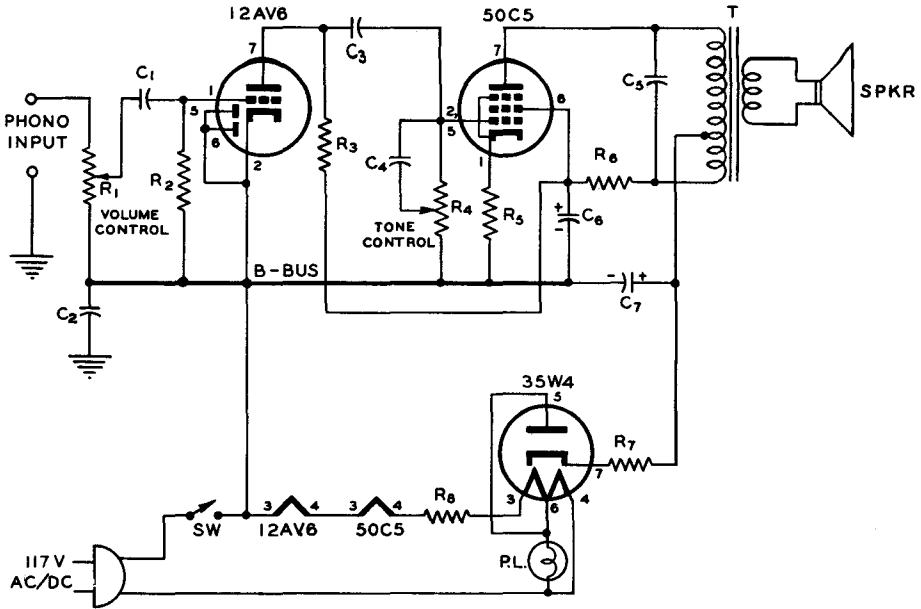

- $C_1$ —0.002  $\mu$ f 400V  
 $C_2$ —0.05  $\mu$ f 400V  
 $C_3$ —0.01  $\mu$ f 400V  
 $C_4$ —0.005  $\mu$ f 400V  
 $C_5$ —0.022  $\mu$ f 400V  
 $C_6$   $C_7$ —50  $\mu$ f 150V  
 $R_1$   $R_4$ —0.5 Meg Pot.  
 $R_2$ —6.8 Meg  
 $R_3$ —470 K  
 $R_5$ —150 $\Omega$  1 Watt  
 $R_6$ —6.8 K  
 $R_7$ —33 $\Omega$   
 $R_8$ —120 $\Omega$  5 Watt

- T—Output Transformer 2500 $\Omega$  to Voice Coil  
 (With Hum-bucking Tap)  
 PL—No. 47 Pilot Lamp  
 SW—On-Off Switch

All Resistors  $\frac{1}{2}$  Watt Unless Otherwise Specified



## REGULATED POWER SUPPLY

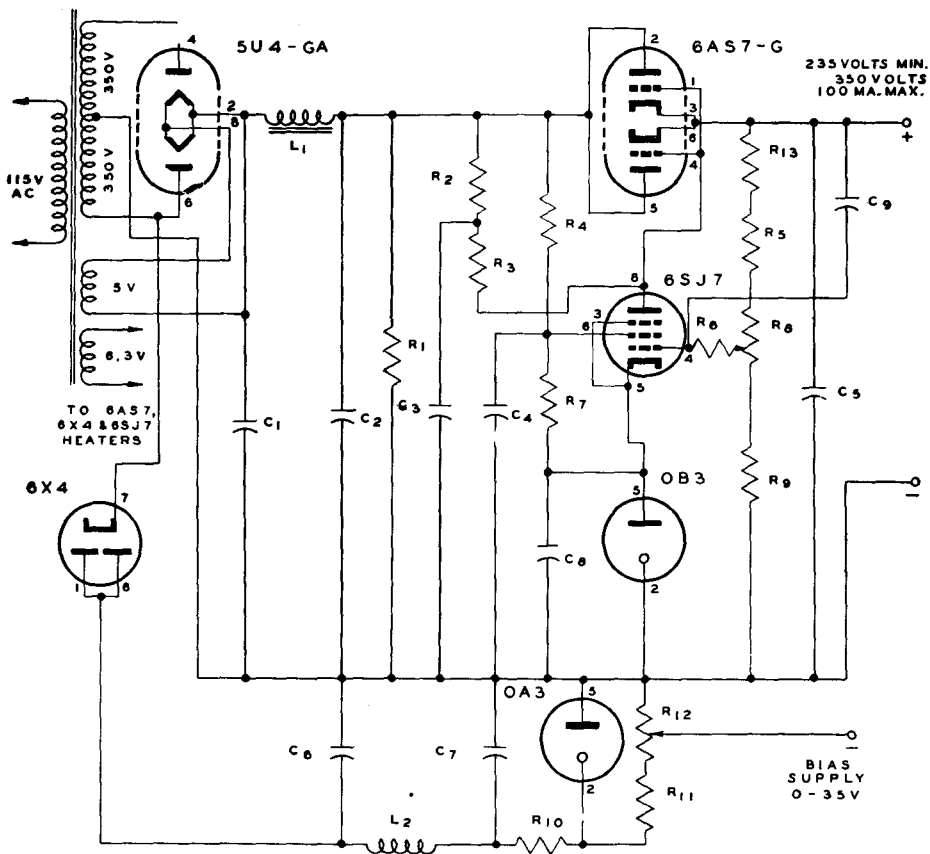

$C_1$   $C_2$ —16  $\mu$ f 600V  
 $C_3$   $C_4$ —1  $\mu$ f 600V  
 $C_5$ —8  $\mu$ f 450V  
 $C_6$ —4  $\mu$ f 600V  
 $C_7$   $C_8$ —40  $\mu$ f 450V  
 $C_9$ —0.1  $\mu$ f 600V

$R_1$ —0.47 Meg  
 $R_2$   $R_9$   $R_{13}$ —0.33 Meg  
 $R_3$ —0.1 Meg  
 $R_4$ —20 K 10 Watt  
 $R_5$   $R_6$ —1 Meg  
 $R_7$ —10 K 10 Watt  
 $R_8$ —0.5 Meg Pot.  
 $R_{10}$ —20 K 5 Watt  
 $R_{11}$ —5 K 5 Watt

$R_{12}$ —5 K Pot. (5 Watt)  
 $L_1$ —200 Ma 15 HY  
 $L_2$ —60 Ma 15 HY

All Resistors 1 Watt Unless Otherwise Specified

## INTERCOMMUNICATION AMPLIFIER

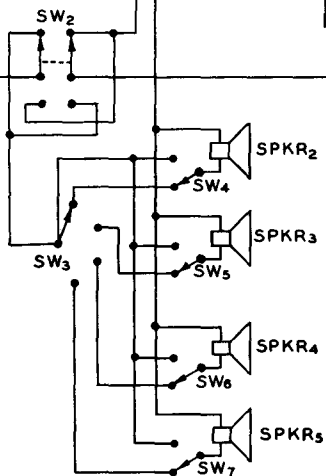
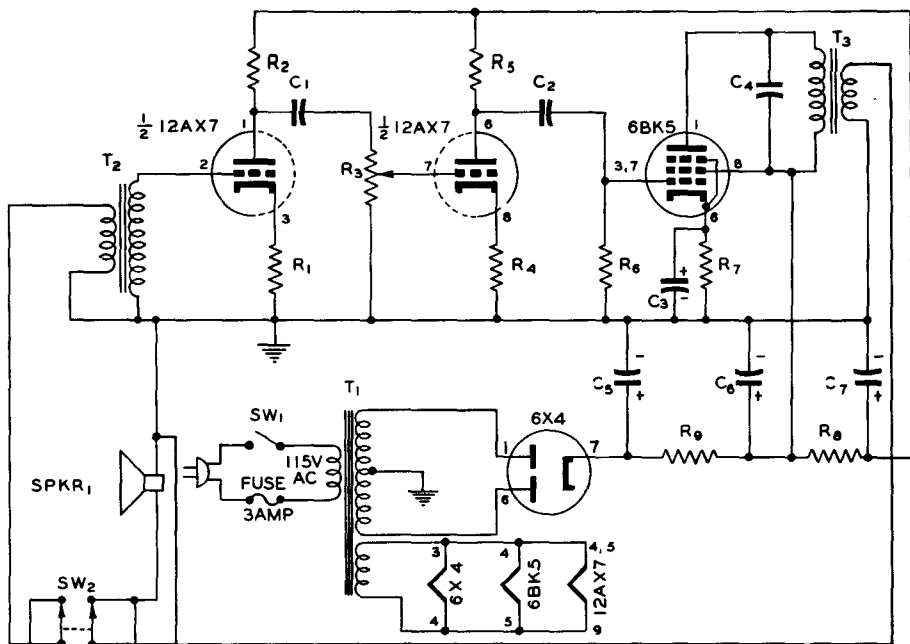

- R<sub>1</sub>—3300Ω
- R<sub>2</sub>—510 K
- R<sub>3</sub>—1 Meg Pot.
- R<sub>4</sub>—1000Ω
- R<sub>5</sub>—100 K
- R<sub>6</sub>—240 K
- R<sub>7</sub>—150Ω 1 Watt
- R<sub>8</sub>—22 K
- R<sub>9</sub>—450Ω 2 Watt
- C<sub>1</sub>—350 μμf
- C<sub>2</sub>—0.001 μf
- C<sub>3</sub>—25 μf
- C<sub>4</sub>—0.002 μf
- C<sub>5</sub> C<sub>6</sub> C<sub>7</sub>—10 μf

T<sub>1</sub>—Power Transformer: 250-0-250V, 40 Ma; 6.3V, 2.5A

T<sub>2</sub>—Input Transformer: 1 to 30 Turns Ratio

T<sub>3</sub>—Output Transformer: 6600Ω to Voice Coil

SW<sub>1</sub>—SPST On-Off Toggle Switch

SW<sub>2</sub>—DPDT Master Station Push-to-talk Switch

SW<sub>3</sub>—Station Selector Switch

SW<sub>4</sub> SW<sub>5</sub> SW<sub>6</sub> SW<sub>7</sub>—SPST Remote Speaker Push-to-talk Switch

SPKR<sub>1</sub>—Master Station PM Speaker

SPKR<sub>2</sub> SPKR<sub>3</sub> SPKR<sub>4</sub> SPKR<sub>5</sub>—Remote Station PM Speaker

All Resistors ½ Watt Unless Otherwise Specified

## PHONE—CW MONITOR AND CODE PRACTICE OSCILLATOR

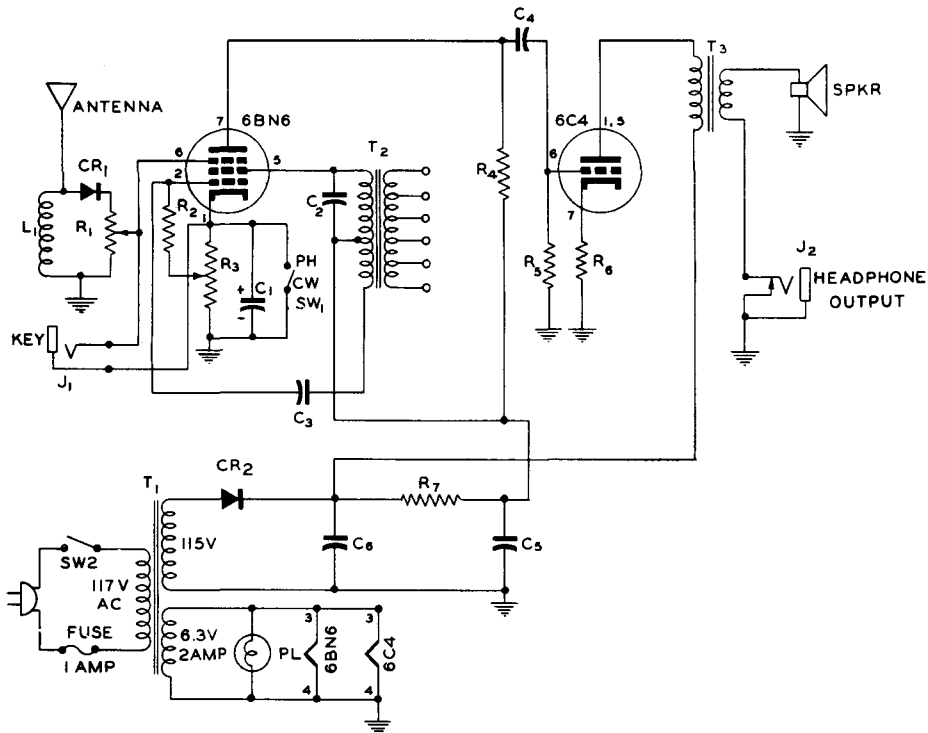

$R_1$ —200 K Pot.

$R_2$   $R_5$ —500 K

$R_3$ —500 $\Omega$  Pot.

$R_4$ —100 K

$R_6$ —1500 $\Omega$  1 Watt

$R_7$ —5600 $\Omega$  2 Watt

$L_1$ —8MH RF Choke

CR<sub>1</sub>—1N52 Diode

CR<sub>2</sub>—Selenium Rectifier 100MA DC

T<sub>1</sub>—Power Transformer: Sec—115V, 50Ma; 6.3V, 2A

T<sub>2</sub>—Universal Output Transformer Pri-4000 to 14,000 $\Omega$   
with Center Tap

T<sub>3</sub>—Output Transformer 10,000 $\Omega$  to Voice Coil

PL—6.3-Volt Pilot Lamp

J<sub>1</sub>—Open-circuit Phone Jack

J<sub>2</sub>—Short-circuit Phone Jack

SW<sub>1</sub>—SPST Phone—CW Toggle Switch

SW<sub>2</sub>—SPST On-off Toggle Switch

All Resistors  $\frac{1}{2}$  Watt Unless Otherwise Specified

$C_1$ —10  $\mu$ f 25V

$C_2$ —0.006  $\mu$ f 400V

$C_3$ —0.001  $\mu$ f 400V

$C_4$ —0.01  $\mu$ f 400V

$C_5$ —20  $\mu$ f 150V

$C_6$ —40  $\mu$ f 150V

## 6BK7-A CASCODE TELEVISION BOOSTER

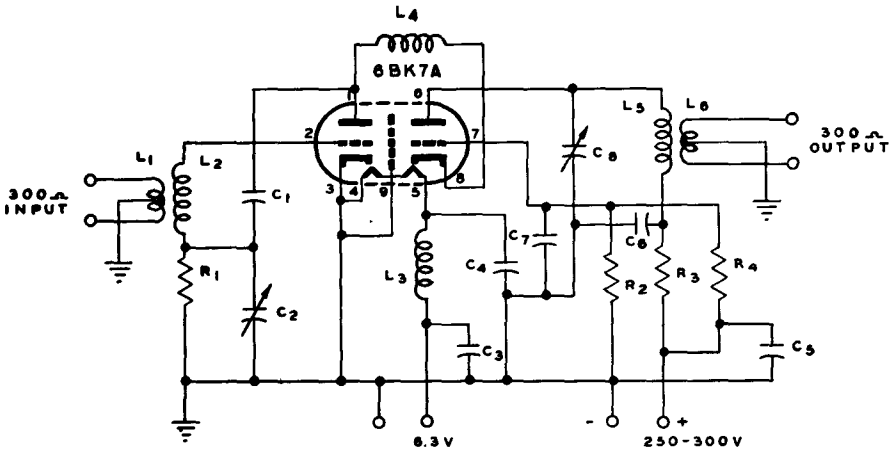

$C_1$ —4.7  $\mu\text{mf}$   
 $C_2$ —3–13  $\mu\text{mf}$   
 $C_3$   $C_4$   $C_5$   $C_6$ —1000  $\mu\text{mf}$   
 $C_7$ —1000  $\mu\text{mf}$  Button Type  
 $C_8$ —1.5–7  $\mu\text{mf}$   
 $R_1$ —47 K  
 $R_2$ —270 K  
 $R_3$ —680 $\Omega$   
 $R_4$ —100 K

Typical Values for Channel No. 4  
 $L_1$ —5T No. 18 Wound Over  $L_2$   
 $L_2$ —16T No. 28  $\frac{1}{4}$ " Form Close-wound  
 $L_3$ —12T No. 18  $\frac{1}{4}$ " Form Close-wound  
 $L_4$ —3T No. 18  $\frac{1}{4}$ " Form Close-wound  
 $L_5$ —6T No. 28  $\frac{1}{4}$ " Form Close-wound  
 $L_6$ —5T No. 18 Wound Over  $L_5$   
 $L_1$  and  $L_6$  Are Center-tapped

All Resistors  $\frac{1}{2}$  Watt

## UHF-VHF TELEVISION TUNER

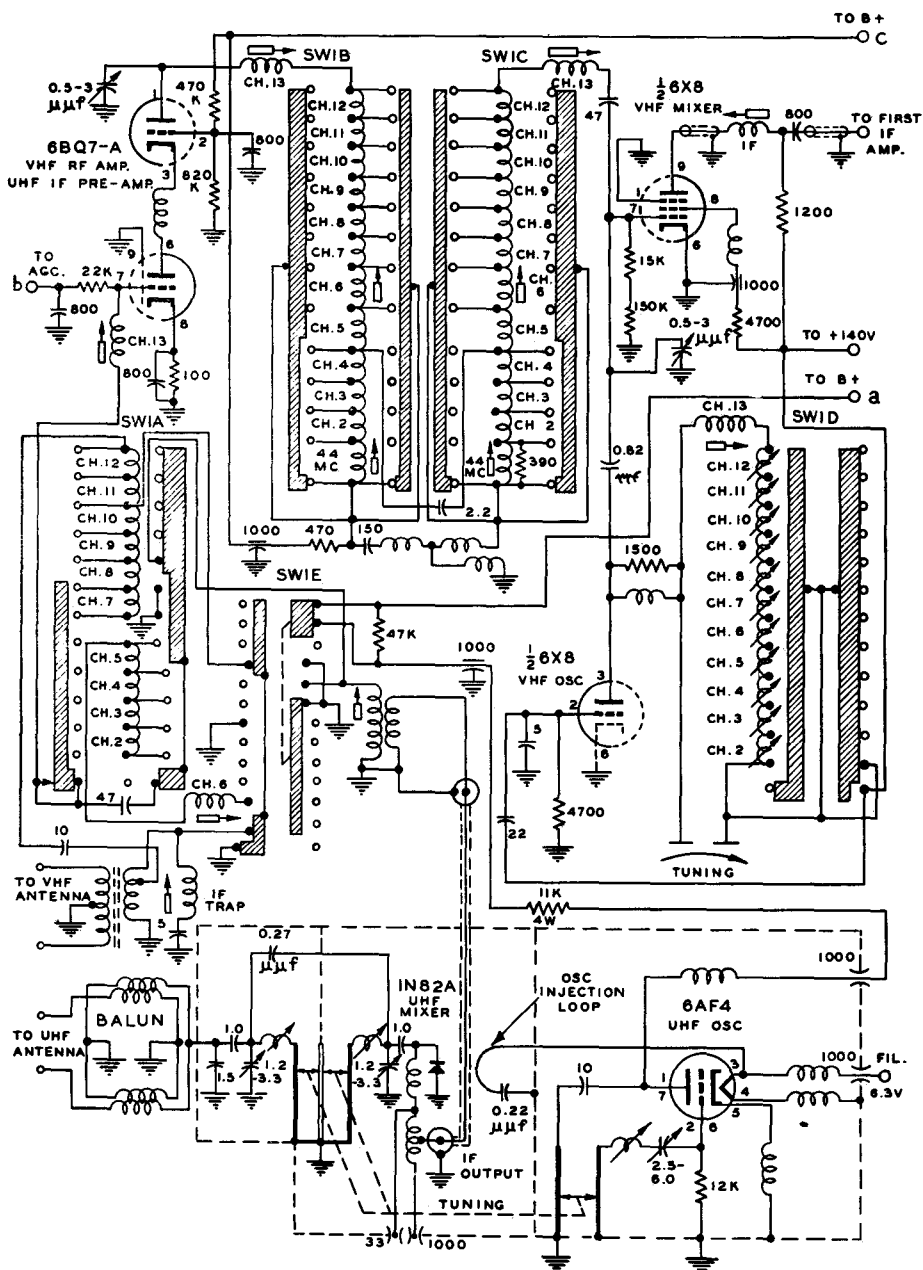

Unless Otherwise Noted

Capacitors 1 or more are in  $\mu\text{f}$

Capacitors less than 1 are in  $\mu\text{f}$

Resistors are  $\frac{1}{2}$  watt

(Switch S1 shown in UHF Position)



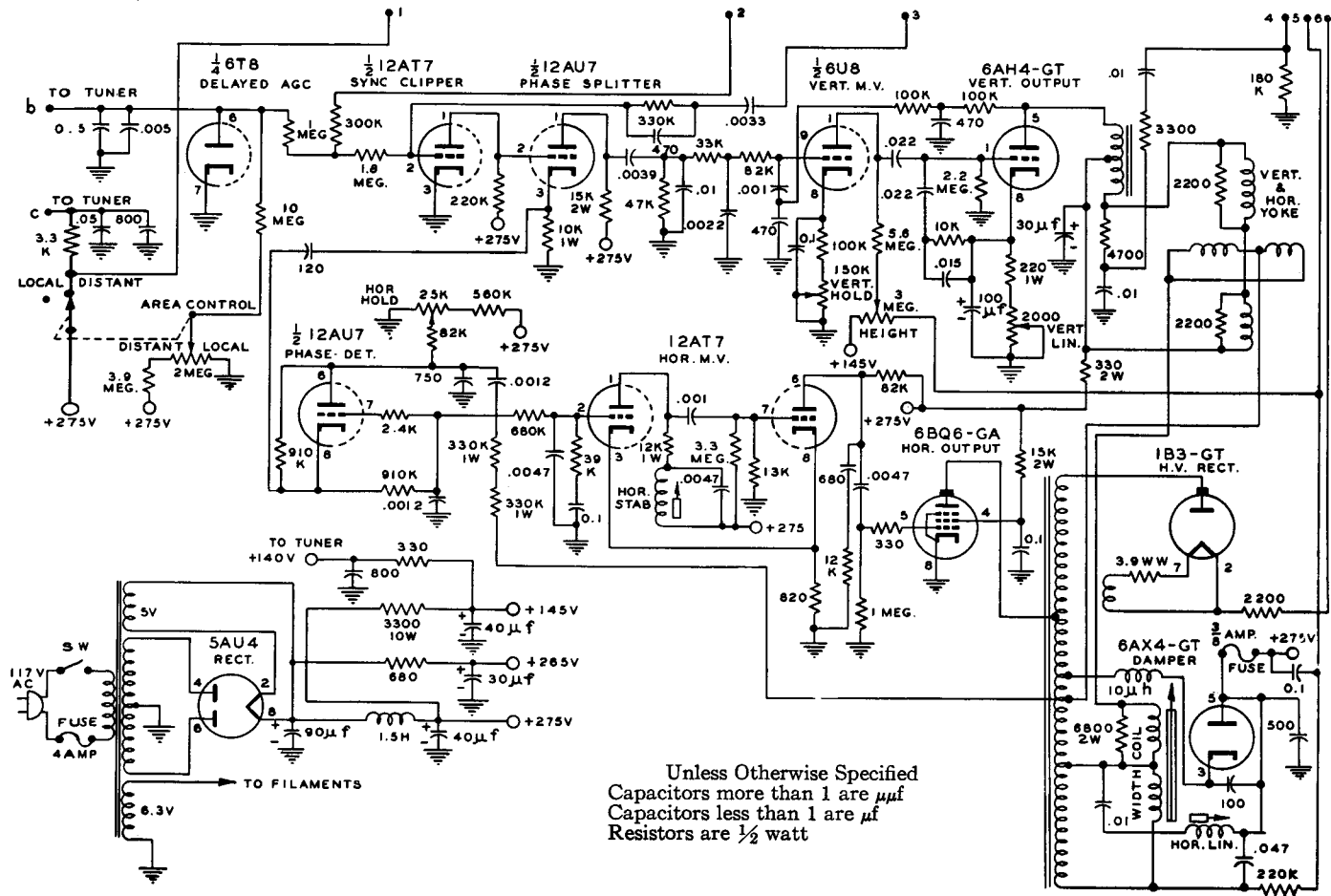

Unless Otherwise Specified  
 Capacitors more than 1 are  $\mu\mu\text{f}$   
 Capacitors less than 1 are  $\mu\text{f}$   
 Resistors are  $\frac{1}{2}$  watt

### THREE-WAY BATTERY PORTABLE

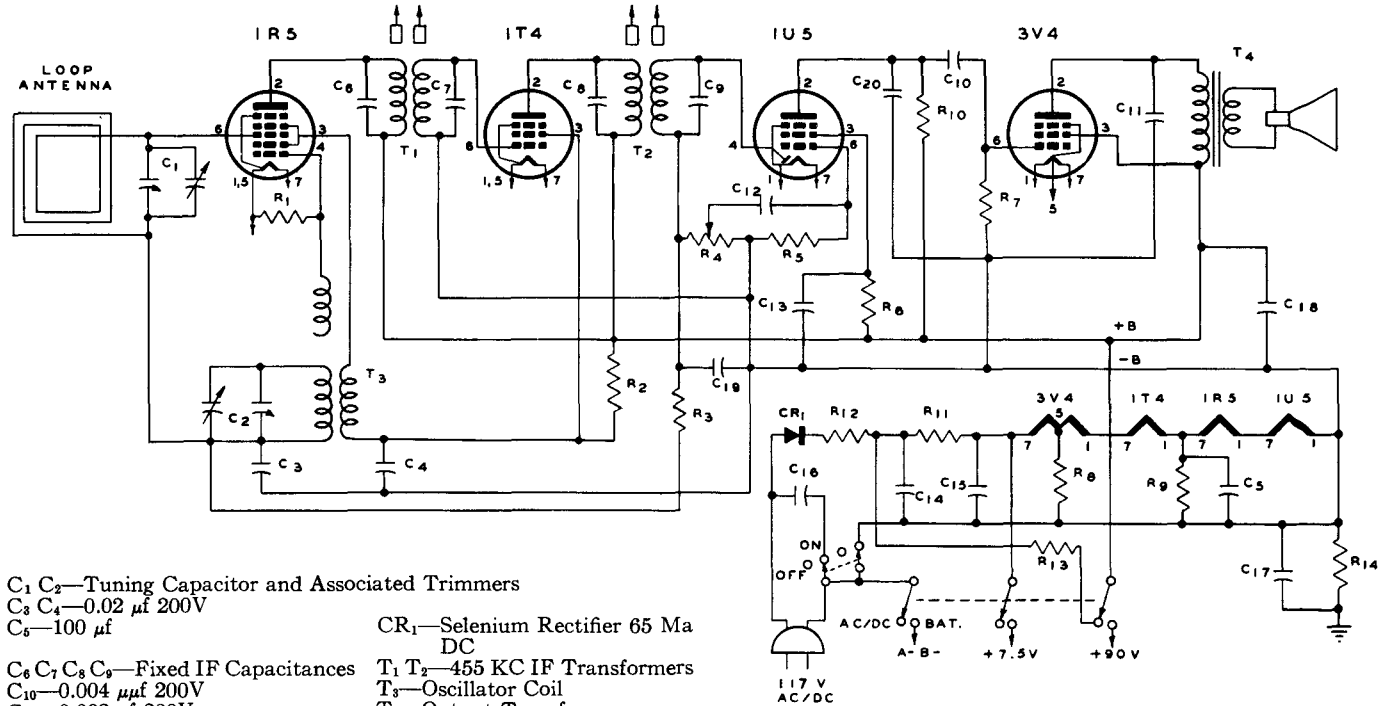

$C_1$   $C_2$ —Tuning Capacitor and Associated Trimmers

$C_3$   $C_4$ —0.02  $\mu\text{f}$  200V

$C_5$ —100  $\mu\text{f}$

$C_6$   $C_7$   $C_8$   $C_9$ —Fixed IF Capacitances

$C_{10}$ —0.004  $\mu\text{f}$  200V

$C_{11}$ —0.002  $\mu\text{f}$  200V

$C_{12}$ —0.002  $\mu\text{f}$  200V

$C_{13}$ —0.005  $\mu\text{f}$  200V

$C_{14}$ —40  $\mu\text{f}$  150V

$C_{15}$ —200  $\mu\text{f}$  20V

$C_{16}$   $C_{17}$ —0.05  $\mu\text{f}$  400V

$C_{18}$ —40  $\mu\text{f}$  250V

$C_{19}$ —330  $\mu\text{f}$

$C_{20}$ —220  $\mu\text{f}$

CR<sub>1</sub>—Selenium Rectifier 65 Ma  
DC

T<sub>1</sub> T<sub>2</sub>—455 KC IF Transformers

T<sub>3</sub>—Oscillator Coil

T<sub>4</sub>—Output Transformer

R<sub>1</sub>—100 K

R<sub>2</sub>—8200 $\Omega$

R<sub>4</sub>—500 K

R<sub>5</sub>—10 Meg

R<sub>3</sub> R<sub>6</sub> R<sub>7</sub>—3.3 Meg

R<sub>8</sub>—1500 $\Omega$

R<sub>9</sub>—680 $\Omega$

R<sub>10</sub>—470 K

R<sub>11</sub>—2300 $\Omega$

R<sub>12</sub>—68 $\Omega$  1 Watt

R<sub>13</sub>—2200 $\Omega$  1 Watt

R<sub>14</sub>—470 K

All Resistors 1/2 Watt Unless Otherwise Specified



## BATTERY-OPERATED PORTABLE

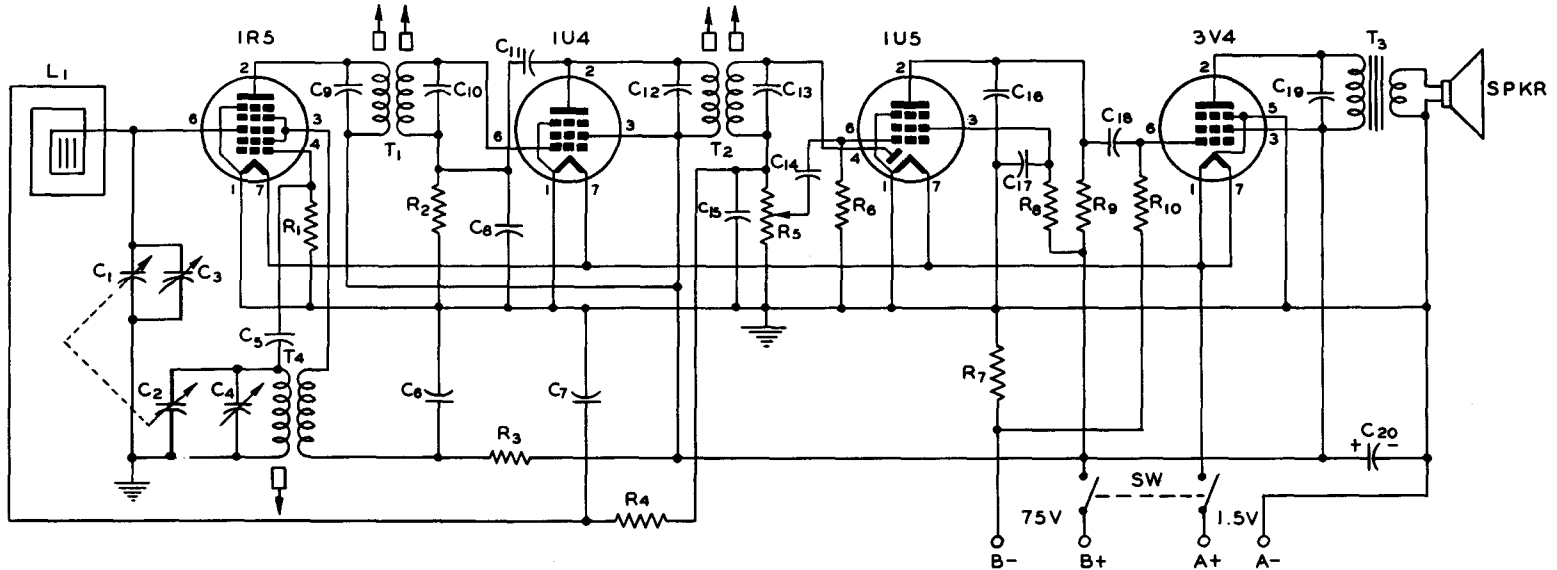

$R_1$ —100 K  
 $R_2$   $R_4$   $R_{10}$ —3.3 Meg  
 $R_3$ —15 K  
 $R_5$ —1 Meg Pot.  
 $R_6$ —10 Meg  
 $R_7$ —470 $\Omega$   
 $R_8$ —4.7 Meg  
 $R_9$ —1 Meg  
 $C_1$ —9—281  $\mu\text{mf}$   
 $C_2$ —8—110  $\mu\text{mf}$

$C_3$   $C_4$ —0—12  $\mu\text{mf}$   
 $C_5$ —47  $\mu\text{mf}$  500V  
 $C_6$ —0.01  $\mu\text{f}$  200V  
 $C_7$ —0.047  $\mu\text{f}$  200V  
 $C_8$ —0.003  $\mu\text{f}$  200V  
 $C_9$   $C_{12}$ —27  $\mu\text{mf}$  500V  
 $C_{10}$   $C_{13}$ —36  $\mu\text{mf}$  500V  
 $C_{11}$ —2.2  $\mu\text{mf}$  500V  
 $C_{14}$   $C_{19}$ —0.002  $\mu\text{f}$  200V  
 $C_{15}$ —82  $\mu\text{mf}$  500V

$C_{16}$ —220  $\mu\text{mf}$  500V  
 $C_{17}$ —0.022  $\mu\text{f}$  200V  
 $C_{18}$ —0.005  $\mu\text{f}$  200V  
 $C_{20}$ —10  $\mu\text{f}$  150V  
 $L_1$ —Antenna

$T_1$   $T_2$ —455 KC IF Transformer  
 $T_3$ —Output Transformer 10,000 $\Omega$  to Voice Coil  
 $T_4$ —Oscillator Transformer  
 SW—DPST On-Off Switch  
 All Resistors  $\frac{1}{2}$  Watt

# TYPICAL AC/DC AM-FM RECEIVER

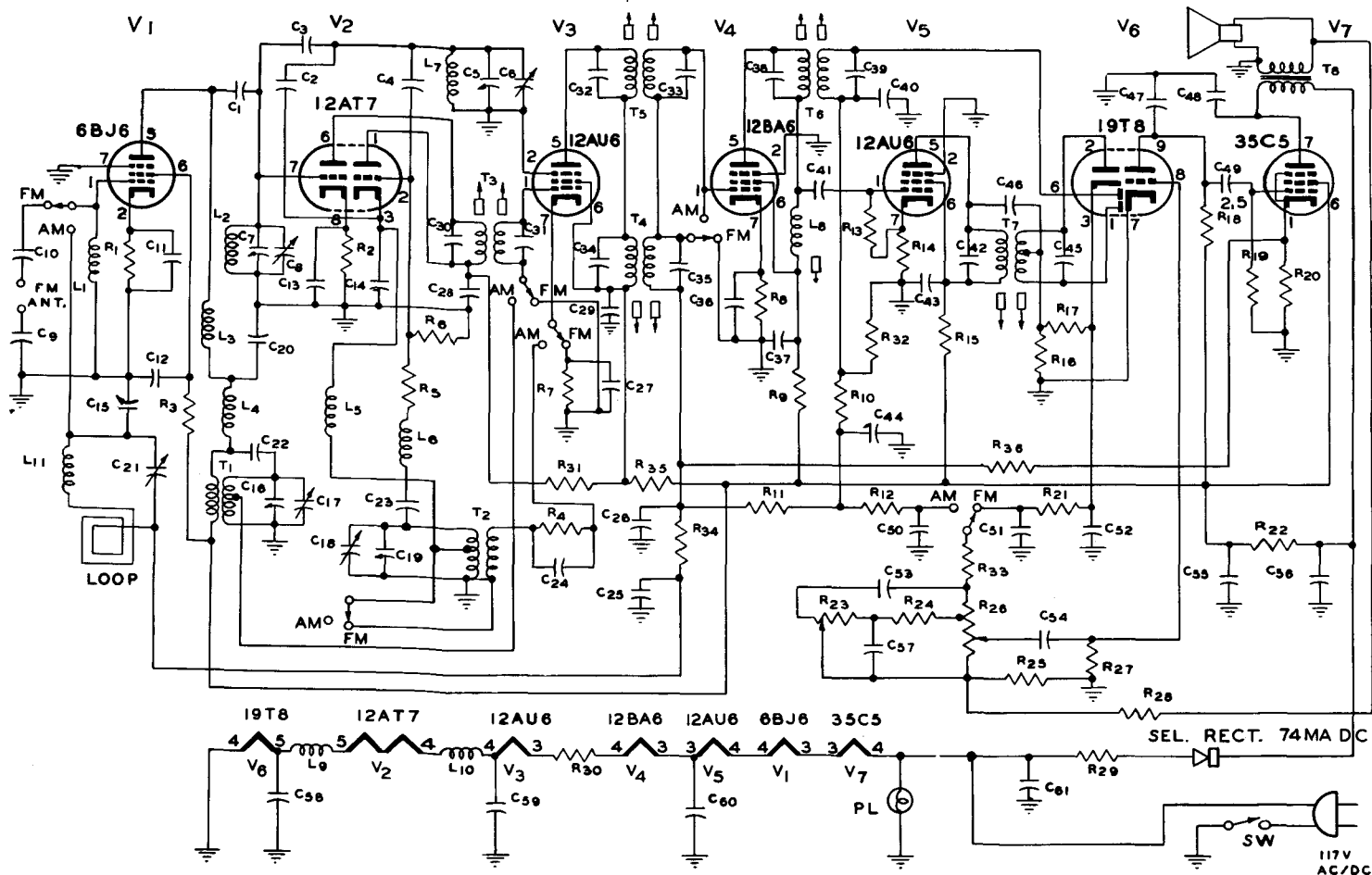

## PARTS LIST FOR AC/DC AM-FM RECEIVER

C <sub>1</sub> —10 $\mu\mu\text{f}$	C <sub>39</sub> —131 $\mu\mu\text{f}$	R <sub>18</sub> R <sub>19</sub> —470 K
C <sub>2</sub> —22 $\mu\mu\text{f}$	C <sub>40</sub> C <sub>44</sub> —100 $\mu\mu\text{f}$	R <sub>20</sub> —150 $\Omega$
C <sub>3</sub> C <sub>22</sub> —1.5 $\mu\mu\text{f}$	C <sub>41</sub> C <sub>45</sub> C <sub>46</sub> —33 $\mu\mu\text{f}$	R <sub>22</sub> —1000 $\Omega$ 2 Watt WW
C <sub>4</sub> C <sub>23</sub> —20 $\mu\mu\text{f}$	C <sub>42</sub> —50 $\mu\mu\text{f}$	R <sub>23</sub> —4 Meg Tone Control
C <sub>5</sub> C <sub>6</sub> C <sub>7</sub> C <sub>8</sub> —FM Tuning Capacitor and Trimmers	C <sub>47</sub> C <sub>50</sub> —47 $\mu\mu\text{f}$	R <sub>25</sub> —2 Meg Vol Control (1 Meg Tap)
C <sub>9</sub> C <sub>11</sub> C <sub>12</sub> C <sub>32</sub> —470 $\mu\mu\text{f}$	C <sub>51</sub> —0.001 $\mu\text{f}$	R <sub>27</sub> —6.8 Meg
C <sub>10</sub> —6 $\mu\mu\text{f}$	C <sub>53</sub> —0.002 $\mu\text{f}$	R <sub>29</sub> —22 $\Omega$ 1 Watt
C <sub>13</sub> —0.0015 $\mu\text{f}$	C <sub>55</sub> —40 $\mu\text{f}$	R <sub>30</sub> —33 $\Omega$ 2 Watt WW
C <sub>14</sub> —18 $\mu\mu\text{f}$	C <sub>56</sub> —80 $\mu\text{f}$	R <sub>32</sub> —R <sub>34</sub> —220 K
C <sub>15</sub> C <sub>16</sub> C <sub>17</sub> C <sub>18</sub> C <sub>19</sub> —AM Tuning Capacitors and Trimmers	C <sub>57</sub> —0.003 $\mu\text{f}$	R <sub>35</sub> —10 Meg
C <sub>20</sub> —82 $\mu\mu\text{f}$	PL—110-Volt Pilot Lamp	T <sub>1</sub> —Broadcast RF Coil
C <sub>21</sub> —2—20 $\mu\mu\text{f}$ Trimmer	R <sub>1</sub> R <sub>5</sub> R <sub>7</sub> R <sub>8</sub> R <sub>25</sub> —100 $\Omega$	T <sub>2</sub> —Broadcast Oscillator Coil
C <sub>24</sub> C <sub>49</sub> C <sub>54</sub> —0.01 $\mu\text{f}$	R <sub>2</sub> —1500 $\Omega$	T <sub>3</sub> T <sub>5</sub> —10.7 Mc FM IF Transformer
C <sub>25</sub> C <sub>26</sub> C <sub>31</sub> —0.05 $\mu\text{f}$	R <sub>3</sub> R <sub>31</sub> R <sub>35</sub> —220 $\Omega$	T <sub>4</sub> T <sub>6</sub> —455 KC IF Transformer
C <sub>27</sub> C <sub>28</sub> C <sub>29</sub> C <sub>36</sub> C <sub>37</sub> C <sub>43</sub> C <sub>48</sub> C <sub>58</sub> C <sub>59</sub> C <sub>60</sub> —0.005 $\mu\text{f}$	R <sub>4</sub> —2.2 K	T <sub>7</sub> —10.7 Mc Discriminator Transformer
C <sub>30</sub> C <sub>31</sub> —40 $\mu\mu\text{f}$	R <sub>5</sub> —27 K	T <sub>8</sub> —Output Transformer
C <sub>32</sub> C <sub>35</sub> —17 $\mu\mu\text{f}$	R <sub>9</sub> R <sub>28</sub> —470 $\Omega$	L <sub>1</sub> —FM Antenna Choke
C <sub>34</sub> —107 $\mu\mu\text{f}$	R <sub>10</sub> R <sub>12</sub> R <sub>33</sub> —47 K	L <sub>2</sub> —FM RF Coil
C <sub>35</sub> —73 $\mu\mu\text{f}$	R <sub>11</sub> —2.2 Meg	L <sub>3</sub> —RF Plate Choke
C <sub>36</sub> —106 $\mu\mu\text{f}$	R <sub>13</sub> R <sub>21</sub> R <sub>24</sub> —100 K	L <sub>4</sub> L <sub>5</sub> L <sub>6</sub> L <sub>11</sub> —RF Choke 2.2 $\mu\text{H}$
	R <sub>14</sub> —180 $\Omega$	L <sub>7</sub> —FM Oscillator Coil
	R <sub>15</sub> —22 K	L <sub>8</sub> —10.7 Mc 3rd FM IF Coil
	R <sub>16</sub> R <sub>17</sub> —120 K	L <sub>9</sub> L <sub>10</sub> —RF Choke

# PREAMPLIFIER AND CONTROL UNIT FOR USE WITH HIGH-FIDELITY AUDIO AMPLIFIER

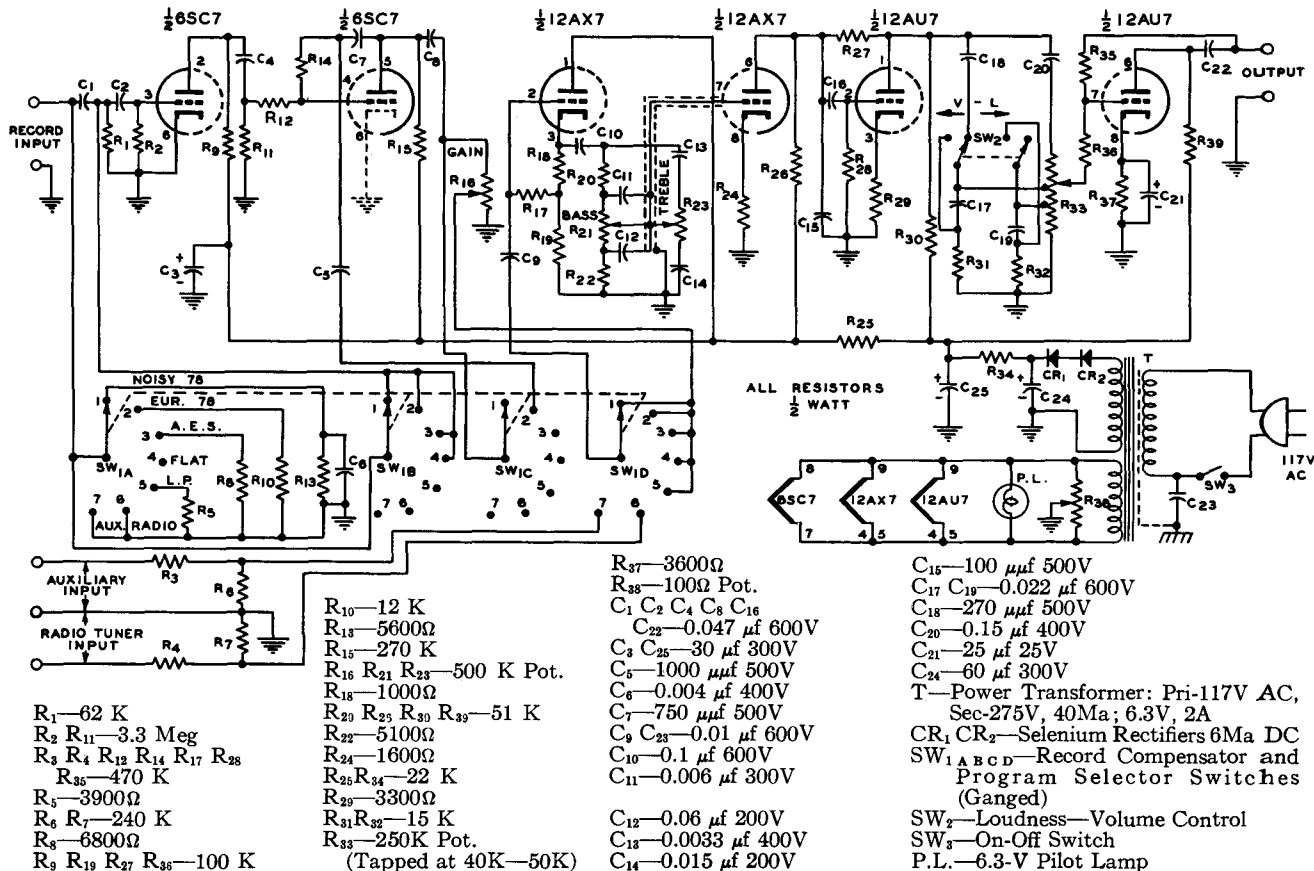

$R_1$ —62 K  
 $R_2$   $R_{11}$ —3.3 Meg  
 $R_3$   $R_4$   $R_{12}$   $R_{14}$   $R_{17}$   $R_{25}$   
 $R_{35}$ —470 K  
 $R_5$ —3900 $\Omega$   
 $R_6$   $R_7$ —240 K  
 $R_8$ —6800 $\Omega$   
 $R_9$   $R_{19}$   $R_{27}$   $R_{36}$ —100 K

$R_{10}$ —12 K  
 $R_{13}$ —5600 $\Omega$   
 $R_{15}$ —270 K  
 $R_{16}$   $R_{21}$   $R_{23}$ —500 K Pot.  
 $R_{18}$ —1000 $\Omega$   
 $R_{20}$   $R_{25}$   $R_{30}$   $R_{39}$ —51 K  
 $R_{22}$ —5100 $\Omega$   
 $R_{24}$ —1600 $\Omega$   
 $R_{25}$   $R_{34}$ —22 K  
 $R_{29}$ —3300 $\Omega$   
 $R_{31}$   $R_{32}$ —15 K  
 $R_{33}$ —250K Pot.  
 (Tapped at 40K—50K)

$R_{37}$ —3600 $\Omega$   
 $R_{38}$ —100 $\Omega$  Pot.  
 $C_1$   $C_2$   $C_4$   $C_8$   $C_{16}$   
 $C_{22}$ —0.047  $\mu$ f 600V  
 $C_3$   $C_{25}$ —30  $\mu$ f 300V  
 $C_5$ —1000  $\mu$ f 500V  
 $C_6$ —0.004  $\mu$ f 400V  
 $C_7$ —750  $\mu$ f 500V  
 $C_9$   $C_{23}$ —0.01  $\mu$ f 600V  
 $C_{10}$ —0.1  $\mu$ f 600V  
 $C_{11}$ —0.006  $\mu$ f 300V  
 $C_{12}$ —0.06  $\mu$ f 200V  
 $C_{13}$ —0.0033  $\mu$ f 400V  
 $C_{14}$ —0.015  $\mu$ f 200V

$C_{15}$ —100  $\mu$ f 500V  
 $C_{17}$   $C_{19}$ —0.022  $\mu$ f 600V  
 $C_{18}$ —270  $\mu$ f 500V  
 $C_{20}$ —0.15  $\mu$ f 400V  
 $C_{21}$ —25  $\mu$ f 25V  
 $C_{24}$ —60  $\mu$ f 300V  
 $T$ —Power Transformer: Pri-117V AC,  
 Sec-275V, 40Ma; 6.3V, 2A  
 $CR_1$   $CR_2$ —Selenium Rectifiers 6Ma DC  
 $SW_1$  A B C D—Record Compensator and  
 Program Selector Switches  
 (Ganged)  
 $SW_2$ —Loudness—Volume Control  
 $SW_3$ —On-Off Switch  
 P.L.—6.3-V Pilot Lamp

## 10-WATT HIGH-FIDELITY AUDIO AMPLIFIER

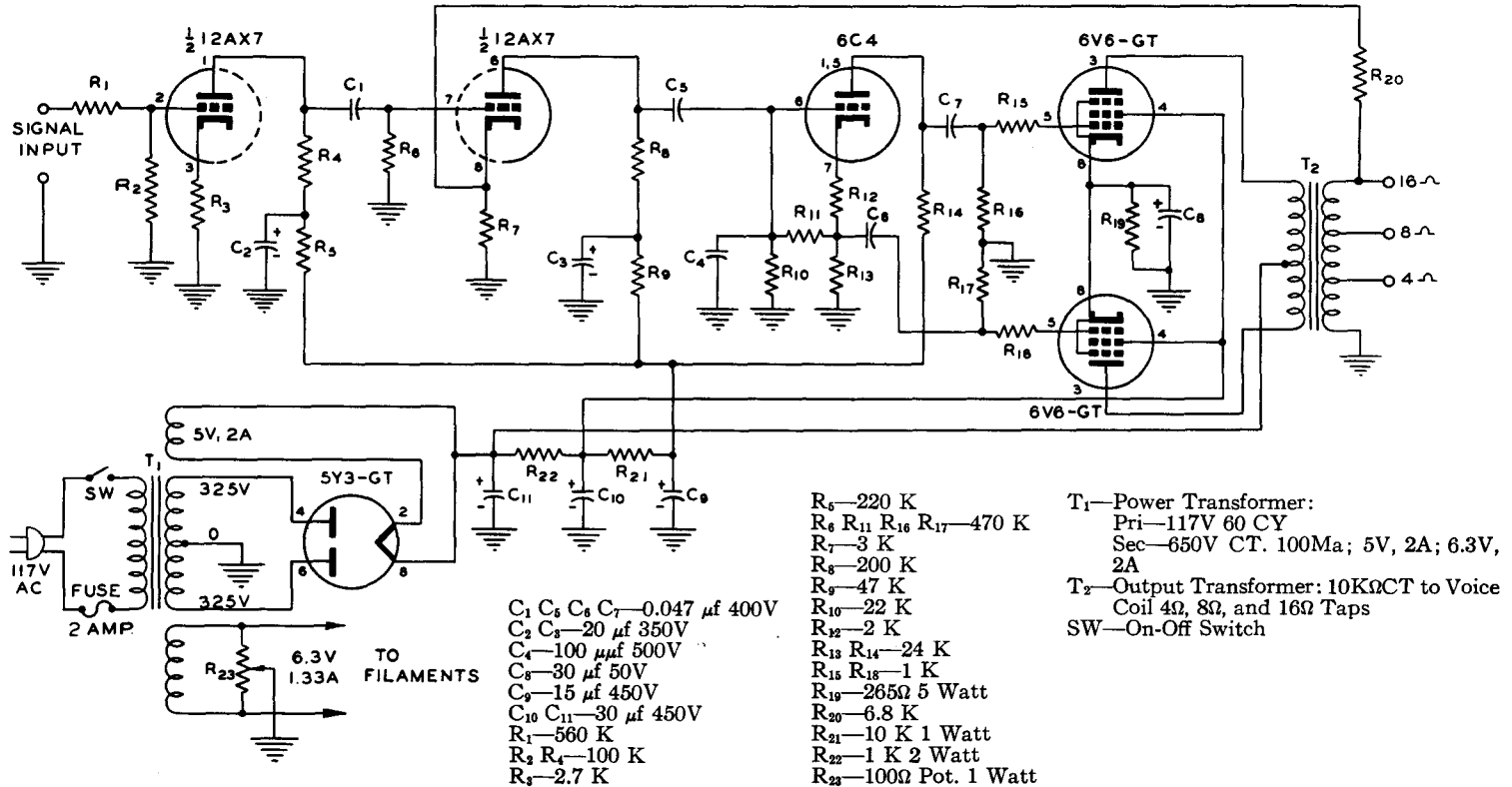

All Resistors  $\frac{1}{2}$  Watt Unless Otherwise Specified

# AUTOMOBILE RADIO RECEIVER

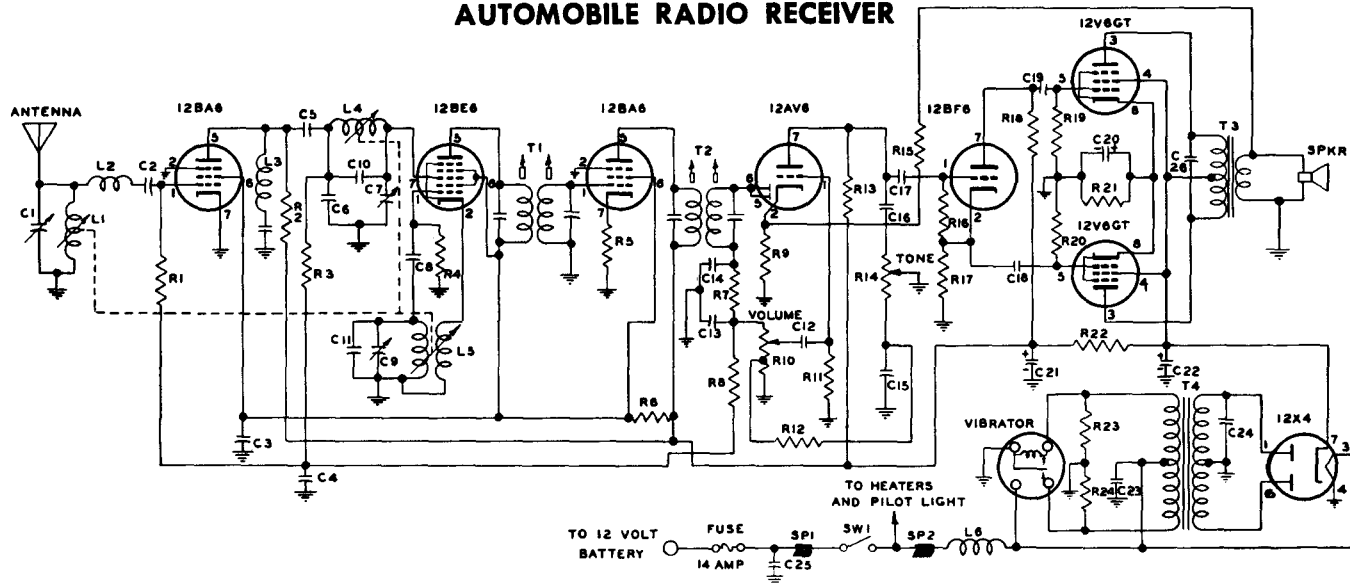

- C1 C7 C9—Trimmer Capacitors
- C2—27  $\mu\text{f}$
- C3 C4—0.05  $\mu\text{f}$  400V
- C5—68  $\mu\text{f}$
- C6—265  $\mu\text{f}$
- C8—47  $\mu\text{f}$
- C10—56  $\mu\text{f}$
- C11—100  $\mu\text{f}$
- C12—0.006  $\mu\text{f}$  400V
- C13 C14—100  $\mu\text{f}$
- C15—0.25  $\mu\text{f}$  400V
- C16—0.004  $\mu\text{f}$  400V
- C17—0.005  $\mu\text{f}$  400V
- C18 C19—0.01  $\mu\text{f}$  600V
- C20—20  $\mu\text{f}$  25V

- C21 C22—20  $\mu\text{f}$  450V
- C23 C25—0.5  $\mu\text{f}$  100V
- C24—0.02  $\mu\text{f}$  1600V
- C26—0.003  $\mu\text{f}$  600V
- L1 L4—RF Coils
- L2—RF Choke, 80  $\mu\text{H}$
- L3—IF Trap
- L5—Osc. Coil
- L6—Vibrator Hash Choke
- R1 R19 R20—470 K
- R2—10 K 1Watt
- R3—330 K
- R4 R7—47 K
- R5—220 $\Omega$
- R6—12 K 1Watt

- R8—1 Meg
- R9—47 $\Omega$
- R10—250 K Pot. Tapped at 125 K
- R11 R16—10 Meg
- R12—22 K
- R13 R17 R18—220 K
- R14—1 Meg Pot.
- R15—1.5 K
- R21—330 $\Omega$  2Watt
- SW1—On-Off Switch
- SP1 SP2—Spark Plate Capacitors
- T1 T2—262KC IF Transformers
- T3—Output Transformer
- T4—Power Transformer

All resistors  $\frac{1}{2}$  watt unless otherwise specified

### 30-WATT CLASS AB<sub>2</sub> AUDIO AMPLIFIER

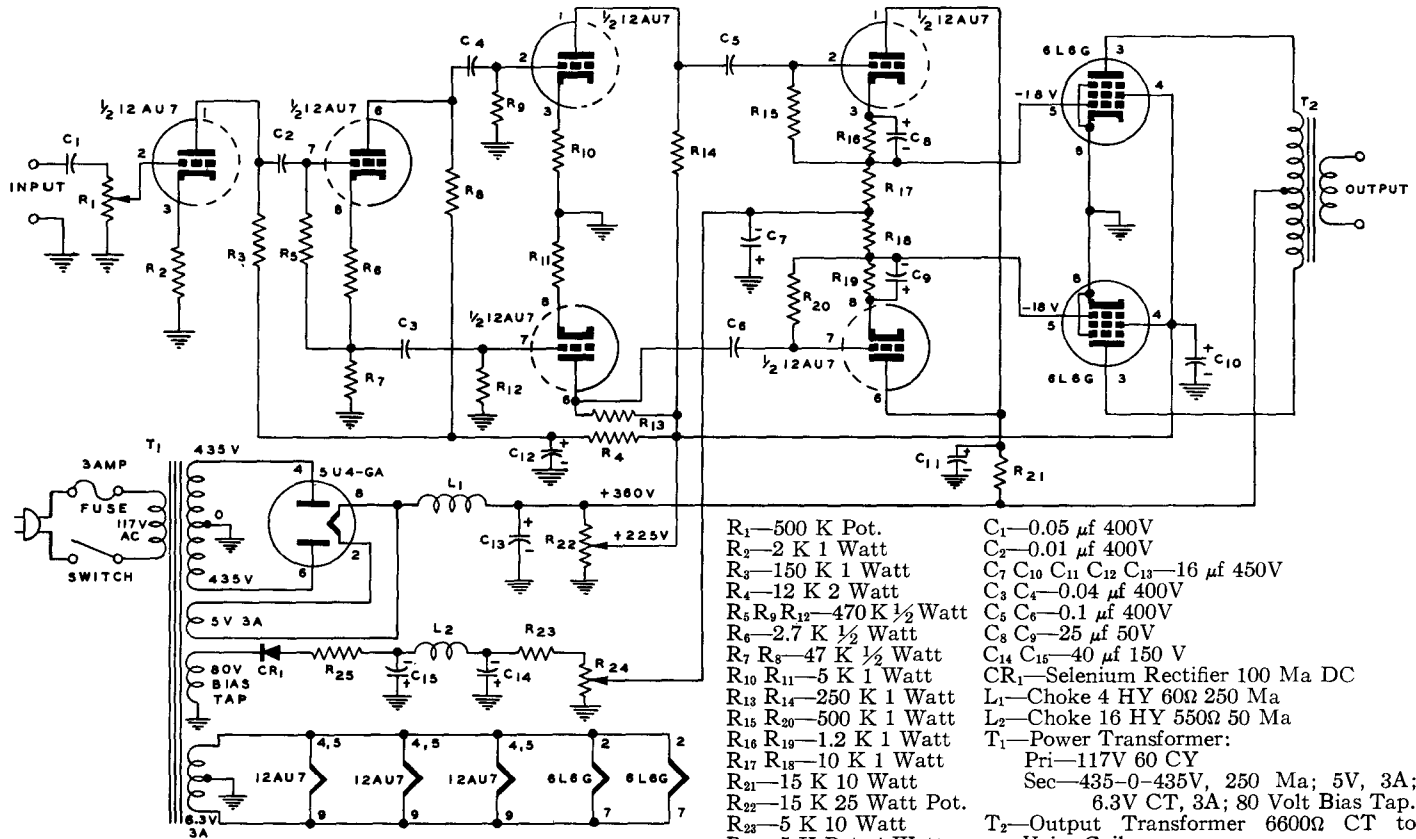

- R<sub>1</sub>—500 K Pot.
- R<sub>2</sub>—2 K 1 Watt
- R<sub>3</sub>—150 K 1 Watt
- R<sub>4</sub>—12 K 2 Watt
- R<sub>5</sub> R<sub>9</sub> R<sub>12</sub>—470 K 1/2 Watt
- R<sub>6</sub>—2.7 K 1/2 Watt
- R<sub>7</sub> R<sub>8</sub>—47 K 1/2 Watt
- R<sub>10</sub> R<sub>11</sub>—5 K 1 Watt
- R<sub>13</sub> R<sub>14</sub>—250 K 1 Watt
- R<sub>15</sub> R<sub>20</sub>—500 K 1 Watt
- R<sub>16</sub> R<sub>19</sub>—1.2 K 1 Watt
- R<sub>17</sub> R<sub>18</sub>—10 K 1 Watt
- R<sub>21</sub>—15 K 10 Watt
- R<sub>22</sub>—15 K 25 Watt Pot.
- R<sub>23</sub>—5 K 10 Watt
- R<sub>24</sub>—5 K Pot. 4 Watt
- R<sub>25</sub>—22Ω 1 Watt
- C<sub>1</sub>—0.05 μf 400V
- C<sub>2</sub>—0.01 μf 400V
- C<sub>3</sub> C<sub>4</sub>—0.04 μf 400V
- C<sub>5</sub> C<sub>6</sub>—0.1 μf 400V
- C<sub>7</sub> C<sub>10</sub> C<sub>11</sub> C<sub>12</sub> C<sub>13</sub>—16 μf 450V
- C<sub>8</sub> C<sub>9</sub>—25 μf 50V
- C<sub>14</sub> C<sub>15</sub>—40 μf 150 V
- CR<sub>1</sub>—Selenium Rectifier 100 Ma DC
- L<sub>1</sub>—Choke 4 HY 60Ω 250 Ma
- L<sub>2</sub>—Choke 16 HY 550Ω 50 Ma
- T<sub>1</sub>—Power Transformer:  
Pri—117V 60 CY  
Sec—435-0-435V, 250 Ma; 5V, 3A;  
6.3V CT, 3A; 80 Volt Bias Tap.
- T<sub>2</sub>—Output Transformer 6600Ω CT to  
Voice Coil

## FM TUNER

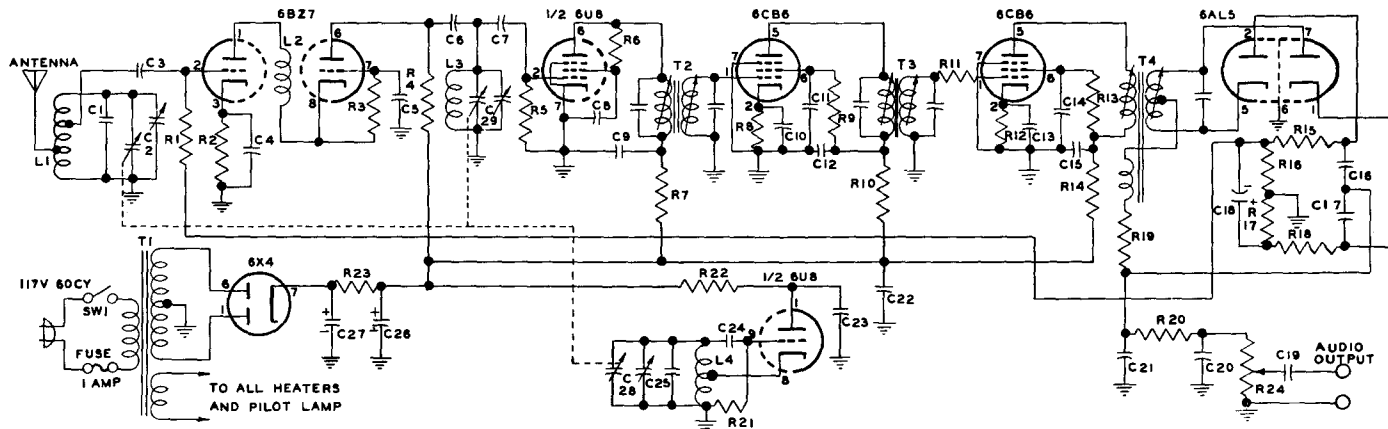

C1—12  $\mu\text{f}$   
 C2 C28 C29—Tuning Capacitors  
 and Associated Trimmers  
 C3 C7 C24—47  $\mu\text{f}$   
 C4 C5 C8 C20 C23—0.001  $\mu\text{f}$   
 C6—3.3  $\mu\text{f}$   
 C9 C10 C11 C12 C13 C14 C15 C22—  
 0.005  $\mu\text{f}$   
 C16 C17 C21—270  $\mu\text{f}$   
 C18—10  $\mu\text{f}$  50V  
 C19—0.05  $\mu\text{f}$   
 C25—10  $\mu\text{f}$   
 C26 C27—20  $\mu\text{f}$  350V

L1—Antenna Coil  
 L2 L3—RF Coils  
 L4—Oscillator Coil  
 R1 R3—470 K  
 R2 R12 R19—68 $\Omega$   
 R4 R7—10 K  
 R5—1 Meg  
 R6—100 K  
 R8—150 $\Omega$   
 R9 R13 R20—68 K  
 R10 R14—2.2 K  
 R11—47 $\Omega$   
 R15—1.5 K

R16 R17 R22—6.8 K  
 R18—1 K  
 R21—22 K  
 R23—1.5 K 5Watt  
 R24—1 Meg Pot.  
 SW1—On-Off Switch  
 T1—Power Transformer:  
 Pri—117V, 60CY  
 Sec—480V CT, 50Ma; 6.3V,  
 2.5A  
 T2 T3—10.7 Mc IF Transformers  
 T4—10.7 Mc Ratio Detector  
 Transformer

All resistors  $\frac{1}{2}$  watt unless otherwise specified



## 20-WATT HIGH-FIDELITY PREAMPLIFIER AND AMPLIFIER

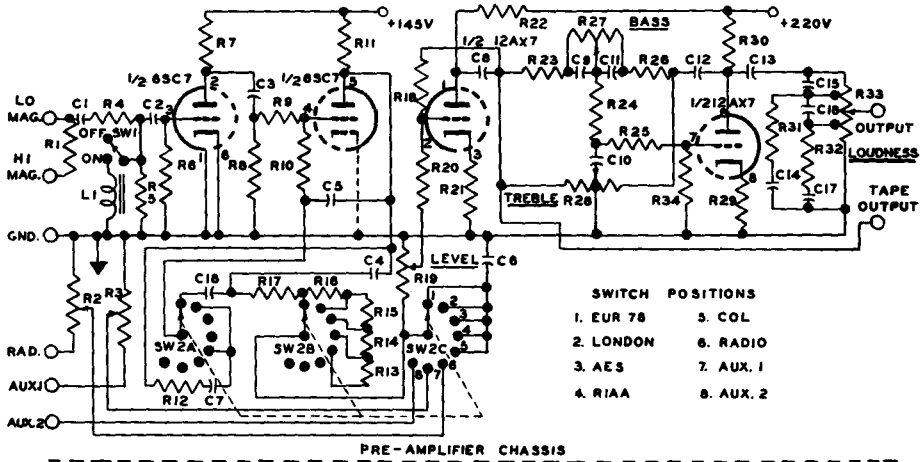

### SWITCH POSITIONS

- |           |           |
|-----------|-----------|
| 1. EUR 78 | 5. COL    |
| 2. LONDON | 6. RADIO  |
| 3. AES    | 7. AUX. 1 |
| 4. RIAA   | 8. AUX. 2 |

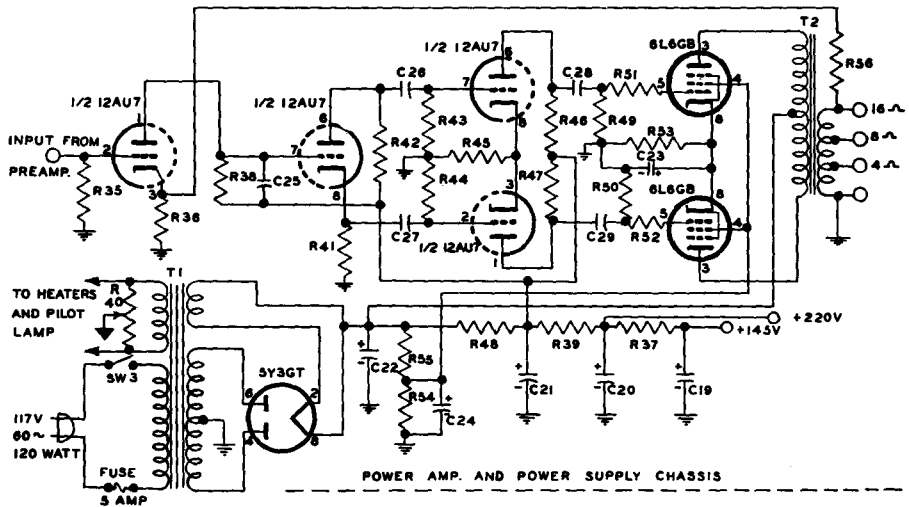

C1—2  $\mu$ f 100V  
 C2 C3 C4 C28 C29—.0047  $\mu$ f 400V  
 C5—750  $\mu$ f 400V  
 C6—.0002  $\mu$ f 400V  
 C7—.01  $\mu$ f 400V  
 C8 C12 C26 C27—.1  $\mu$ f 400V  
 C9 C11—.0047  $\mu$ f 400V  
 C10 C16 C25—100  $\mu$ f 400V  
 C13—.0022  $\mu$ f 400V  
 C14 C17—.0045  $\mu$ f 400V  
 C15—200  $\mu$ f 400V  
 C18—.001  $\mu$ f 400V  
 C19 C20—30  $\mu$ f 350V  
 C21 C22—40  $\mu$ f 450V  
 C23—100  $\mu$ f 50V  
 C24—5  $\mu$ f 350V  
 L1—4 H 4000  
 R1 R6 R20 R22 R23 R26—100 K  
 R2 R3—500 K Pot.  
 R4—5100  
 R5 R6—3.3 Meg  
 R7 R11—270 K  
 R8 R9 R10 R24 R30 R34 R35—470 K  
 R12—2.7 Meg  $\pm$ 5%  
 R13—62 K  $\pm$ 5%  
 R14 R41 R42—24 K  $\pm$ 5%  
 R15—20 K  $\pm$ 5%  
 R16—15 K  $\pm$ 5%  
 R17—10 K  $\pm$ 5%  
 R18—1.5 Meg  
 R19 R27—1 Meg Pot.  
 R21—6800

R25 R51 R52—1 K  
 R28—500 K Pot. CT  
 R29—3 K  
 R31 R32—50 K  
 R33—5 Meg Pot. Tapped at 175 K and 310 K  
 R36—1.6 K  
 R37—120 K  
 R38—100 K 1Watt  
 R39—22 K  
 R40—1000 Pot.  
 R43 R44—1 Meg  
 R45—1.5 K  
 R46 R47 R56—20 K  
 R48—10 K 2Watt  
 R49 R50—150 K  
 R53—2500 5Watt  
 R55—7.5 K 2Watt  
 R54—25 K 5Watt  
 SW1—Rumble Filter Switch  
 SW2ABC—Record Compensator and Input Selector Switch  
 SW3—On-Off Switch  
 T1—Power Transformer: Pri—117V, 60CY, 120Watt  
                                   Sec—700V CT  
                                   115 Ma; 6.3V, 4A;  
                                   5V, 2A  
 T2—Output Transformer: Pri—90000 CT  
                                   Sec—4, 8, 160 VC

All resistors  $\frac{1}{2}$  watt,  $\pm$ 10% unless otherwise specified

# CONSTRUCTION DATA FOR LOUDSPEAKER ENCLOSURES

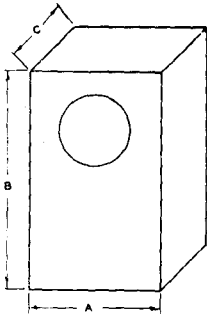

CHOOSE DIMENSIONS TO FIT AVAILABLE SPACE AND TO PROVIDE 6 OR 10 CU. FT. ENCLOSED VOLUME AS DESIRED

A = AT LEAST 1/2 B  
 C = 12" MIN INSIDE (APPROX 18" TO 18" PREFERRED)

RECTANGULAR ENCLOSURES

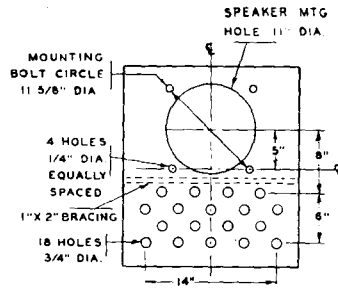

DRILLING PLAN 6 CU. FT. ENCLOSURE

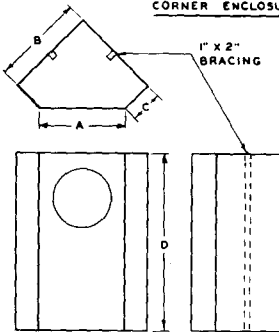

CORNER ENCLOSURES

DRILLING PLAN 10 CU. FT. ENCLOSURE

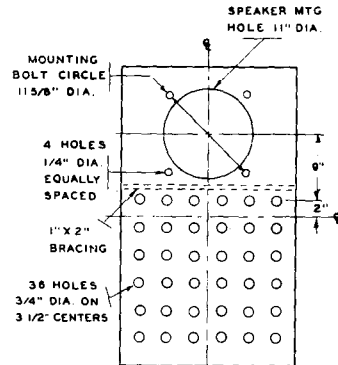

OUTSIDE DIMENSIONS	6 CU. FT.
A	24"
B	25 1/2"
C	8 1/2"
D	25 1/2"
	10 CU. FT.
A	24"
B	25 1/2"
C	8 1/2"
D	40"

**Notes:**

Use plywood at least 1/2" thick for 6 cu ft size, and 5/8" thick for 10 cu ft size. Line back, bottom, and one side of rectangular enclosure, and bottom and two back sides of corner enclosure with one to two inches of soft acoustic material, such as fiberglass. Glue all joints. Make back or front removable if speaker is to be mounted on inside surface of mounting board.

Recommended Speakers—G-E A1-400 (40-15000 CPS) or 1201A or 1203A (50-13000 CPS)

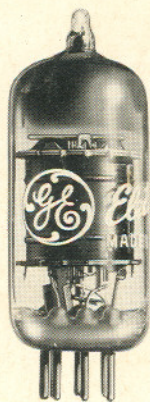

ELECTRONIC COMPONENTS DIVISION

**GENERAL**  **ELECTRIC**

Schenectady 5, N. Y.